

MBQUART[®]

MUSIC. DEFINED.

MDR2.0 USER MANUAL

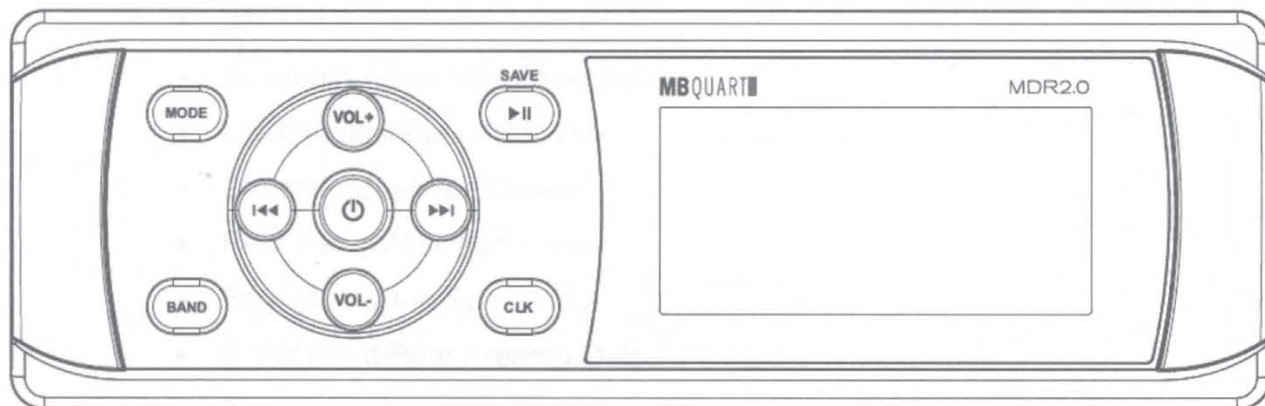

AM/FM • Bluetooth[®] • USB • iPhone/iPod
IPX5-Rated Media Receiver

PRE-INSTALLATION CHECKLIST

Thank you for purchasing the MB Quart MDR2.0 Multimedia Receiver with AM/FM, USB, iPhone/iPod control and Bluetooth audio streaming. Please take a few minutes to review the user manual before attempting installation and operation.

Additional support documentation can be found at MBQUART.com or by emailing support@maxxsonics.com.

FEATURES

- IPX5 Rated for Outdoor Use
- DIN Standard Chassis
- AM/FM Radio (selectable USA/Europe)
- Bluetooth Audio Streaming (HSP)
- USB Audio Input (MP3/WMA)
- Direct iPhone/iPod Control
- Rear Panel AUX Audio Input
- Four (4) Built-In Speaker Outputs
- 4 Volt Front/Rear Preamp Outputs for External Amplifiers

CHECKLIST

1. Please read the instruction manual carefully before installing the unit.
2. Please note this unit is intended for only 12V DC electrical systems.
3. Make connections to the unit as outlined in this instruction manual. Incorrect connections may cause damage to the unit.
4. Make sure to connect and insulate all wires before powering on the unit.
5. Secure any loose wires after installation.

WIRING & INSTALLATION

REAR PANEL DETAIL

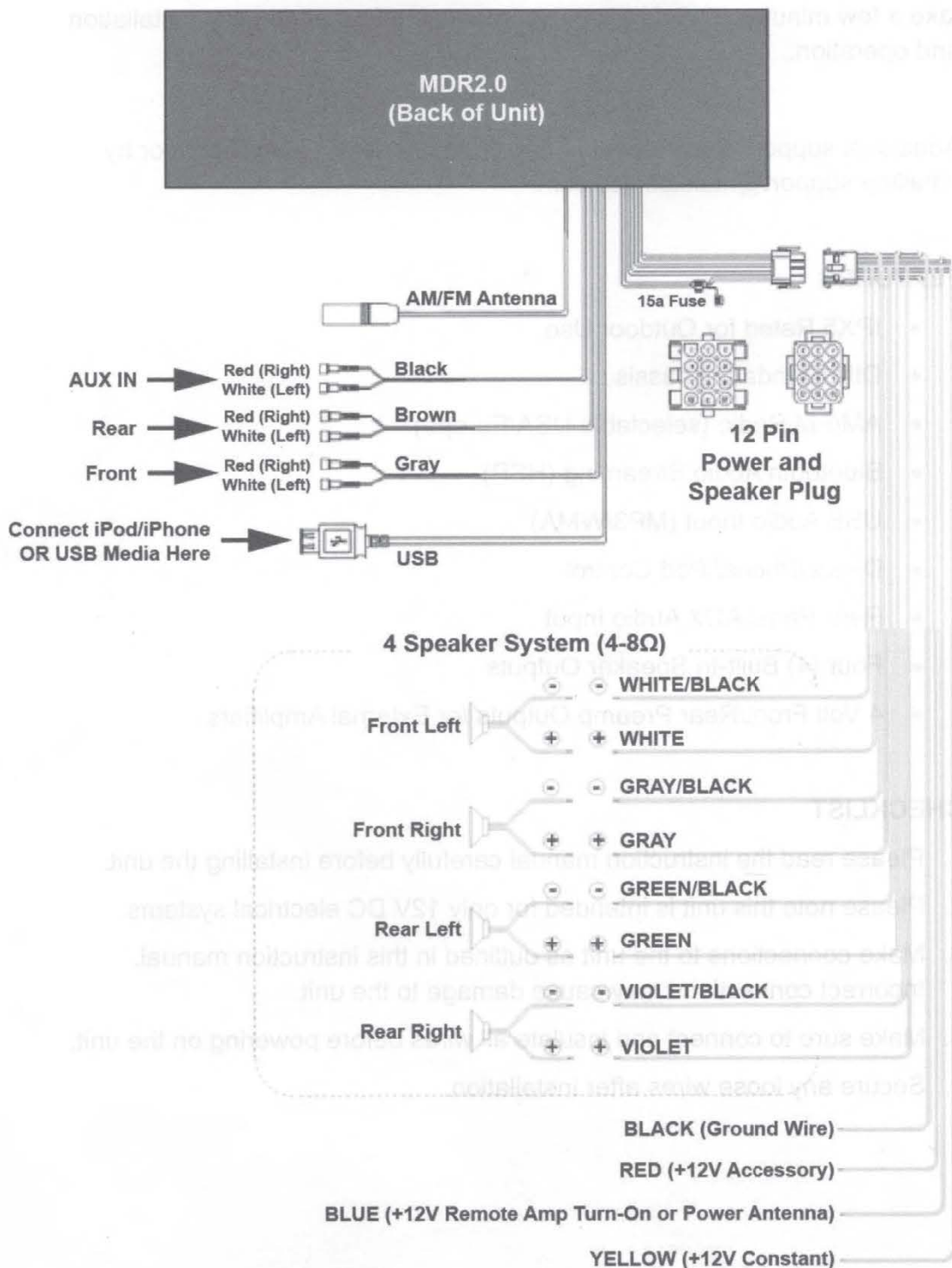

WIRING & INSTALLATION

INSTALL THE UNIT

- *Please note: This unit requires a minimum 3-3/4" mounting depth which includes space for the electrical/speaker plugs and any A/V input and output connections.*
1. Cut or utilize a mounting opening 7"(H) x 2" W).
 2. Remove the left and right decorative covers as shown in the diagram.
 3. Insert the unit into the mounting opening.
 4. Attach the unit using the four (4) supplied mounting screws.
 5. Replace decorative side covers over mounting screws.

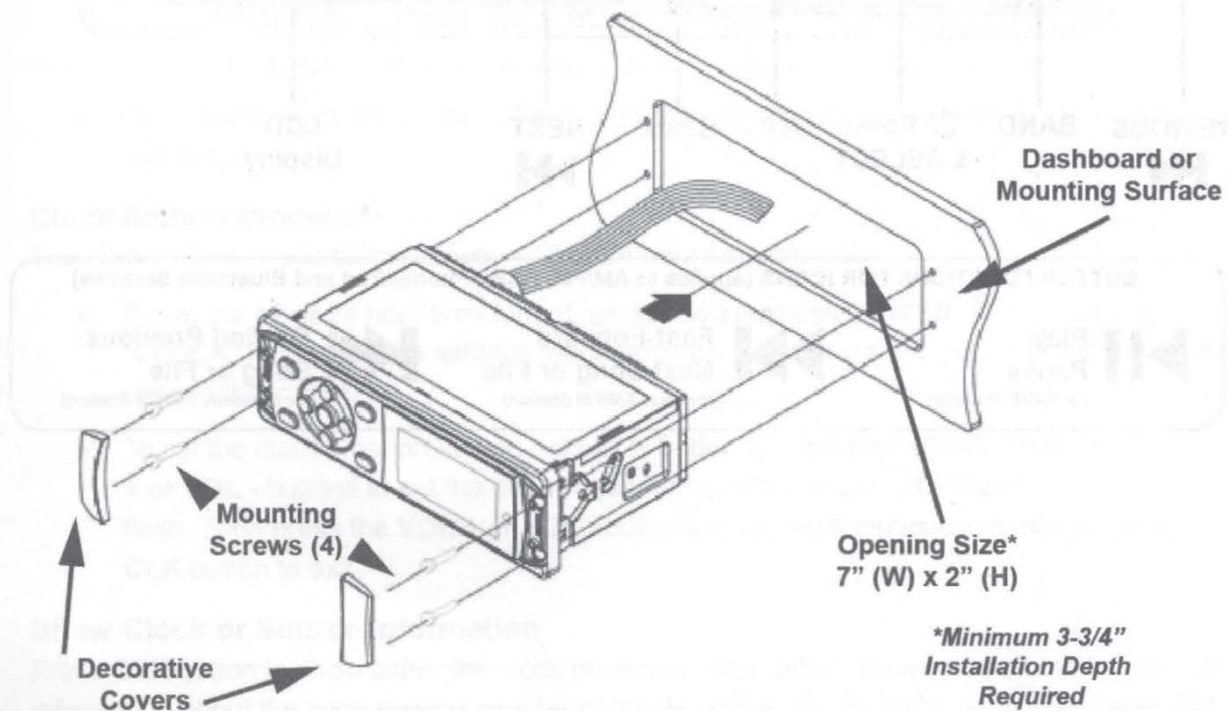

FRONT PANEL CONTROLS

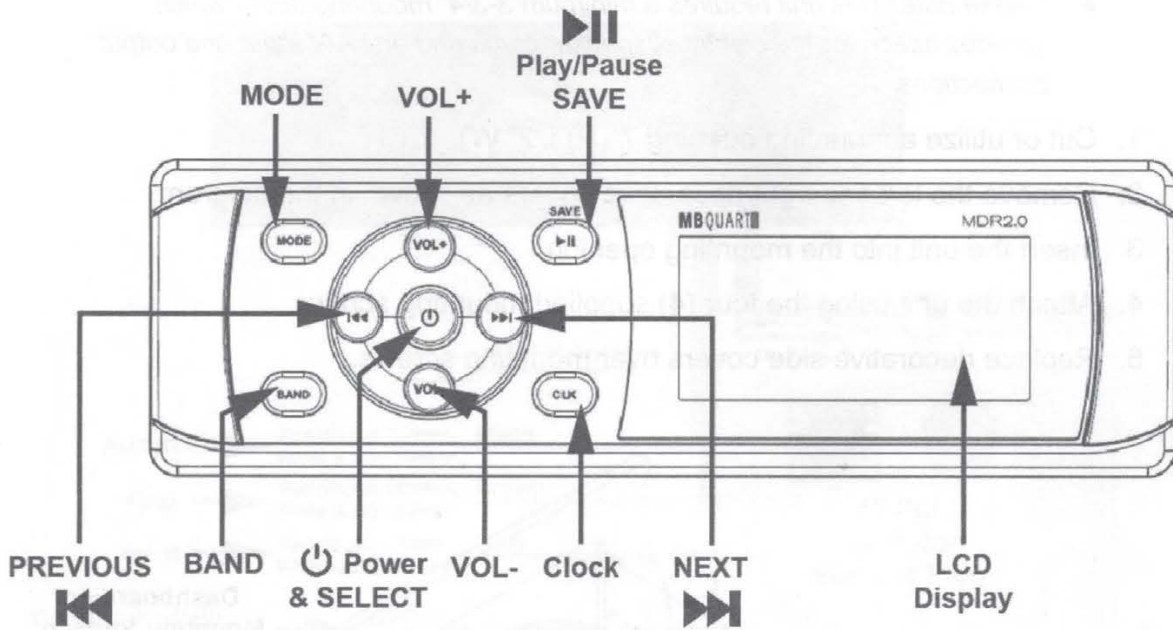



BUTTON FUNCTIONS FOR ICONS (applies to AM/FM, USB, iPhone/iPod and Bluetooth Sources)

▶|| Play
Pause
(or SAVE Presets)

▶▶▶ Fast-Forward
Next Song or File
(or Next AM/FM Station)

◀◀◀ Rewind Previous
Song or File
(or Previous AM/FM Station)



FRONT PANEL FUNCTIONS (BY MODE)

KEYS	ACTION	RADIO	USB	AUX IN	BT MUSIC
	Short	Power ON /BAS/TRE/BAL/FAD/EQ/LOUD/BEEP /CLOCK(12/24)/P_VO L/CT(sync/indep) /AREA/DX/STEREO	Power ON /BAS/TRE/BAL/FAD/ EQ/LOUD/BEEP /CLOCK(12/24)/ P_VOL	Power ON /BAS/TRE/BAL/FAD/ EQ/LOUD/BEEP /CLOCK(12/24)/ P_VOL	Power ON /BAS/TRE/BAL/FAD/ EQ/LOUD/BEEP /CLOCK(12/24)/ P_VOL
	Long	Power OFF	Power OFF	Power OFF	Power OFF
MODE	Short	Change Source	Change Source	Change Source	Change Source
	Long	BT Off / Link	BT Off / Link	BT Off / Link	BT Off / Link
BAND	Short	AM/FM Band Change	File search	/	/
	Long	Auto Store	/	/	/
	Short	Preset Change	Play/Pause	/	Play/Pause
	Long	Manual Save Station	/	/	/
I<<	Short	Seek Down	Previous File	/	Previous File
	Long	Manual Turn Down	Fast Rewind	Software Version	/
>>I	Short	Seek Up	Next File	/	Next File
	Long	Manual Turn up	Fast Forward	Reset (5 seconds)	/
CLK	Short	Info or Clock	Info or Clock	Info or Clock	Info or Clock
	Long	Clock Setting	Clock Setting	Clock Setting	Clock Setting
VOL+	Short	Volume Up	Volume Up	Volume Up	Volume Up
	Long	Volume Up (Fast)	Volume Up (Fast)	Volume Up (Fast)	Volume Up (Fast)
VOL-	Short	Volume Down	Volume Down	Volume Down	Volume Down
	Long	Volume Down (Fast)	Volume Down (Fast)	Volume Down (Fast)	Volume Down (Fast)

OPERATION

POWER AND BASIC ADJUSTMENTS

Turn the Unit ON or OFF

Press **POWER**  button to turn the unit ON. When the unit is switched on, press and hold **POWER**  button for 2 seconds to switch the unit OFF. A "GOOD BYE" message is displayed to confirm power down.

Sound Adjustments

Press and release **POWER**  button, then repeat to choose sound settings in the following order: BASS-TRE-BAL-FADER-EQ-LOUD

- Bass – Choose from -7 to +7
- Treble – Choose from -7 to +7
- Balance – Choose Left or Right (up to 7 steps in either direction)
- Fader – Choose Front or Rear (up to 7 steps in either direction)
- EQ – If "OFF", pressing the **VOL +** or **VOL -** buttons allow you to choose from pre-programmed tone settings* :
 - Classical
 - Rock
 - Pop
 - Flat
 - Jazz
 - EQ OFF
 - **Note: If one of the EQ sound settings is chosen, manual Bass and Treble adjustments are disabled. Only "BAL" and the name of the EQ setting will show in the Sound Adjustment menu. To disable the EQ and allow manual Bass/Treble setting, simply scroll through the settings until "EQ OFF" is displayed.*
- LOUD – Press the **VOL +** or **VOL -** buttons cycle between ON or OFF**.
 - ***Note: Loudness gives a boost of low and high frequencies at low volumes, but can add more distortion at high volumes. We recommend leaving in the OFF position and using an EQ setting to achieve the sound profile that achieves the best low and high volume performance for your system.*
- Once the sound settings are chosen, the menu will automatically cancel after 5 seconds of inactivity.

Setting Adjustments (USB, iPhone/iPod, Bluetooth or AUX Sources)

Press and release **POWER**  button, then repeat after cycling the sound adjustments for the setting menus: BEEP ON/OFF-CLOCK 12/24 - P_VOL

- In each menu item, pressing the **VOL +** or **VOL -** buttons allow you to select the sub-settings.
- Once the settings are chosen, the menu will automatically cancel after 5 seconds of inactivity.

OPERATION

BASIC ADJUSTMENTS (Continued)

Setting Adjustments (AM/FM Source ONLY)

The AM/FM source adds additional settings to the adjustment menu. Press and release **POWER**  button, then repeat after cycling the sound adjustments for the setting menus: BEEP ON/OFF- CLOCK 12/24 - P_VOL – CT SYNC or CT INDEP – AREA USA or AREA EUR– DX or LOC – STEREO or MONO

- In each menu item, pressing the **VOL +** or **VOL -** buttons allow you to select the sub-settings. The additional AM/FM settings are:
 - CT SYNC or CT INDEP – allows the clock to synch with the radio station's RDS time feed (SYNC) or to be set independently (INDEP) by the user
 - AREA USA or AREA EUR – Selects the region: USA or Europe
 - DX or LOC – Selects distance (DX) or local (LOC) for optimized reception
 - STEREO or MONO – Selects a stereo or mono broadcast reception
- Once the settings are chosen, the menu will automatically cancel after 5 seconds of inactivity.

Clock Setting Procedure

The clock allows you to select between 12 or 24 hour time formats.

- To set the 12 or 24 hour time format, press/release/press **POWER**  button until the "CLOCK" function in the settings menu appears. Then press the **VOL +** or **VOL -** buttons to choose the format.
- To set the clock time, press and hold **CLK** button and the hours flash. Then press the **VOL +** or **VOL -** buttons to set the hour. Press and quickly release **CLK** button until the minutes flash. Then press the **VOL +** or **VOL -** buttons to set the minutes. Once complete, press **CLK** button to exit.

Show Clock or Source Information

Press **CLK** button to show either the clock or source information. Depending on the source, text information about the song playing may be available on the display (such as RDS-enabled FM stations, USB music files, iPhone/iPod music or Bluetooth streamed music).

Preset (P_VOL) Setting

This function allows the user to set the volume level at which the unit powers up again depending on what level was recorded when the unit was last turned off.

- To set the P_VOL threshold, advance to the "P_VOL" function in the settings menu and rotate the **VOLUME/SEL** knob to choose the volume setting.
- When the volume threshold at the time of unit turn off is **less** than P_VOL value, the next time turns on the unit the volume will be the same as last time turned off.
- When the volume threshold at the time of unit turn off is **greater** than P_VOL value, the next time turns on the unit the volume will default to the lower P_VOL preset threshold.

OPERATION

AM/FM RADIO



Receive a Radio Station

There are 3 FM station groups - FM1, FM2 and FM3. There are 2 AM station groups - AM1 and AM2.

- To select a radio station group, press the **MODE** button to select the radio mode. Next press **BAND** button to select desired group (FM1, FM2, FM3, AM1 or AM2).
- Press and quickly release the **▶▶/◀◀** button to tune by automatically seeking up or down to the next available radio station frequency.
- Press and hold the **▶▶/◀◀** button for manual tuning up or down to the desired frequency.

Manually Store and Recall Radio Station Presets

The unit offers 6 presets for each of the AM and FM station groups. There are a total of 18 FM presets and 12 AM presets.

- To store radio station presets, press and hold the **▶▶** (play/pause) button for 2 seconds. The display shows "SAVE CH1."
- If you wish to store that station preset in CH1, simply press the **POWER**  button to store in that location.
- If you wish to store that station preset in CH2-CH6, use the press the **VOL +** or **VOL -** buttons to choose the preset location. Then press the **POWER**  button to store in that location.
- To recall a given radio station preset, quickly press the **▶▶** (play/pause) button to scroll through the presets.

Auto-Store Stations

This is a useful method to populate available radio stations in a new area.

- Press and hold **BAND** button for 2 seconds to automatically store stations in memory locations 1 through 6 of band 1, 2 or (if FM) 3. Stations will store in the order of scanning and reception. Use the **▶▶** (play/pause) button to scroll presets.

OPERATION

USB, iPhone/iPod & AUX Sources

USB Sources

When an USB source such as a thumb drive or portable media player is inserted to the USB port on the front panel of the unit, it supports playback of MP3 and WMA files automatically.

- To select USB as the source if already connected, press/release/press the **MODE** button until the USB mode display appears.

Selecting USB Music Files

Selecting the files uses the icon-based buttons in the round center control.

- Press the **NEXT** ►► or **PREVIOUS** ◄◄ button to skip to next/previous file.
- Hold the **NEXT** ►► or **PREVIOUS** ◄◄ button to fast forward or fast reverse.

USB Play/Pause

To play or pause the USB song:

- Press the ►|| button to play/pause the file.

Search USB Songs

If you have a USB device set up with folders (such as by artist or playlist), the search function allows you to navigate the folders for MP3 and WMA music files in two ways; Directory Search and Numeric Search. With an MP3/WMA file playing:

- **DIR SEARCH** - To search by directory, Press the **BAND** button to show DIR SCH.
- Press the **VOL+/-** buttons to select the folder. Next, press the **POWER** ⏻ button to enter the folder. Next, press the **VOL+/-** buttons to select the file. Finally, press the **POWER** ⏻ button to confirm. If at any time you need to go back a step, press ◄◄ back to access the previous folder.
- **NUM SEARCH** - To search by directory, Press the **BAND** button to show DIR SCH. Press **BAND** button again to show NUM SRC. The display shows "NUM ****."
- Press the **VOL+/-** buttons to select the numeric values. Next, press the **POWER** ⏻ button confirm.

iPhone/iPod Operation

The MDR2.0 supports full iPhone/iPhone music control.

- Connect a compatible iPhone/iPod cable to the USB port on the back of the unit.
- Connect the cable to the iPhone or iPod. It will play the music automatically.
- The front panel operation from there is same as the USB instructions above.

AUX INPUT Operation

The MDR2.0 has an RCA auxiliary input on the back of the unit. If connecting to a portable device with a 3.5mm headphone jack, an RCA to 3.5mm adapter cable is required (not included)

- Press the **MODE** button to switch to AUX IN when an auxiliary audio signal input is desired.

OPERATION

BLUETOOTH SOURCES

Bluetooth Pairing

You must first pair a Bluetooth-enabled device to stream music to your unit.

- Select “search” or “discover” on the Bluetooth device while the unit is in the BT MUSIC mode. “MDR2.0” should appear in the list of available devices. Select “MDR2.0.”
- If a password is required, input “0000.”
- When successfully paired, BT MUSIC is displayed on LCD.
- If no Bluetooth device is paired, “UNPAIRED” will show in the LCD display.

Stream Bluetooth Audio

This unit supports Bluetooth music streaming using the Headset Profile (HSP). It also supports text readout from compatible BT streams.

- Using a Bluetooth-enabled device, press the **MODE** button to switch to BT MUSIC source. It will play a song from the BT device automatically as long as it's been selected in the music player on the device.
- Press the **▶||** button to play/pause the song. Press **▶▶/◀◀** button to select next/previous song.

Disconnect Bluetooth Device

This is useful for mobile phones where the user wishes to place or receive a call.

- When the Bluetooth device is paired with the unit. Press and hold the **MODE** button to disconnect the Bluetooth. “BT OFF” is displayed.

Reconnect Bluetooth Device

This is useful if a Bluetooth-enabled mobile phone user has completed a call and wishes to continue playing music via Bluetooth.

- Press and hold the **MODE** button again to connect the previously paired Bluetooth device. “LINKED” is displayed.

Unit Reset

When errors occur in display or functions (such buttons not responding or errors on the display), you can reset the unit to its initial status. Please note, all memory settings will be lost.

- In the AUX mode, press and hold the **NEXT ▶▶** button for 5 seconds to reset the unit.

SPECIFICATIONS

GENERAL

Power Supply Requirements: DC 12 Volts, Negative Ground
 Current Drain: 10 Ampere (max.)
 Maximum Output Power: 4 x 16 watts into 4 Ohms @ 14.4V DC
 Preamp Output Voltage: 4.0V (with AUX, USB, or AM/FM Source)

Chassis Dimensions 6-3/4" (W) x 2" (H) x 3-3/4" (D)
**Note: Installation depth requires 3-3/4" minimum*

Tone Controls

- Bass (at 100 Hz) : ±10 dB
- Treble (at 10 kHz) : ±10 dB

RADIO

	FM	AM
Frequency Coverage	87.5 to 108 MHz	520 to 1710 kHz
IF	10.7 MHz	450 KHz
Sensitivity	4µV(S/N=30dB)	36dBuV(S/N=20dB)
Stereo Separation	>25dB	N/A (AM is Mono)

TROUBLESHOOTING

Symptom	Cause	Solution
No power.	The car ignition switch is not on.	If the power supply is connected to the car accessory circuits, but the engine is not moving, switch the ignition key to "ACC".
	The fuse is blown.	Replace the fuse.
No sound.	Volume is in minimum	Adjust volume to a desired level.
	Wiring is not properly connected.	Check wiring connection.
The operation keys do not work.	The built-in microcomputer is not operating properly due to noise.	Press the reset button.
The radio does not work. The radio station automatic selection does not work.	The antenna cable is not connected.	Insert the antenna cable firmly.
	The signals are too weak.	Select a station manually.

FCC Notice

This equipment has been tested and found to comply with the limits for a Class B digital device, pursuant to part 15 of the FCC Rules. These limits are designed to provide reasonable protection against harmful interference in a mobile installation. This equipment generates, uses and can radiate radio frequency energy and, if not installed and used in accordance with the instructions, may cause harmful interference to radio communications. However, there is no guarantee that interference will not occur in a particular installation.

WARNING: Changes or modifications not expressly approved by the party responsible for compliance could void the user's authority to operate the equipment.

This equipment complied with FCC radiation exposure limits set forth for an uncontrolled environment. This equipment should be installed and operated with minimum distance 20cm between the radiator & your body.

WARRANTY

Maxxsonics USA Inc. warrants this product, to the original consumer purchaser, to be free from defects in material and workmanship for a period of one (1) year from the date of purchase. Maxxsonics USA Inc. will, at its discretion, repair or replace defective products during the warranty period. Components that prove to be defective in materials and workmanship under proper installation and use must be returned to the original authorized Maxxsonics USA Inc. retailer from where it was purchased. A photocopy of the original receipt must accompany the product being returned. The costs associated with removal, re-installation and freight are not the responsibility of Maxxsonics USA Inc. This warranty is limited to defective parts and specifically excludes any incidental or consequential damages connected therewith. To view the full warranty, please visit the website.

The Bluetooth® word mark and logos are registered trademarks owned by the Bluetooth SIG, Inc. and any use such marks by MB Quart is under license.

All product names, logos, and brands are property of their respective owners. All company, product and service names used in this literature are for identification purposes only. Use of these names, logos, and brands does not imply endorsement.

©2019 Maxxsonics USA, Inc.

MBQuart products are designed and engineered in the USA by



MAXXSONICS

www.maxxsonics.com