

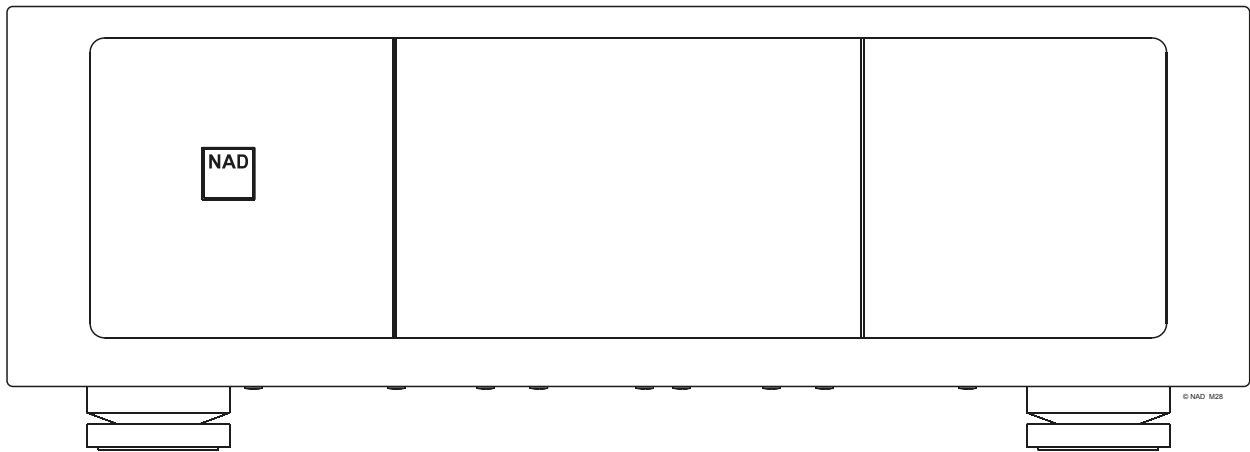

# M28

Seven Channel Power Amplifier

---



Owner's Manual

# IMPORTANT SAFETY INSTRUCTIONS

- **Read instructions** - All the safety and operating instructions should be read before the product is operated.
- **Retain instructions** - The safety and operating instructions should be retained for future reference.
- **Heed Warnings** - All warnings on the product and in the operating instructions should be adhered to.
- **Follow Instructions** - All operating and use instructions should be followed.
- **Cleaning** - Unplug this product from the wall outlet before cleaning. Do not use liquid cleaners or aerosol cleaners. Use a dry cloth for cleaning.
- **Attachments** - Do not use attachments not recommended by the product manufacturer as they may cause hazards.
- **Water and Moisture** - Do not use this product near water-for example, near a bath tub, wash bowl, kitchen sink, or laundry tub; in a wet basement; or near a swimming pool; and the like.
- **Accessories** - Do not place this product on an unstable cart, stand, tripod, bracket, or table. The product may fall, causing serious injury to a child or adult and serious damage to the product. Use only with a cart, stand, tripod, bracket, or table recommended by the manufacturer, or sold with the product. Any mounting of the product should follow the manufacturer's instructions, and should use a mounting accessory recommended by the manufacturer.
- **Cart** - A product and cart combination should be moved with care. Quick stops, excessive force, and uneven surfaces may cause the product and cart combination to overturn. 
- **Ventilation** - Slots and openings in the cabinet are provided for ventilation to ensure reliable operation of the product and to protect it from overheating. These openings must not be blocked or covered. The openings should never be blocked by placing the product on a bed, sofa, rug, or other similar surface. This product should not be placed in a built-in installation such as a bookcase or rack unless proper ventilation is provided or the manufacturer's instructions have been adhered to.
- **Power Sources** - This product should be operated only from the type of power source indicated on the marking label and connected to a MAINS socket outlet with a protective earthing connection. If you are not sure of the type of power supply to your home, consult your product dealer or local power company.
- **Power-Cord Protection** - Power-supply cords should be routed so that they are not likely to be walked on or pinched by items placed upon or against them, paying particular attention to cords at plugs, convenience receptacles, and the point where they exit from the product.
- **Mains Plug** - Where the mains plug or an appliance coupler is used as the disconnect device, the disconnect device shall remain readily operable.
- **Outdoor Antenna Grounding** - If an outside antenna or cable system is connected to the product, be sure the antenna or cable system is grounded so as to provide some protection against voltage surges and built-up static charges. Article 810 of the National Electrical Code, ANSI/NFPA 70, provides information with regard to proper grounding of the mast and supporting structure, grounding of the lead-in wire to an antenna discharge unit, size of grounding conductors, location of antenna discharge unit, connection to grounding electrodes, and requirements for the grounding electrode.
- **Lightning** - For added protection for this product during a lightning storm, or when it is left unattended and unused for long periods of time, unplug it from the wall outlet and disconnect the antenna or cable system. This will prevent damage to the product due to lightning and power-line surges.
- **Power Lines** - An outside antenna system should not be located in the vicinity of overhead power lines or other electric light or power circuits, or where it can fall into such power lines or circuits. When installing an outside antenna system, extreme care should be taken to keep from touching such power lines or circuits as contact with them might be fatal.
- **Overloading** - Do not overload wall outlets, extension cords, or integral convenience receptacles as this can result in a risk of fire or electric shock.
- **Flame Sources** - No naked flame sources, such as lighted candles, should be placed on the product.
- **Object and Liquid Entry** - Never push objects of any kind into this product through openings as they may touch dangerous voltage points or short-out parts that could result in a fire or electric shock. Never spill liquid of any kind on the product.
- **Headphones** - Excessive sound pressure from earphones and headphones can cause hearing loss.

- **Damage Requiring Service** - Unplug this product from the wall outlet and refer servicing to qualified service personnel under the following conditions:
  - When the power-supply cord or plug is damaged.
  - If liquid has been spilled, or objects have fallen into the product.
  - If the product has been exposed to rain or water.
  - If the product does not operate normally by following the operating instructions. Adjust only those controls that are covered by the operating instructions as an improper adjustment of other controls may result in damage and will often require extensive work by a qualified technician to restore the product to its normal operation.
  - If the product has been dropped or damaged in any way.
  - When the product exhibits a distinct change in performance-this indicates a need for service.
- **Replacement Parts** - When replacement parts are required, be sure the service technician has used replacement parts specified by the manufacturer or have the same characteristics as the original part. Unauthorized substitutions may result in fire, electric shock, or other hazards.
- **Battery Disposal** - When disposing of used batteries, please comply with governmental regulations or environmental public instruction's rules that apply in your country or area.
- **Safety Check** - Upon completion of any service or repairs to this product, ask the service technician to perform safety checks to determine that the product is in proper operating condition.

## WARNING



The lightning flash with arrowhead symbol, within an equilateral triangle, is intended to alert the user to the presence of uninsulated "dangerous voltage" within the product's enclosure that may be of sufficient magnitude to constitute a risk of electric shock to persons



The exclamation point within an equilateral triangle is intended to alert the user to the presence of important operating and maintenance (servicing) instructions in the literature accompanying the appliance.

## CAUTION REGARDING PLACEMENT



To maintain proper ventilation, be sure to leave a space around the unit (from the largest outer dimensions including projections) than is equal to, or greater than shown below.

- Left and Right Panels: 10 cm
- Rear Panel: 10 cm
- Top Panel: 10 cm

Do not install near any heat sources such as radiators, heat registers, stoves, or other apparatus (including amplifiers) that produce heat.

Do not defeat the safety purpose of the polarized or grounding - type plug. A polarized plug has two blades with one wider than the other. A grounding type plug has two blades and a third grounding prong. The wide blade or the third prong is provided for your safety. When the provided plug does not fit into your outlet, consult an electrician for replacement of the obsolete outlet.

The apparatus should only be used in moderate climates.

## FCC STATEMENT

This equipment has been tested and found to comply with the limits for Class B digital device, pursuant to Part 15 of the FCC Rules. These limits are designed to provide reasonable protection against harmful interference in a residential installation. This equipment generates, uses, and can radiate radio frequency energy and, if not installed and used in accordance with the instructions, may cause harmful interference to radio communications. However, there is no guarantee that interference will not occur in a particular installation. If this equipment does cause harmful interference to radio or television reception, which can be determined by turning the equipment off and on, the user is encouraged to try to correct the interference by one or more of the following measures:

- Reorient or relocate the receiving antenna.
- Increase the separation between the equipment and receiver.
- Connect the equipment into an outlet on a circuit different from that to which the receiver is connected.
- Consult the dealer or an experienced radio TV technician for help.

## CAUTION

- Changes or modifications to this equipment not expressly approved by NAD Electronics for compliance could void the user's authority to operate this equipment.
- To prevent electric shock, match wide blade of plug to wide slot, fully insert.
- Marking and rating plate can be found at the rear panel of the apparatus.
- To reduce the risk of fire or electric shock, do not expose this apparatus to rain or moisture. The apparatus shall not be exposed to dripping or splashing and that no objects filled with liquids, such as vases, shall be placed on apparatus.
- Mains plug is used as disconnect device and it should remain readily operable during intended use. In order to disconnect the apparatus from the mains completely, the mains plug should be disconnected from the mains socket outlet completely.
- An appliance with a protective earth terminal should be connected to a mains outlet with a protective earth connection.

## RESPONSIBLE PARTY

Lenbrook International  
633 Granite Court  
Pickering, ON L1W 3K1  
Canada  
Tel: 1 905 8316555

## IF IN DOUBT CONSULT A COMPETENT ELECTRICIAN.



This product is manufactured to comply with the radio interference requirements of EEC DIRECTIVE 2004/108/EC.

## NOTES ON ENVIRONMENTAL PROTECTION



At the end of its useful life, this product must not be disposed of with regular household waste but must be returned to a collection point for the recycling of electrical and electronic equipment. The symbol on the product, user's manual and packaging point this out.

The materials can be reused in accordance with their markings. Through re-use, recycling of raw materials, or other forms of recycling of old products, you are making an important contribution to the protection of our environment.

Your local administrative office can advise you of the responsible waste disposal point.

## INFORMATION ABOUT COLLECTION AND DISPOSAL OF WASTE BATTERIES (DIRECTIVE 2006/66/EC OF THE EUROPEAN PARLIAMENT AND THE COUNCIL OF EUROPEAN UNION) (FOR EUROPEAN CUSTOMERS ONLY)



Pb

Batteries bearing any of these symbols indicate that they should be treated as "separate collection" and not as municipal waste. It is encouraged that necessary measures are implemented to maximize the separate collection of waste batteries and to minimize the disposal of batteries as mixed municipal waste.

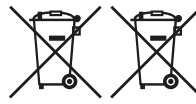

Hg

Cd

End-users are exhorted not to dispose waste batteries as unsorted municipal waste. In order to achieve a high level of recycling waste batteries, discard waste batteries separately and properly through an accessible collection

point in your vicinity. For more information about collection and recycling of waste batteries, please contact your local municipality, your waste disposal service or the point of sale where you purchased the items.

By ensuring compliance and conformance to proper disposal of waste batteries, potential hazardous effects on human health is prevented and the negative impact of batteries and waste batteries on the environment is minimized, thus contributing to the protection, preservation and quality improvement of the environment.

# INTRODUCTION

## GETTING STARTED

### WHAT'S IN THE BOX

Packed with your M28 you will find

- A detachable mains power cord
- Four pieces of magnetic feet
- Cleaning cloth
- Quick Setup Guide

### QUICK SETUP GUIDE

In case you simply cannot wait to experience the performance of your new NAD M28 Seven Channel Power Amplifier, the following QUICK SETUP GUIDE is recommended to help you get started.

Ensure that the M28 is unplugged before making any connections. It is also advisable to power-down or unplug all associated components while making or breaking any signal or AC power connections.

- 1 Set the external source's volume control to minimum level. External source can be a preamplifier, processor, amplifier or any applicable device.
- 2 Set SELECT switch to BALANCED or SINGLE-ENDED. Connect the analog audio output of your external source to the M28 rear panel's BALANCED or SINGLE-ENDED analog audio input. Depending upon the source's configuration, analog audio input connection can be made up to seven channels either via BALANCED or SINGLE-ENDED input ports.
- 3 Connect your speakers to the SPEAKER terminals of M28. Note suggested speaker connections as reflected in the rear panel channel allocations.
- 4 Plug-in to a mains power source the M28's supplied mains power cord. Connect corresponding end of the mains power cord to the AC mains input of M28 and the plug connected to a mains power source.
- 5 Plug-in also to a mains power source the external source's mains power cord. Power up the external source ahead of the M28.
- 6 Set to ON the rear panel POWER switch of M28. The M28 goes to standby mode as shown by the amber status condition of the Power indicator.
- 7 Press **⏻** (Standby) button for the M28 to be switched ON from standby mode. The Power indicator will turn from amber to bright/white color. The M28 is ready for operation.
- 8 Adjust the external source's volume control according to desired listening level.

### SAVE THE PACKAGING

Please save the box and all of the packaging in which your M28 arrived. Should you move or otherwise need to transport your M28, this is by far the safest container in which to do so. We've seen too many otherwise perfect components damaged in transit for lack of a proper shipping carton, so please: Save that box!

### NOTES ON INSTALLATION

- Your NAD M28 should be placed on a firm, level surface.
- Avoid placing the unit in direct sunlight or near sources of heat and damp.
- Allow adequate ventilation.
- Do not place the unit on a soft surface like a carpet.
- Avoid placing the M28 inside a closed cabinet that is not well ventilated as this may compromise the M28's performance and reliability.
- Ensure that the M28 is unplugged before making any connections.
- For best performance, use quality speaker leads of 16 gauge (1.5mm<sup>2</sup>) thickness or more.
- If the unit is not going to be used for some time, disconnect the plug from the mains power source.
- Use a dry cloth for cleaning.

### DO NOT REMOVE THE COVER; THERE ARE NO USER-SERVICEABLE PARTS INSIDE.

### BARE WIRES AND PIN CONNECTORS



**WARNING:** The terminals marked with this symbol are hazardous live. External wiring connected to these terminals requires installation by an instructed person or the use of ready-made leads or cords.

Bare wires and pin sockets should be inserted into the hole in the shaft of the terminal. Unscrew the speaker terminal's plastic bushing until the hole in the screw shaft is revealed. Insert the pin or bare cable end into the hole and secure the cable by tightening down the terminal's bushing. Ensure bare wire from the speaker cables does not touch the back panel or another socket. Ensure that there is only 1/2" (1 cm) of bare cable or pin and no loose strands of speakers wire.

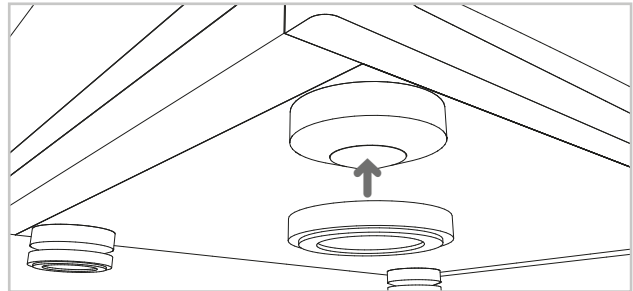

### FEET INSTALLATION

The supplied magnetic feet can be easily installed by aligning and attaching them to their corresponding foot shoe. Refer to illustration below.

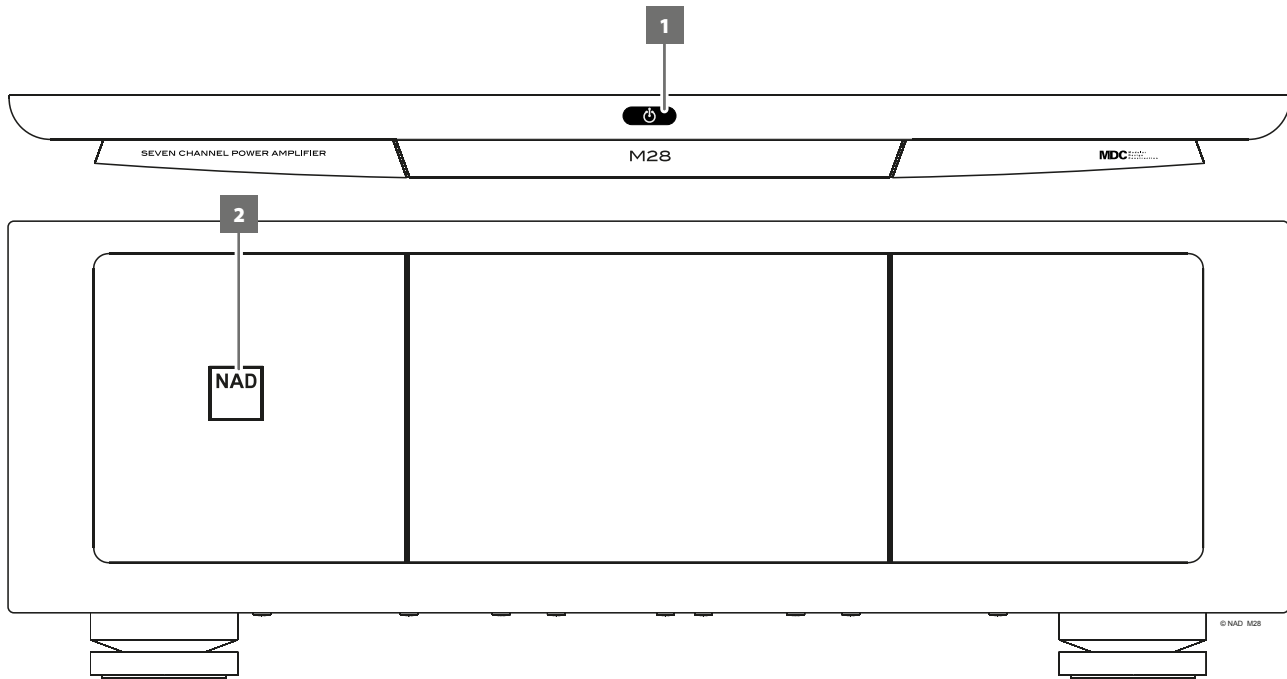



### 1 (STANDBY)

- Press  (Standby) button for the M28 to be switched ON from standby mode. The Power indicator will turn from amber to bright/white color.
- Press and hold  (Standby) button until M28 switches back to standby mode. The Power indicator will illuminate to amber color at standby mode.
- The  (Standby) button cannot activate the M28 with the rear panel POWER switched off.

### 2 POWER INDICATOR (NAD LOGO)

- The NAD logo in the front panel also serves as a Power indicator.
- Power indicator colors  
Bright/white - Normal operating mode  
Amber - Standby mode  
Red - Protect mode

### IMPORTANT NOTE

*For the  (Standby) button to activate, two conditions must be completed.*

- *Plug-in the supplied mains power cord to a mains power source. Connect corresponding end of the mains power cord to the AC mains input of M28 and the plug connected to a mains power source.*
- *The rear panel POWER switch must be set to ON position.*

### AUTO STANDBY

The M28 can be setup to automatically go to standby mode if there is no active source input within 30 minutes. Auto standby mode can be enabled or disabled by the following steps.

#### Enable Auto Standby mode

- With M28 at operating mode, press and hold the LED LEVEL button until the Power indicator (NAD logo) flashes once.
- At operating mode, the M28 will automatically go to standby mode if there is no active source input within 30 minutes.

#### Disable Auto Standby mode

- With M28 at operating mode, press and hold the LED LEVEL button until the Power indicator (NAD logo) flashes twice.
- At operating mode, M28 will not automatically go to standby mode even if there is no active source input within 30 minutes. Press  to switch M28 from operating mode to standby mode.

# IDENTIFICATION OF CONTROLS

## REAR PANEL

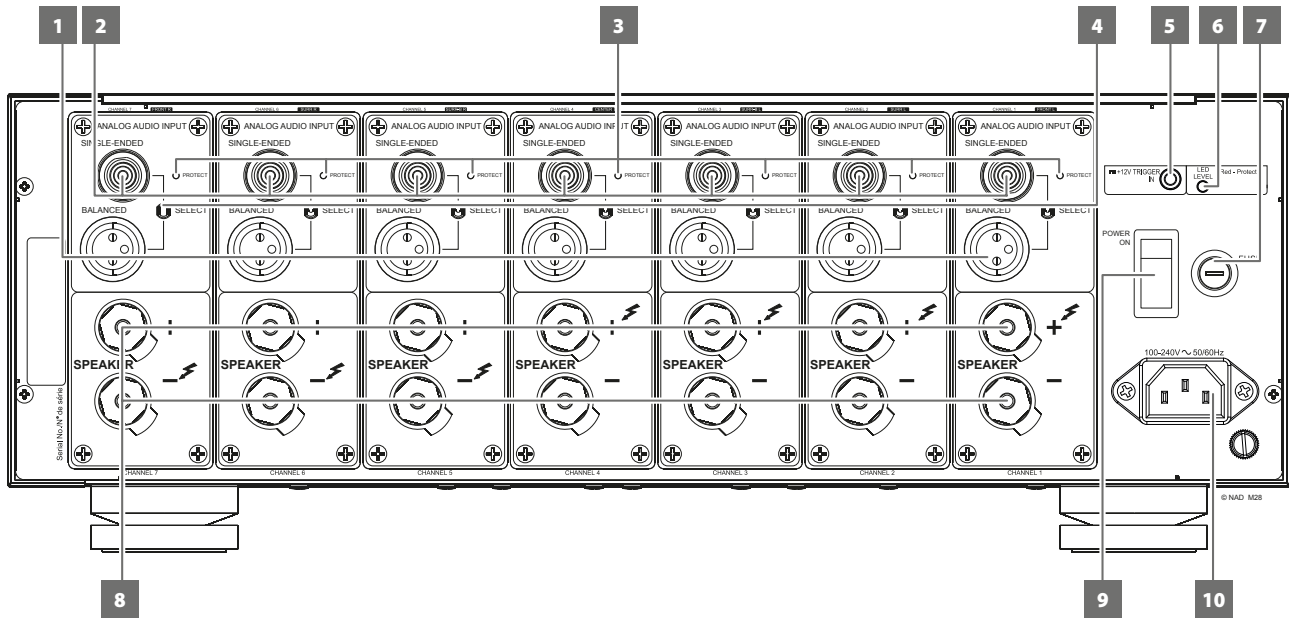

### ATTENTION!

Ensure that the M28 is unplugged before making any connections. It is also advisable to power-down or unplug all associated components while making or breaking any signal or AC power connections.

#### 1 BALANCED

- Use the BALANCED analog audio input of the M28 if the external source to be connected has BALANCED audio output. Superior audio quality is ensured with the distinctive noise reduction capability of BALANCED connection with XLR jacks.
- With BALANCED as the selected audio input, ensure that SELECT switch is set to BALANCED.
- For optimum heat dissipation in an AV surround system, the following audio channel allocations are recommended:  
 Channel 1 = Front Left speaker  
 Channel 2 = Surround Left speaker  
 Channel 3 = Surround Back Left speaker  
 Channel 4 = Center speaker  
 Channel 5 = Surround Back Right speaker  
 Channel 6 = Surround Right speaker  
 Channel 7 = Front Right speaker

#### PIN CONFIGURATION OF BALANCED XLR JACK

- Pin 1: Ground
- Pin 2: Positive (signal live)
- Pin 3: Negative (signal return)

#### 2 SINGLE-ENDED

- Use single-ended analog audio input for sources (preamplifiers or processors) that are not equipped with BALANCED analog audio output.
- With SINGLE-ENDED as the selected audio input, ensure that SELECT switch is set to SINGLE-ENDED.

#### 3 PROTECT

- When a specific channel goes to protect mode, the corresponding PROTECT LED will turn red. The other amplifiers that did not go to protect mode will continue to function as indicated by their respective PROTECT LEDs illuminated in green.

#### PROTECT LED INDICATOR COLORS

CONDITION	PROTECT LED COLOR	POWER INDICATOR (NAD LOGO) COLOR
Normal operation	Green	Bright/white
Overheat	Red (per applicable channels; other channels may remain green)	Bright/white
Short circuit	No light (all channels)	Red

#### IMPORTANT NOTES

- Always turn OFF the M28 and other components in the system before connecting or disconnecting anything to the BALANCED audio input jacks.
- Before switching ON the M28 from standby mode for the first time, make sure that the volume control of the external source is set to minimum level position. This prevents inadvertently beginning a session at excessive volume.
- Depending upon the source's configuration, analog audio input connection can be made up to seven channels either via BALANCED or SINGLE-ENDED input ports.

### PROTECT MODE

If one or more PROTECT LEDs turn red or become all extinguished, this indicates that the protection circuitry of the M28 had been engaged. Immediately press the Standby button, turn off Power switch and then unplug the mains power cord from the mains power source. Undertake the following

- Check if all speaker wires are connected correctly and that none of the wires are damaged, causing a short circuit.
- Another cause may be excessive heat build-up inside the amplifier. Make sure there is adequate ventilation around the amplifier and that none of its ventilation slots, top or bottom are blocked. After the amplifier has cooled down, it will function normally again.
- In case one or more of the PROTECT LEDs or Power indicator remained illuminated in red despite the checks mentioned above, immediately press the Standby button, turn off Power switch and then unplug the mains power cord from the mains power source. Have the unit inspected by a qualified service technician before attempting to use it again.

### 4 SELECT

- Use this switch to select the type of analog audio input.
- SELECT switch settings  
Upper position – SINGLE-ENDED input is selected.  
Lower position – BALANCED input is selected.

### WARNING!

*Do not adjust the SELECT switch while the M28 is at operating mode. Use SELECT switch to choose BALANCED or SINGLE-ENDED only when the M28 is at standby mode or powered down.*

### 5 +12V TRIGGER IN

- The +12V Trigger input allows the M28 to be switched remotely from standby mode to ON and vice-versa by an ancillary equipment such as a preamplifier, AV processor, etc. The controlling device must be equipped with a 12V trigger output to use this feature.

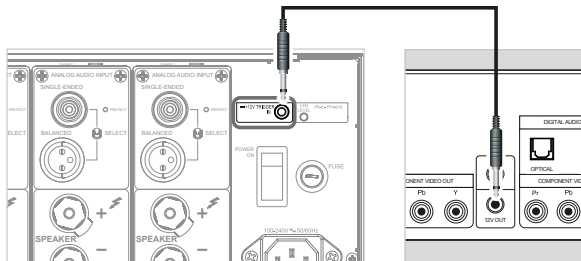

### WARNING

*The front panel (Standby) button is disabled as long as the male plug of the mono cable (with or without +12V DC) is connected to M28's +12V TRIGGER IN. Unplug the mono cable for the M28 to be normally switched ON (or back to standby mode) using the front panel (Standby) button.*

### 6 LED LEVEL (DIMMER)

- Toggle to reduce or restore Power indicator brightness or completely turn it off.

### 7 FUSE HOLDER

- In the unlikely event a fuse needs to be replaced, unplug the mains power cord from the wall. Then, remove all connections from the amplifier. Use a flathead screw driver or similar to open the fuse holder via the slot indicated. With the screw driver in place, push and turn counterclockwise to open the fuse holder.
- Only replace the fuse with the same type, size, and specification.

### IMPORTANT NOTICE

*Do not use any substitute fuses of different types or with different ratings or values. Failure to observe this precaution may cause damage to the amplifier circuits and may create a fire hazard and/or defeat the safety built into the amplifier and may void the warranty.*

### 8 SPEAKER

- The M28 is equipped with gold-plated, color-coded, transparent and special high-current binding-post speaker terminals.
- Connect FRONT L, FRONT R, CENTER, SURR R, SURR L, SURR-BL and SURR-BR speaker terminals to corresponding speakers. Make sure the "+" (red) terminal and "-" (black) terminal are connected to the corresponding "+" and "-" terminals of the speaker. Use extra care to ensure that no stray wires or strands cross between posts or terminals at either end.
- The M28 is designed to produce optimum sound quality when connected to speakers with impedances within its operating range. Please make sure that all the speakers are rated 4 ohms minimum per speaker.

### NOTE

*Use stranded wire of at least 16 gauge (AWG). Connections to the M28 can be made with banana plugs or by using bare wire or pins. Use the transverse hole through the post for bare-wire or pin connections. By loosening the terminal's plastic nut, make a clean, neat connection and re-tighten carefully. To minimize the danger of short-circuit, ensure that only 1/2-inch of exposed wire or pin is employed when connecting.*

### 9 POWER

- Supply the AC mains power to the M28.
- When the POWER switch is set to ON position, the M28 goes to standby mode as shown by the amber status condition of the Power indicator. Press (Standby) button to switch ON the M28 from standby mode.
- If you intend not to use the M28 for long periods of time (such as when on vacation), switch off the POWER switch.
- The (Standby) button cannot activate the M28 with the rear panel POWER switched off.

### 10 AC MAINS INPUT

- The M28 comes supplied with two types of detachable mains power cord. Select applicable type for your usage. Connect corresponding end of the mains power cord to the AC mains input of M28 and the plug connected to a mains power source.
- Always disconnect the mains power plug from the mains power source first, before disconnecting the cable from the M28's AC Mains input socket

# REFERENCE

## TROUBLESHOOTING

CONDITION	POSSIBLE CAUSES	POSSIBLE SOLUTIONS
<b>No power.</b>	• Mains power cord unplugged from mains power source or from M28's AC mains input.	• Connect the mains power cord to M28's AC mains input and then plug into a mains power source.
	• Power switch is off.	• Switch ON the Power switch.
	• M28 at standby mode.	• Press <b>⏻</b> (Standby) button to switch ON the M28 from standby mode.
<b>M28 always at standby mode; cannot be switched ON using the <b>⏻</b> (Standby) button.</b>	• A mono plug is plugged-in at the +12V TRIGGER IN port of the rear panel.	• Unplug the mono plug.
<b>No sound.</b>	• No input signal applied through the analog audio input ports.	• Check that there is active input signal applied through the analog audio input ports.
	• External source volume control is set to minimum level.	• Turn up external source's volume control until audio is heard.
<b>No sound one channel.</b>	• Speaker not properly connected or damaged.	• Check connections and speakers.
	• Input lead disconnected or damaged.	• Check leads and connections.
<b>There is no BALANCED audio output.</b>	• SELECT switch is set to SINGLE-ENDED.	• Set SELECT switch to BALANCED.
<b>There is no SINGLE-ENDED audio output.</b>	• SELECT switch is set to BALANCED.	• Set SELECT switch to SINGLE-ENDED.



All specs are measured according to IHF 202 CEA 490-AR-2008 standard. THD is measured using AP AUX 0025 passive filter and AES 17 active filter.

**OVERALL SPECIFICATION**

FTC power, two channels	≥ 220 W (ref. rated THD, 8 ohms, 1kHz, two channels driven)
	≥ 400 W (ref. rated THD, 4 ohms, 1kHz, two channels driven)
Rated power, all channels	≥ 200 W (ref. rated THD, 8 ohms, 20 Hz - 20 kHz, all channels driven)
	≥ 340 W (ref. rated THD, 4 ohms, 20 Hz - 20 kHz, all channels driven)
Rated THD (CCIF IMD, DIM 100)	≤ 0.003 % (ref. 20 Hz - 20 kHz, 250 mW to rated power)
	≤ 0.0005 % (ref. 20 Hz - 20 kHz, 1/2 rated power)
IHF dynamic power	280 W (8 ohms, all channels driven)
	560 W (4 ohms, 2 channel driven)
	500 W (2 ohms, 2 channel driven)
Damping factor	> 750 (ref. 8 ohms, 50 Hz and 1 kHz)
Input sensitivity	1.3 V (ref. rated power)
Input impedance	47 kohms (Balanced)
	23 kohms (Single-ended)
Signal/noise ratio	> 102dB (A-weighted ref. 1W, Balanced)
	> 97 dB (A-weighted ref. 1W, Single-ended)
	> 124 dB (A-weighted ref. rated power, Balanced)
	> 120 dB (A-weighted ref. rated power, Single-ended)
Frequency response	± 0.1 dB (ref. 20 Hz - 20 kHz)
	- 3 dB at 3 Hz to 60 kHz
Voltage gain	29.5 dB ±0.3 dB
Time to go to Standby mode at no input signal	≤ 30 minutes
Standby power	≤ 0.5W

**DIMENSION AND WEIGHT**

Gross dimension (W x H x D)*	435 x 156 x 380 mm
	17 7/8 x 6 3/16 x 15 inches
Shipping weight	21.2 kg (46.7 lbs)

\* - Gross dimension includes extended rear panel terminals and installed feet

Specifications are subject to change without notice. Check out [www.NADelectronics.com](http://www.NADelectronics.com) for updated documentation or latest information about M28.



[www.NADelectronics.com](http://www.NADelectronics.com)

**©2020 NAD ELECTRONICS INTERNATIONAL  
A DIVISION OF LENBROOK INDUSTRIES LIMITED**

All rights reserved. NAD and the NAD logo are trademarks of NAD Electronics International, a division of Lenbrook Industries Limited.  
No part of this publication may be reproduced, stored or transmitted in any form without the written permission of NAD Electronics International.  
While every effort has been made to ensure the contents are accurate at the time of publication, features and specifications may be subject to change without prior notice.

M28-OM-EN-V04 - JUL 2020

# NAD M28 Seven Channel Power Amplifier Quick Setup Guide

1

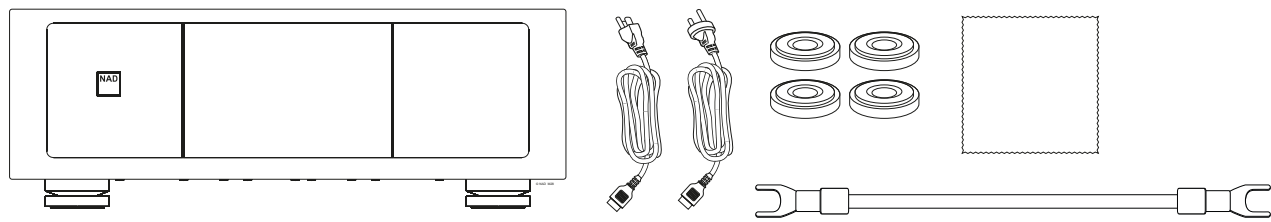

[nadelectronics.com/product/m28-seven-channel-power-amplifier](http://nadelectronics.com/product/m28-seven-channel-power-amplifier)  
[support.nadelectronics.com](mailto:support.nadelectronics.com)



2

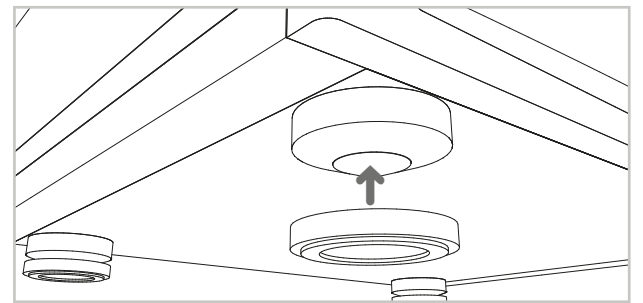

## M28 CONNECTION WITH M17/M17V2/M17V2i AND OTHER DEVICES (APPLICABLE TO 230V/EUROPEAN VERSION UNITS ONLY)

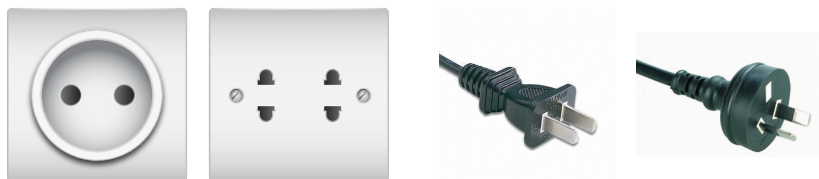

If your electrical outlet or AC plug has no earth connection like the examples shown to the left, it is **NECESSARY** that the ground terminals of the following products are connected together using the supplied grounding cable as illustrated below.



### IMPORTANT!

- Ensure that the units are handled carefully to avoid scratches or dents. Use protective cushions or pads to lay down the units when turning them over.
- If M28 is paired with other products, ensure that the supplied grounding cable is connected to M28's ground terminal and the other product's corresponding ground terminal (it may be marked ⊕); consult with your other product's service department for guidance in locating its ground connection).

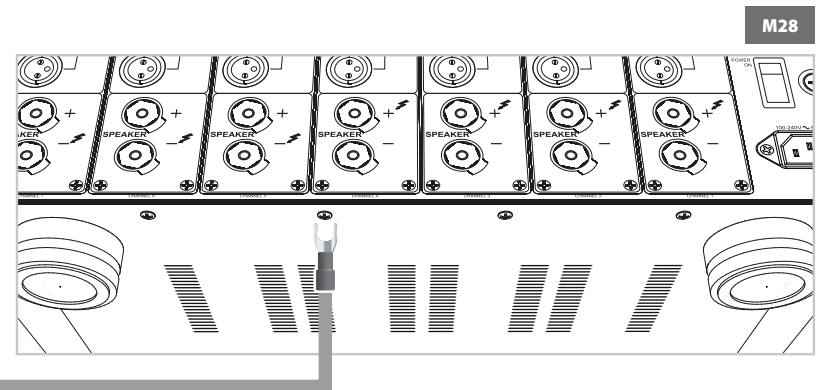
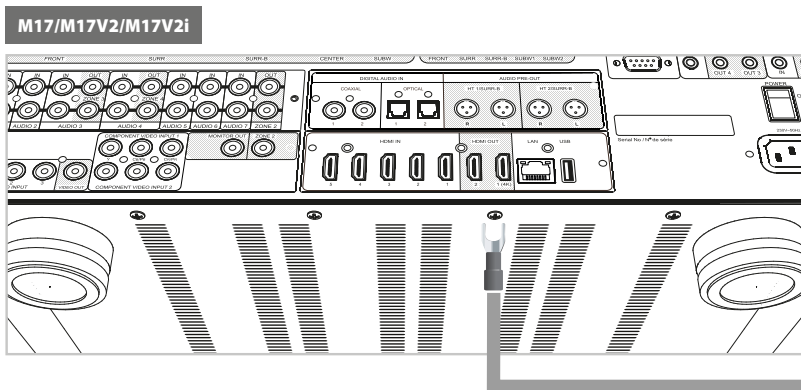

3A

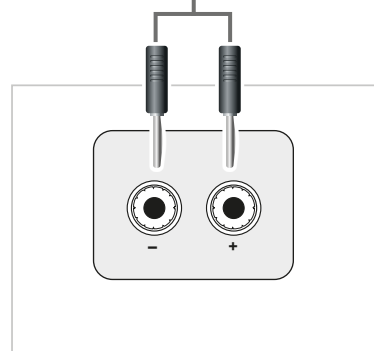
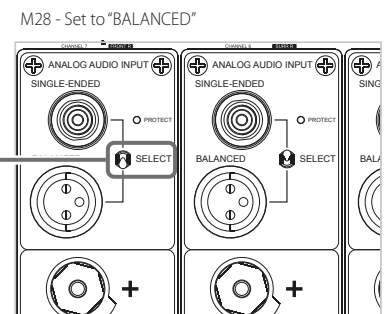
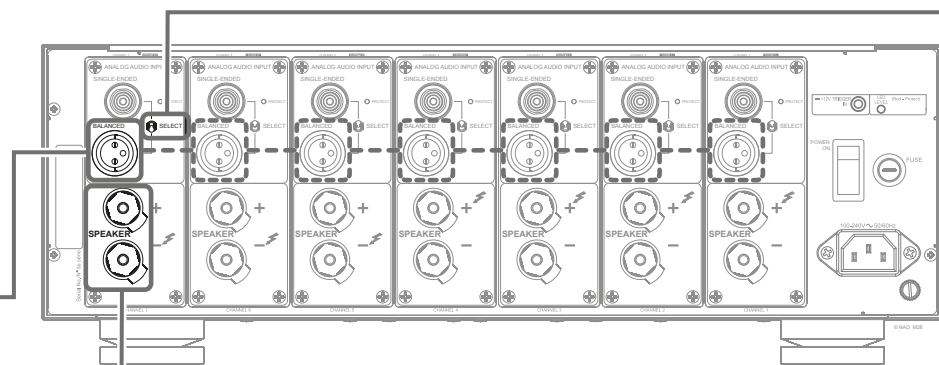
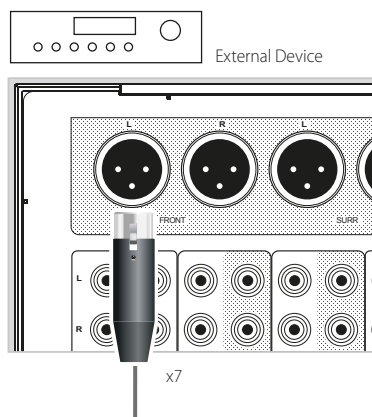

2 Speakers / 5 Speakers / 7 Speakers

