

SONOS[®] | **SONANCE**[®]

INSTALLATION MANUAL

SONOS IN-WALL
BY SONANCE

Introduction

Thank you for purchasing SONOS IN-WALL by SONANCE Speakers. When properly installed your new speakers will give you years of entertainment pleasure.

Box Contents

- (2) SONOS In-Wall Speakers
- (2) Paintable Grilles
- (2) Mounting Cut-out Templates

WARNING: THESE SPEAKERS HAVE FASTMOUNT TABS THAT PREVENT THE SPEAKER FROM FALLING OUT OF THE MOUNTING HOLE DURING THE INSTALLATION PROCESS. THE EDGES OF THE FASTMOUNT TABS ARE VERY SHARP. USE CAUTION WHEN HANDLING THE SPEAKER.

Home Theater Speaker Placement

Surround Speakers - 5.1-Channel System

Locate the surround channel speakers on the side walls 2 - 6 feet (0.6 - 1.8m) behind the listening position, 5 - 7 feet (1.5 - 2.1m) from the floor (see Figure 1).

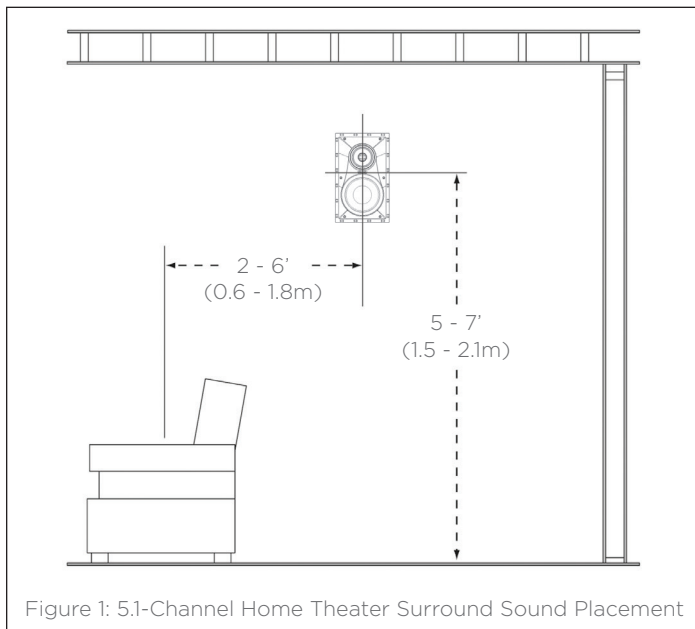

Figure 1: 5.1-Channel Home Theater Surround Sound Placement

Surround Speakers - 7.1-Channel System

- Left & right surround speakers: Place the left and right surround speakers directly to the sides of the listening position, 5 - 7 feet (1.5 - 2.1m) from the floor.
- Surround back speakers: Place the surround back speakers in the rear wall, 3 - 6 feet (0.9 - 1.8m) apart and at 5 - 7 feet (1.5 - 2.1m) from the floor (see Figure 2).

Stereo Speaker Placement

2-Channel System

- Place the left and right speakers 6 - 10 feet (1.8 - 3m) apart, with the main listening position as close to midway between the speakers as possible.
- The speakers should be at least 2 feet (0.6m) away from the side walls.
- The main listening position should be 4 - 10 feet (1.2 - 3m) away from the speakers.

- In most cases pivoting the midrange/tweeter of each speaker directly towards the main listening position will help maximize the stereo soundstage.

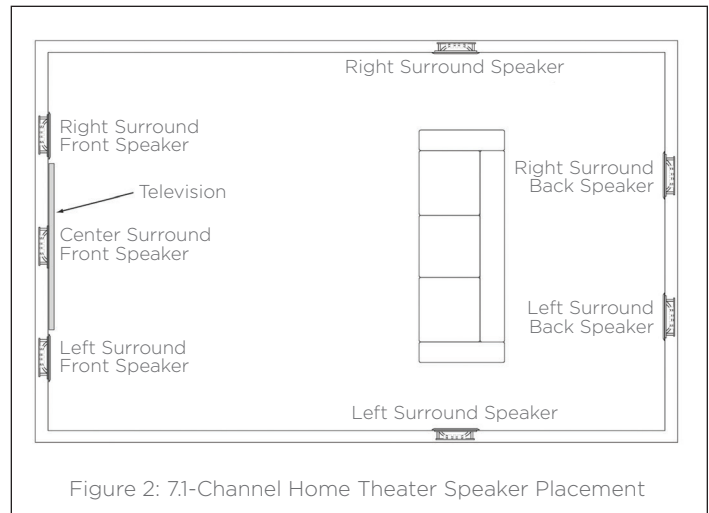

Figure 2: 7.1-Channel Home Theater Speaker Placement

Before Installation: Retrofit

1. Determine the location for the speaker (see Figures 1 and 2).
2. Perform an obstruction survey using a stud finder to be certain that there are no studs, conduit, pipes, heating ducts, pocket doors or air returns in the wall cavity that will interfere with the speaker. If you are unsure about obstructions, drill a small hole in the center of the outline and insert a coat hanger wire into the hole to feel around for possible obstructions.
3. Cut the mounting hole using a keyhole or drywall saw, and run the speaker wires from the mounting hole to the amplifier location.

NOTE: CONSULT LOCAL BUILDING CODES BEFORE RUNNING SPEAKER WIRES THROUGH WALLS.

Installation

SONOS IN-WALL by SONANCE speakers feature an integral Roto-Lock® mounting system for quick mounting directly into existing walls.

1. Strip 1/4 - 1/2" (6 - 12mm) of insulation from each speaker lead. Twist the strands or tin the exposed wire with solder to ensure that there are no stray strands.

NOTE: STRAY STRANDS THAT TOUCH EACH OTHER CAN CAUSE A SHORT-CIRCUIT THAT CAN DAMAGE THE AMPLIFIER.

2. The speaker's terminals are spring-loaded. Push the top of each terminal down to open the connector and insert the exposed wires into the holes in the spring terminals. The speaker's positive spring terminal is labeled with a red dot; the negative spring terminal is labeled with a black dot. Double-check that you connected amplifier "+" to speaker "+" and amplifier "-" to speaker "-".
3. Make sure all the Roto-Lock toggle feet are retracted so that they are tucked within the mounting hole's border. Insert the speaker into the hole in the wall (see Figure 3). The Roto-Lock system can accommodate a wall material thickness of 1-1/4" (32mm) with the toggle foot cap removed the system can accommodate a wall material thickness of 1-7/8" (48mm).

Figure 3: Inserting the Speaker into the Mounting Hole

Roto-Lock Clamps (retracted)

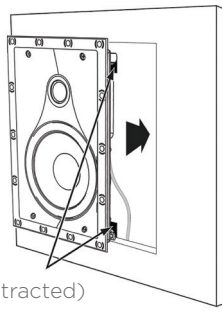

4. When installing into double drywall or other thicker wall materials, you may need to remove part of the two-piece toggle feet. Use a small screwdriver to gently release the two locking levers (see Figure 4).

Locking Levers

Remove Cap

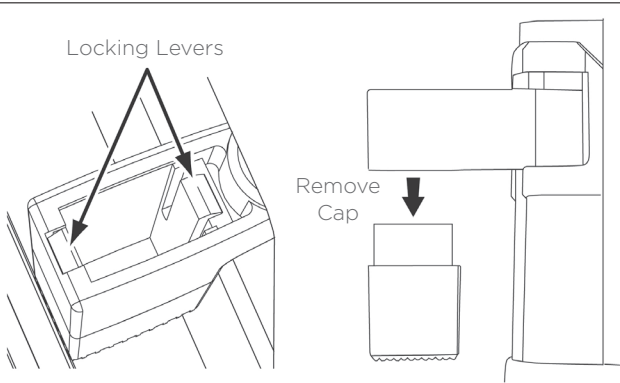

Figure 4: Removing the Caps from the Roto-Lock Toggle Feet

5. Tighten the screws on the front of the speaker baffle. The Roto-Lock toggle feet will automatically rotate into position and begin clamping the speaker (see Figure 5).

- When you notice resistance on the screws the speaker has been clamped successfully.
- There are four toggle feet on each speaker.

Roto-Lock Screws

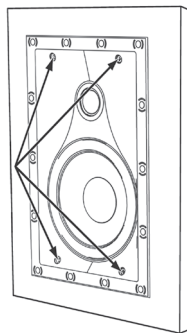

Figure 5: Tightening the Roto-Lock Screws

IMPORTANT: ALWAYS USE LOW-TORQUE SETTINGS; NEVER OVERTIGHTEN.

NOTE: ADJUSTING THE TENSION OF THE ROTO-LOCK CLAMPS SO THAT THE SPEAKER FRAME IS FLAT WILL HELP ENSURE THAT THE GRILLE CONTACTS THE WALL ALL THE WAY AROUND THE SPEAKER FOR A PROPER FIT.

6. The micro-trim grille is held in place by several small, powerful magnets on the speaker frame. Place the grille against the speaker and the magnets will hold it firmly in place.

When properly installed, the grille trim should make contact with the wall all the way around the speaker.

Speaker Adjustments

Pivoting Midrange/Tweeter Assembly

All SONOS IN-WALL by SONANCE Speakers have a pivoting tweeter. If you're using the speakers as surround channel speakers in a home theater, pivot the drivers towards a wall or window, away from the listeners.

To pivot the midrange/ tweeter assembly, apply light pressure to the ring around the outside edge of the midrange cone, as shown in figure 6. Take care not to touch or apply pressure to the midrange cone itself.

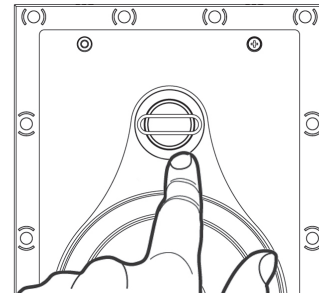

Figure 6: Pivoting the Midrange/Tweeter Assembly

To pivot the tweeter, apply light pressure to the ring around the outside edge of the tweeter, as shown in figure 7. Make sure not to touch or apply pressure to the tweeter itself.

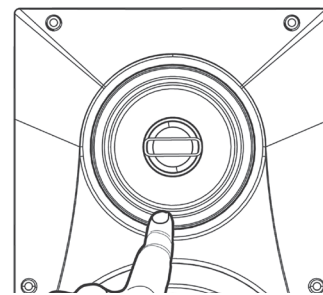

Figure 7: Pivoting the Tweeter

Unlocking SONOS Audio Enhancements

SONOS IN-WALL by SONANCE speakers include exclusive audio enhancements when used with a SONOS Amp. Use the free SONOS app to unlock them.

Audio enhancements include:

- Custom EQ settings
- Gain adjustment
- Dynamic bass extension
- Signal limiting/loudspeaker protection

1. Download the SONOS mobile app from the app store on a mobile device.
2. Open the app and follow the prompts to set up your SONOS system.
3. After Amp is set up, go to Settings>System and choose the room your speakers are in.
4. Choose Detect Sonos Architectural to unlock the audio enhancements.

Grille Painting Instructions

Before You Begin

SONOS by Sonance In-Wall and In-Ceiling speaker grilles completely cover the exposed speaker frame, so only the grilles (not the speakers themselves) require painting.

IMPORTANT: IF THE WALL OR CEILING WILL BE PAINTED AFTER THE SPEAKERS ARE INSTALLED, THE SPEAKER FLANGE AND BAFFLE MUST BE MASKED BEFORE PAINTING THE WALL OR CEILING.

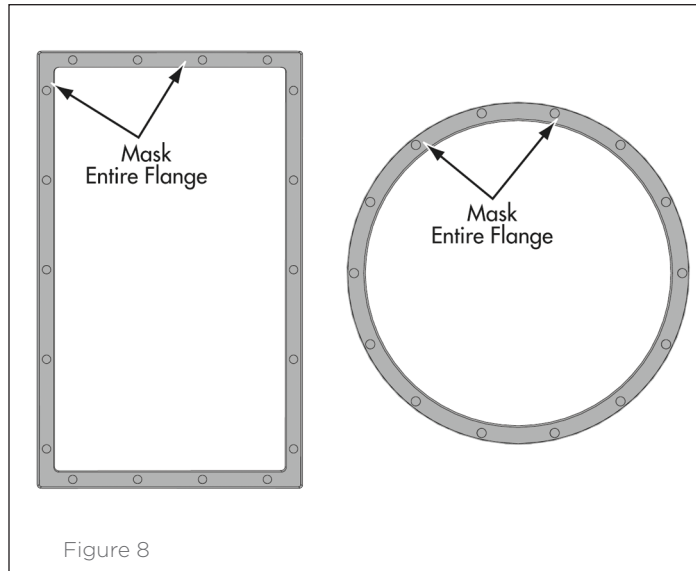

Figure 8

Preparing The Grille For Painting

Carefully remove the scrim cloth from the underside of the grille. The scrim cloth is held in place with a light tacking glue. Use a heating agent such as a heat gun or hair dryer to soften the glue and carefully remove the cloth, since you will need to replace it when you're done painting the grille. Be careful not to deform the cloth's shape while removing it - this will make it very difficult to properly replace the cloth on the grille. Remove any adhesive residue from the back of the grille before beginning painting.

Painting The Grille

1. Prime the grille with a metal primer/bonder in a spray can. Carefully follow the manufacturer's directions on the can.
2. We recommend using water-based latex paint on the grilles. Thin the paint with a proper thinning agent to a ratio of 1:1 paint-to-thinner, and strain it through a standard mesh strainer to remove any lumps.

IMPORTANT: DUE TO ITS INCREASED DURABILITY, OIL-BASED PAINT SHOULD BE CONSIDERED FOR VP EXTREME SERIES SPEAKERS THAT ARE INSTALLED OUTDOORS.

3. Use a small touch-up gun or cap-spray gun with a #3 tip for painting.
 - (A) Set the nozzle with a medium to wide fan
 - (B) Set the pressure regulator to 60psi
 - (C) Lightly spray the front of the grille in 3 quick strokes from approximately 10 inches away
 - (D) Let the paint set for a minute, then turn the grille 90° and lightly spray the grille again in 3 quick strokes. Repeat this step until all four sides of the grille have been evenly painted evenly.
4. While the paint is still wet, inspect the grille and make sure that excess paint has not collected underneath the grille frame, and that none of the grille perforations are filled with paint. If any are, use compressed air to blow the paint out of the perforations.

IMPORTANT: IF YOU FIND ANY GRILLE PERFORATIONS THAT ARE PLUGGED WITH PAINT AFTER THE PAINT HAS DRIED, USE A STRAIGHT PIN OR SEWING NEEDLE TO CAREFULLY REMOVE THE PAINT.

5. Once the paint has thoroughly dried, replace the scrim cloth on the back of the grille and mount the grille on the speaker.

TWO (2) YEAR WARRANTY

We stand for the quality of our SONOS products. We offer a 2 year full warranty on all products sold. The details of this warranty are set out in our End User License and Warranty Agreement (EULA). A summary of the conditions of the SONOS Warranty is set out below. In the event that there is any conflict between this summary and the EULA, the EULA will control. Your local consumer protection laws may provide additional rules on warranty. The SONOS Warranty does not in any way restrict the rights that you may have under such rules. The SONOS Warranty covers defects in materials and workmanship in every SONOS product for two (2) years from the date of shipment from SONOS or the date of the original retail purchase from an Authorized SONOS Dealer. The SONOS warranty does not guarantee that SONOS products will at all times operate without interruption or will be error-free, or that all errors may be corrected. If you have a valid claim under the SONOS Warranty and have returned the product in accordance with the procedure set out below, we will repair or replace the defective product free of cost. If we determine that the problem is not covered under the SONOS Warranty, we will notify you and inform you of service or replacement alternatives that are available to you for an additional fee. The warranty period is not extended if we repair or replace your product.

Your SONOS Warranty is transferable with ownership, so if you give or sell the SONOS product to someone during the guarantee period, it's still covered. There are some exclusions to the SONOS Warranty, including but not limited to: problems that result from external causes such as accident, abuse or misuse;

Use that is not in accordance with SONOS' product instructions; products with missing or altered serial numbers; products which have had their housings opened or are otherwise tampered with; or problems caused by using third party accessories, parts, or components.

© 2018 SONOS Inc. All rights reserved.

SONOS, Play:1 and all other SONOS product names and slogans are trademarks or registered trademarks of SONOS, Inc. SONOS Reg. U.S. Pat & TM Off. Use of the Works with Apple badge means that an accessory has been designed to work specifically with the technology identified in the badge and has been certified by the developer to meet Apple performance standards.

Apple is a trademark of Apple Inc., registered in the U.S. and other countries.

CUT-OUT TEMPLATE

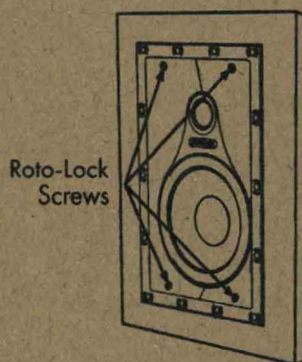
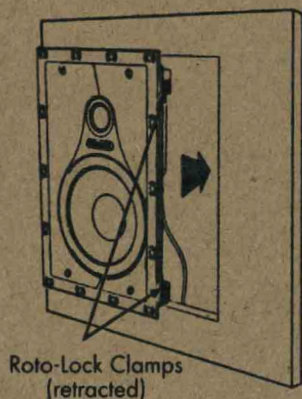

1. Perform an obstruction survey to be certain that there are no studs, conduit, pipes, heating ducts, pocket doors or air returns in the wall cavity that will interfere with the speaker.
2. Position this cutout template at the speaker location, then pencil an outline on the wall.
3. Cut the mounting hole using a keyhole or drywall saw.
4. Proceed with installation.

For more information, view the product guide at www.sonos.com

UNLOCK SONOS AUDIO ENHANCEMENTS



These speakers include exclusively-designed audio enhancements when used with a Sonos Amp. After you install the speakers and set up Amp, open the Sonos mobile app and go to **Room Settings** to choose the room the speakers are in.

Select **Advanced Audio > Detect Sonos Architectural** to unlock the audio enhancements and Trueplay settings.

SONOS[®] | SONANCE[®]