

BOSS[®]
AUDIO SYSTEMS
ELITE

 **Bluetooth**[®]



BV755B USER MANUAL

BLUETOOTH[®] | DVD/MP3/CD AM/FM RECEIVER
FEATURING 6.2" (157 mm) WIDESCREEN
TOUCHSCREEN DIGITAL TFT MONITOR



**To ensure safety while driving
and to comply with laws,
drivers should not watch video or
operate the video device while driving.**

Congratulations on your purchase of a **Boss Audio Systems**®
Multimedia Receiver.

It has been designed, engineered and manufactured to bring you
the highest level of performance and quality, and will offer you
years of entertainment pleasure.

CONTENTS

Specifications.....	1
Safety Notice.....	2
Accessories.....	3
Unit Installation.....	3
Remote Control Operation.....	4
Wires Connection Description.....	5
Panel Introduction.....	6
Main Menu Operation Instruction.....	7
Access Setup Interface.....	8
General Settings.....	7
Camera Settings.....	8
Clock Settings.....	8
Audio Settings.....	8
Tuner Settings.....	9
Illumination Settings.....	9
About Settings.....	10
Tuner Operation.....	10
DISC/CD/USB/SD Playback.....	11
DVD Mode operation.....	11
Media Playing— CD Audio.....	12
CD Source Menu	12
USB/SD Music/Video/Picture.....	12
Bluetooth Operation.....	13
Bluetooth Operation Menu.....	13
Bluetooth Keypad.....	13
Bluetooth Call.....	13
Bluetooth Phonebook.....	14
Bluetooth Phone Call History.....	14
Bluetooth Music Streaming-A2DP.....	14
Bluetooth Pair device.....	14
Photos.....	15
Camera/Aux/AV Menu.....	15
Troubleshooting.....	16

SPECIFICATIONS

Model No.	BV755B		
General features	Fixed front panel with 6.2 inch TFT screen FM/AM radio Fully compatible with DVD/VCD/CD/MP3/MPEG4/JPEG USB and SD card media play support Bluetooth audio stream and hands-free phone call AUX input AV input Video output Front/Rear view camera support Front, rear and subwoofer pre-amp output Max. 4 x 80W power output Steering wheel control (SWC)		
TFT screen	800 x 480 pixels		
SD	Up to 32G		
Working power	12V		
Max output	4 x 80W		
Working temperature	-20°C~70°C/-4°F ~158°F		
Size	6.71" x 3.8" x 6.3" (170.5 x 96.5 x 160 mm)		
Weight	1.58 kg / 3.48 lbs		
Compatible media			
Picture	JPG/JPEG/BMP		
Disc	CD/CD-R/CD-RW/DVD/DVD±R/DVD±RW		
Audio file	MP3/WAV		
Video file	Format	Video code	Audio code
	MPEG1	MPEG1	MP2
	MPG	MPEG2	MP2

SAFETY NOTICE

Please read and understand the following safety information before operating this unit.

- ⊘ The unit is suitable for 12V power supply (requires grounding). Do not connect it to 24V power supply in trucks or buses, or else it will be damaged.
- ⚠ Please use genuine discs instead of incompatible discs or the unit will be damaged and/or the service life will be shortened.
- ⚠ Do not replace the fuse without the guidance of qualified personnel or the unit may be damaged and/or catch fire.
- ⚠ Please follow the traffic laws and regulations and do not watch programs or operate the unit when you are driving to avoid accidents (excluding passengers watching through rear monitor).
- ⚠ To ensure safety and normal unit operation, please ask qualified personnel to install the unit. Do not disassemble or repair the unit without authorization. To avoid damage and accidents, please contact a local car audio distributor for details.
- ⊘ Do not put the unit in a moist environment or water to avoid electric shock, damage, and/or fire due to a short circuit.
- ⊘ The mechanical drive part of the monitor uses an automatic precision transmission component. Do not pull, push or rotate the unit by force or impact the TFT screen to avoid damaging the unit.
- ⚠ Do not insert the audio plug of the vehicle into the master unit directly. Please convert with the dedicated end cable provided by our company.
- ⚠ When installing the unit, prevent metal objects from falling into the master unit from the vents to avoid a short circuit and damaging the unit.

Safety Statement

- ⊘ For the safety of yourself and others, do not watch programs or operate the unit when you are driving. It is prohibited by law.
- ⚠ The back up camera function should be used as an auxiliary view only. We are not responsible for any accidents occurred during backing.

ACCESSORIES

Remote control.....	1
Wire harness.....	1
Mounting brackets.....	2
Bracket screws.....	8
Trim ring.....	1

UNIT INSTALLATION

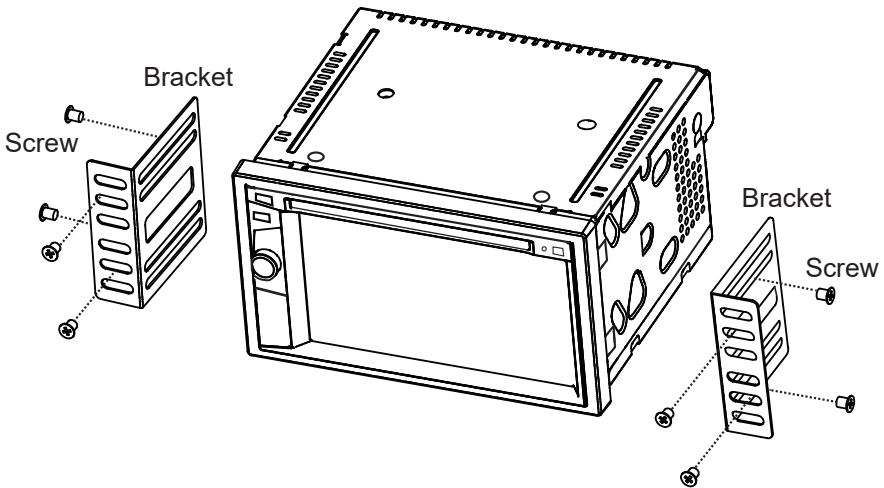

1. Put the 2 brackets to the left and right side of the unit.
2. Use the supplied screws to attach the brackets to the unit.
3. Once the screws are attached, the brackets can be adjusted forward or backward depending on the installation requirements.

REMOTE CONTROL OPERATION

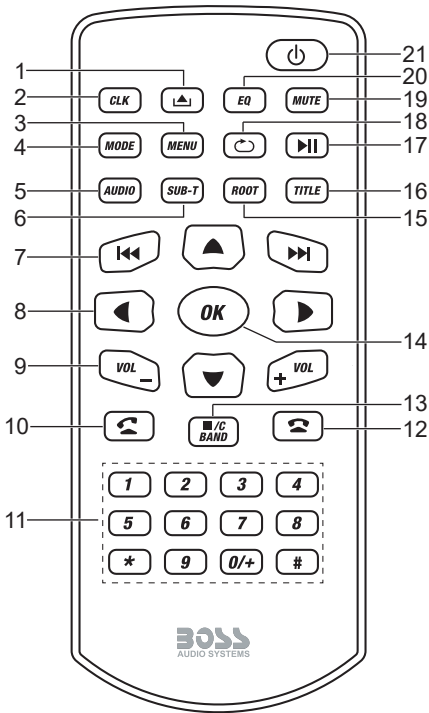

- 1 Eject the disc.
- 2 **CLK**
Display clock.
- 3 **MENU**
Switch between the home menu and the last selected source.
- 4 **MODE**
Switch between modes.
- 5 **AUDIO**
Select an audio language or channel for video.
- 6 **SUB-T**
Select a subtitle language for video.
- 7 **⏮ / ⏭**
 - Skip to the previous or next chapter, track or file.
 - In radio mode, tune to a station.

- 8 **⏪ / ⏩ / ▲ / ▼**
Navigation menus.
- 9 **VOL +/-**
Increase or decrease volume.
- 10 Answer or make a phone call.
- 11 **Numeric buttons**
 - Select a title/chapter/track.
 - In radio mode, select a preset station.
 - In Bluetooth phone mode, enter a phone number or a special symbol.
- 12 End or reject a phone call.
- 13 **■ / C BAND**
 - Stop playback.
 - In radio mode, select a tuner band.
- 14 **OK**
Confirm an entry or selection.
- 15 **ROOT**
Access the disc menu.
- 16 **TITLE**
Display the main menu of a video disc and start playback from the beginning.
- 17 **▶|**
Start, pause or resume playback.
- 18 Select a repeat play mode.
- 19 **MUTE**
Mute or restore volume.
- 20 **EQ**
Select a preset sound mode.
- 21 Switch the unit on or to standby.

WIRES CONNECTION DESCRIPTION

The Description of the Input/Output Interface

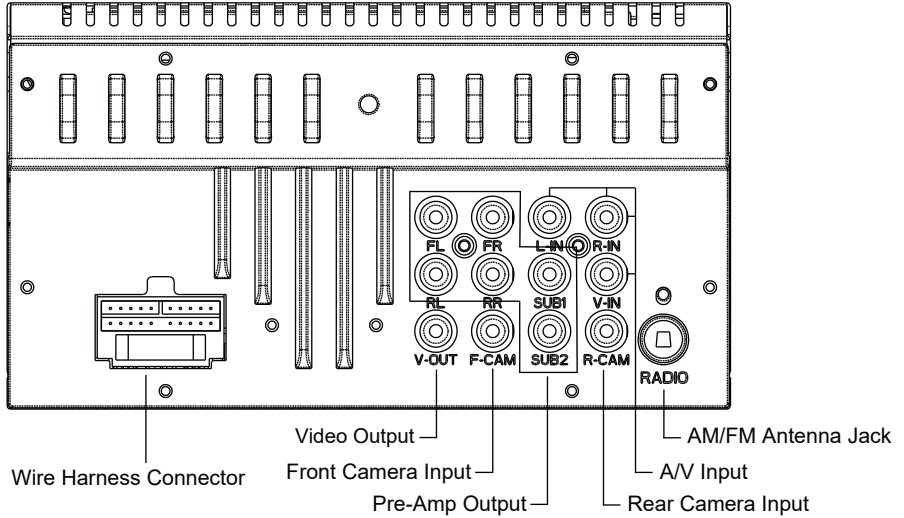

Wire Harness Explanation

Power

Yellow.....	Constant (+12v)
Red.....	Accessory (+12v)
Black.....	Ground (-)
Orange.....	Illumination Input (+12v)
Violet/Wht.....	Reverse Input (+12v)
Blue.....	Ant. Output (+12v, 500 mA)
Blue/Wht.....	Rem. Output (+12v, 500 mA)
Lt.Green.....	Parking Brake Input

Control

3.5mm.....	SWC Input
------------	-----------

Speaker Outputs

White.....	Left Front (+)
White/Blk.....	Left Front (-)
Gray.....	Right Front (+)
Gray/Blk.....	Right Front (-)
Green.....	Left Rear (+)
Green/Blk.....	Left Rear (-)
Purple.....	Right Rear (+)
Purple/Blk.....	Right Rear (-)

Camera Power

Red/Violet.....	Front Output (+12v, 500 mA)
Red/White.....	Rear Output (+12v, 500 mA)

PANEL INTRODUCTION

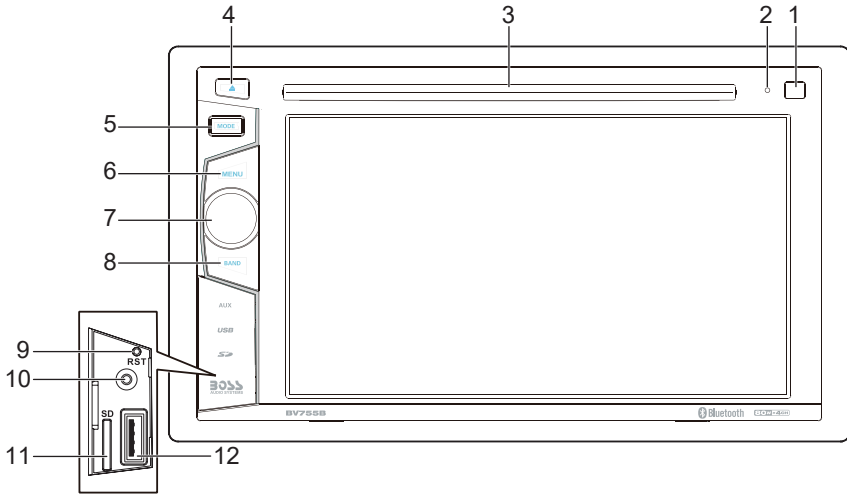

- 1 Remote sensor**
Aim the remote control directly at the sensor.
- 2 Built in microphone**
Pick up sound.
- 3 Disc slot**
Insert a disc.
- 4 ▲**
Eject the disc.
- 5 MODE**
Switch between modes.
- 6 MENU**
Switch between the home menu and the last selected mode.
- 7 Function knob**
 - Press and hold to turn the unit on or off.
 - Rotate to adjust volume.
 - In power on mode, press briefly to mute or restore volume.
- 8 BAND**
Switch between FM1, FM2, FM3, AM1 and AM2 radio.
- 9 Reset button**
Press the reset button if the unit fails to operate properly.
- 10 AUX jack (3.5mm)**
Connect to an external audio device for audio input.
- 11 SD card slot**
Connect to a Micro SD card for media play.
- 12 USB port**
Connect to a USB flash drive for media play.

MAIN MENU OPERATION INSTRUCTION

MAIN MENU 1

1. Tuner Interface
2. Streaming Interface
3. Disc Interface
4. Phone Interface
5. USB Interface
6. SD Interface
7. Front/Rear Camera Interface
8. AV INPUT Interface



MAIN MENU 2

9. AUX IN Interface
10. Setting Interface

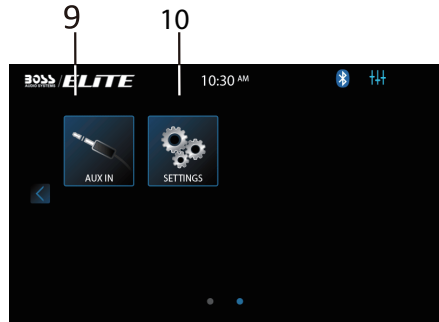

There are seven Setting Menus

GENERAL SETTINGS-Menu 1

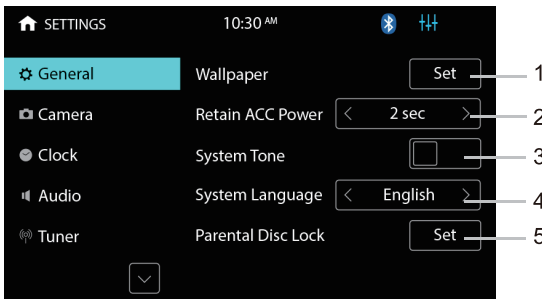

1. Touch to set wall paper for the home menu background.
2. Retain ACC Power: select how many seconds to delay shut down of the unit after the vehicle powers down.
3. When turned on, an audible beep tone confirms each function selection.
4. Touch to select Spanish or English.
5. Touch to select a parental control level.

ACCESS SETUP INTERFACE

CAMERA SETTINGS-Menu 2

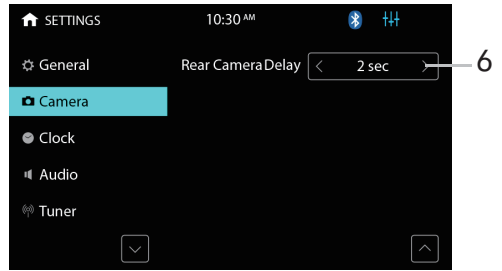
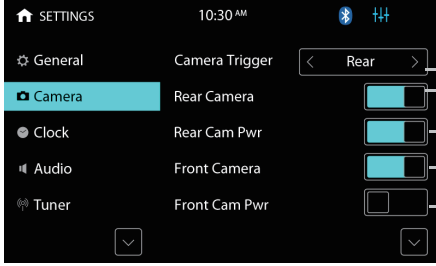

1. Camera Trigger: Touch to select Front/Rear/Off. Select to display the front or rear camera view, or no camera view when reversing.
2. Rear Camera: Touch to enable or disable the rear camera input.
3. Rear Cam Pwr: Touch to enable or disable power connection to the rear camera.
4. Front Camera: Touch to enable or disable the front camera input.
5. Front Cam Pwr: Touch to enable or disable power connection to the front camera.
6. Rear Camera Delay / Front Camera Delay: Touch to delay trigger of the rear/front camera view by a set time (1/2/3 seconds or off) when shifting the gear to the reverse position. Due to varying vehicle configuration, the rear/front view trigger can be delayed to suit the vehicle.

CLOCK SETTINGS-Menu 3

- a. Touch to set clock mode: 12/24 hour.
- b. Touch to set hour.
- c. Touch to set minute.
- d. Touch to set AM/PM at 12 hour mode.

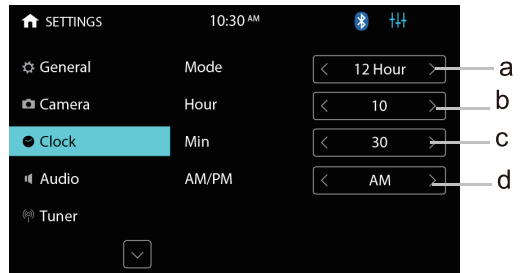

AUDIO SETTINGS-Menu 4

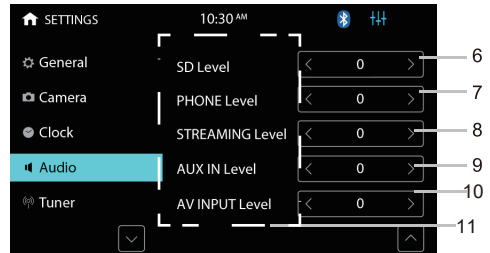
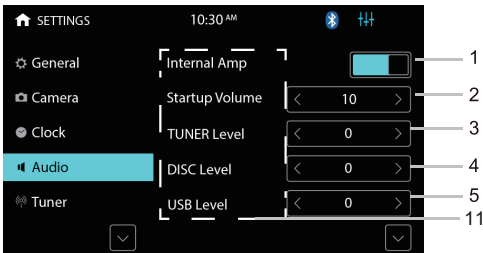

ACCESS SETUP INTERFACE

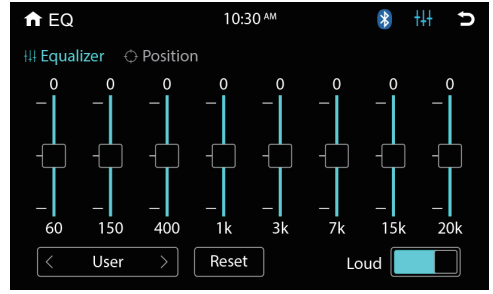
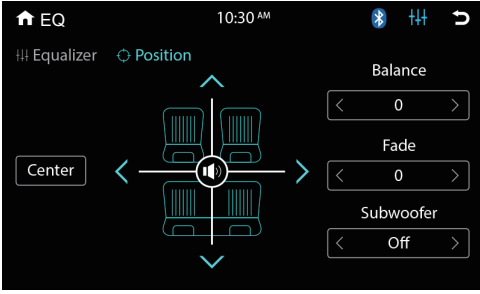

1. Touch to select whether to output sound from an external amplifier.
2. Startup volume: default volume.
 - ① If the volume at the last shutdown is less than this volume, the volume at the last shutdown will be used when rebooting;
 - ② if the volume at the last shutdown is greater than this volume, this default volume will be used when rebooting
- 3-10. Touch to set a particular volume level for each source.
11. Slide up or down to enter the previous or next menu interface.

TUNER SETTINGS –Menu 5

1. Select America or EU region you are in to receive radio stations.
2. Perform radio search and store radio stations in each radio band.
3. Select Local to receive strong signal only. Select Distance to receive both strong and weak signals
4. Select Stereo or Mono sound effect.

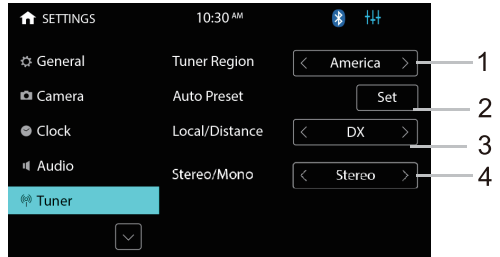

ILLUMINATION SETTINGS –Menu 5

1. Turn on or off the illumination detection function.
2. Set screen brightness.
3. Set screen contrast.

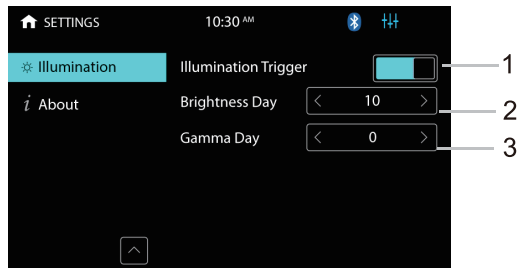

TUNER OPERATION

ABOUT SETTINGS –Menu 7

1. Touch to enter the touch calibration interface
2. Touch to view the version number of the machine.
3. Touch to restore the machine to factory status.
4. Touch to select whether it is necessary to display a warning interface when booting up.

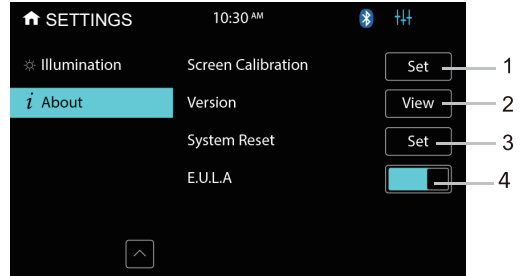

TUNER OPERATION

1. Touch  to go back to the home page
2. Short press to seek backwards, long press to enter manual mode
3. Short press to seek forward, long press to enter manual mode
4. Short press to select the preset station, long press to save current Freq

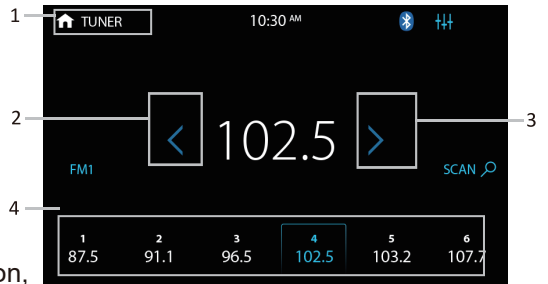

DISC/CD/USB/SD PLAYBACK

DVD MODE OPERATION

1. Touch to select title/chapter of DVD
2. Short press to move to the previous chapter, long press to rewind quickly.
3. Touch to playback/pause
4. Short press to move to the next chapter, long press to fast forward quickly.
5. Touch to enter DVD root menu
6. Go to the next page of the menu bar
7. Go to the previous page of the menu bar
8. Touch to change the repeat mode in the following sequence:
DVD:repeat all, repeat off, repeat chapter, repeat title
VCD(PBC off):repeat all, repeat off, repeat single
9. Touch to change random play mode
10. Touch to enter video adjust page
11. Touch to enter DVD title menu
12. Touch to select the subtitle language if the disc is recorded in multiple languages
13. Go to the next page of menu bar
14. Touch to switch video between 4:3 and 16:9
15. Touch to select DVD audio language
16. Touch to select DVD video angle

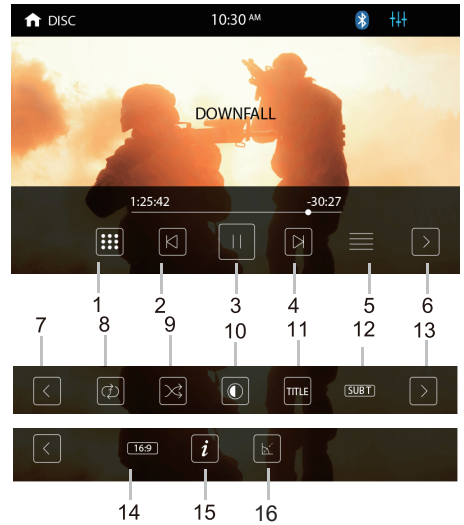

NOTE: When properly installed, a video cannot be displayed unless the parking brake is applied. If the parking brake wire is not installed correctly, the following message will appear.

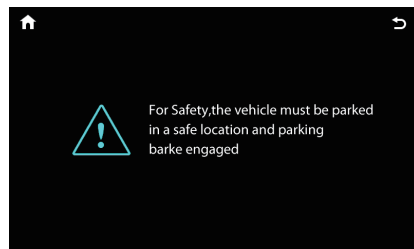

DISC/CD/USB/SD PLAYBACK

MEDIA PLAYING—CD AUDIO

1. Show the music's ID3 information
2. Time bar: show the total time and playing time of the present song
3. Touch to change play mode: repeat all, repeat directory, repeat single, sequential play and shuffle play
4. Touch to return to previous chapter
5. Touch to playback/pause
6. Touch to go to the next chapter
7. Touch to enter file list page



CD SOURCE MENU

Touch the SOURCE MENU (ICON 5) to access the CD track menu to view or change tracks manually. Touch again to return to playback.

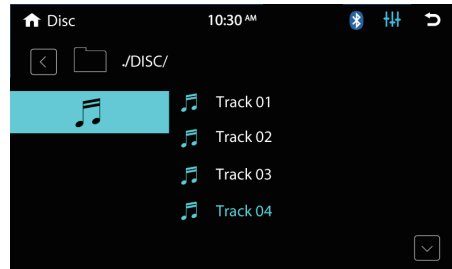

USB/SD MUSIC/VIDEO/PICTURE

Press USB/SD in the main menu. The music menu is similar to the disc music menu except there is more ID3 information on it (such as song name & singer).

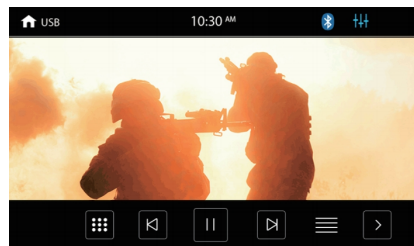
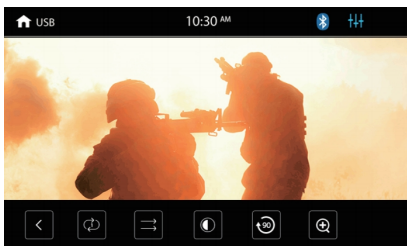
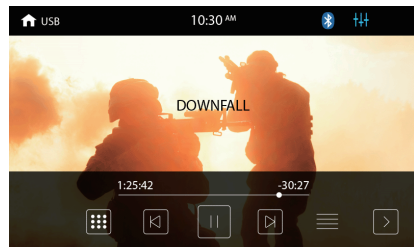
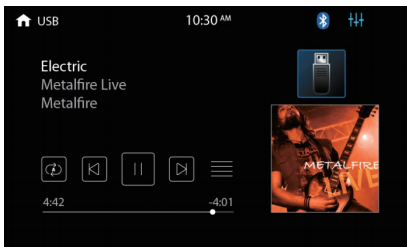

BLUETOOTH OPERATION

BLUETOOTH OPERATION MENU

Touch the phone icon to enter the Bluetooth function interface.

1. Bluetooth setting menu:

a. Turn Bluetooth on and off.

Turn on and the display loops between the gray Bluetooth icon, the white Bluetooth icon. The icon will turn blue when a phone is paired.

b. Connect automatically.

c. Answer automatically.

d. PIN code: the default password is "0000" and can be changed by clicking "0000".

e. Default Bluetooth name for this unit: Boss Audio BV755B.

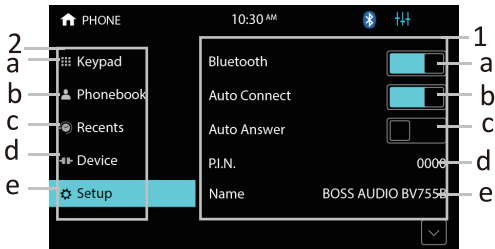

2. Function area:

a. Touch to see the dialing keypad. Users can dial phone numbers and make calls.

b. Touch to see the Bluetooth phonebook menu.

c. Touch to see the Bluetooth call history.

d. Bluetooth pairing interface.

e. Bluetooth setting menu.

1. Shows the number dialed in.

Touch  to delete wrong numbers.

2. Key area.

3. Touch to call out.

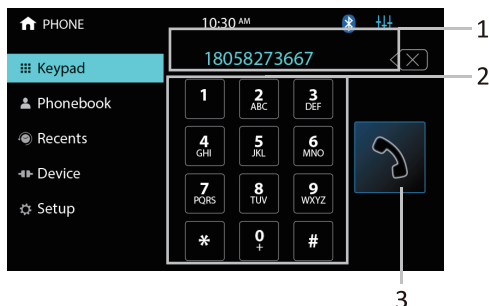

BLUETOOTH CALL

1. Show contact name.

2. Touch to select talk through phone or through Bluetooth.

3. Touch to mute or un-mute mic.

4. Keypad area.

5. Touch to hang up the phone call.

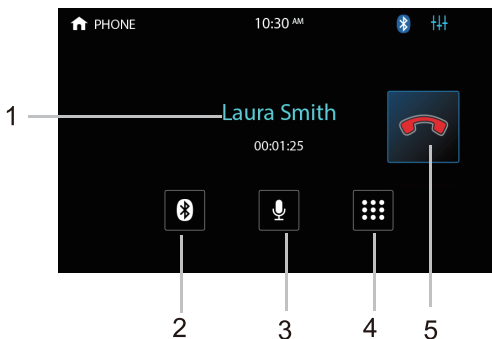

BLUETOOTH OPERATION

BLUETOOTH PHONEBOOK

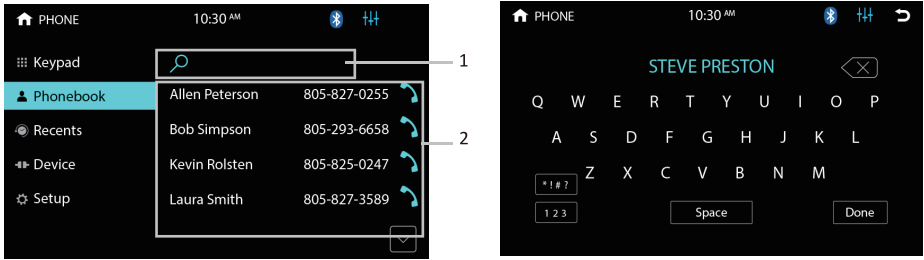

1. Touch to search for a name or phone number.
2. Contact list.

BLUETOOTH PHONE CALL HISTORY

1. Touch to sync phonebook.
2. Touch to show missed calls.
3. Touch to show the dialed phone numbers.
4. Touch to show the received phone numbers.

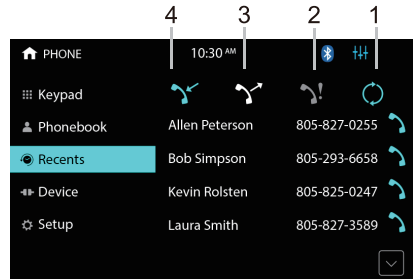

BLUETOOTH MUSIC-A2DP

1. Skip to the previous music file.
2. Start/pause/resume play.
3. Skip to the next music file.
4. Enter EQ setting menu.

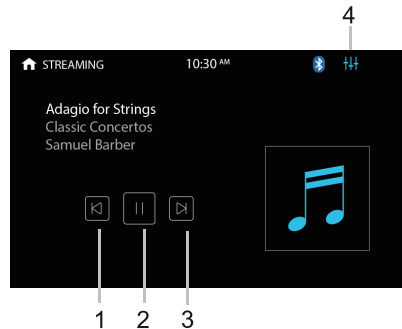

BLUETOOTH PAIRED DEVICE

You can disconnect the current Bluetooth connection by selecting "Device" -> "Disconnect this Device".

You can remove the currently connected device from the memory by selecting "Device" -> "Forget this Device".

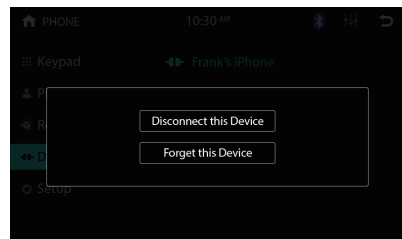

PHOTOS

1. Keypad: enter number to select file.
2. Skip to the previous picture.
3. PLAY/PAUSE: Touch to start picture playing mode. Touch again to pause. During picture playing mode, each picture will be played for 5 seconds and then automatically move to the next if the PLAY/PAUSE button is not pressed.
4. Skip to the next picture.
5. List: touch to enter file list.
6. Go to the next page of the menu bar.
7. Go to the previous page of the menu bar.
8. Select repeat mode.
9. Select random play mode.
10. Touch to enter the video adjust page.
11. Turn right 90 degrees.
12. Zoom out/in the present picture.



CAMERA/AUX/AV MENU

FRONT CAMERA:

Turn on the switching interface of rear camera and front camera at the same time

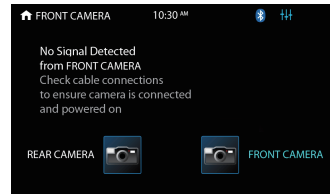

REAR CAMERA:

Rear view function. The rear view video signal can display automatically when reversing the car and then return the screen to the last source when the car is moved out of reverse.

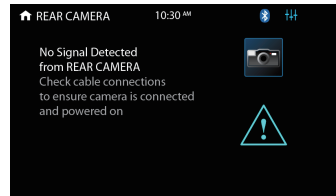

AUX IN:

External audio input function. Connect the audio device to the unit by the 3.5mm jack in front of the panel and touch AUX IN icon.

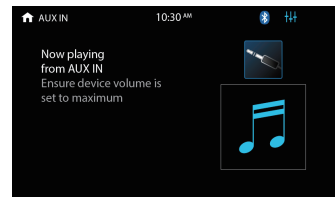

AV INPUT:

External video and audio input function. Connect the video and audio device to the unit by the RCA jacks and touch AV INPUT icon.

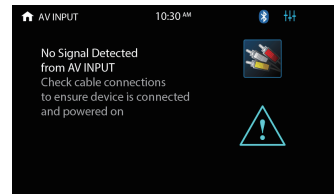

TROUBLESHOOTING

Media displayed	Cause	Corrective Action
Loading	Disc is being read	Wait until the reading finishes
No disc/Bad disc	Disc is dirty	Clean the disc
	Disc is upside down	Insert disc in right way
Unknown disc	Unsupported disc type	Check the disc and change
Error	Illegal mechanism operation	Press EJECT for 5s to reset loading mechanism
Problem	Cause	Corrective Action
Unit will not power on	Unit fuse blown	Install new fuse with right rating
	Car battery fuse blown	Install new fuse with right rating
	Illegal operation	Press the RESET button
Screen touch is insensitive	Place of touch screen is uncalibrated	Go to setup menu and set the calibration
No audio output	Improper audio output connection	Check wiring and correct
	VOLUME 0	Turn up the volume
Low audio output	Heavily biased volume balance	Check and adjust the channel balance to the center position
Poor sound quality or distortion	Speaker power rating not compatible with unit	Connect proper speakers
	Speaker short circuit	Check wiring
Weak station searching	Auto antenna is not properly connected	Connect the auto antenna properly
	LOCAL function is activated	Turn LOCAL function OFF

TROUBLESHOOTING

Problem	Cause	Corrective Action
No image	Incorrect connection to parking brake wire	Check wiring and correct
	Parking brake is not engaged	Stop vehicle in safe place and set parking brake ON
Flashing image or interference appears on screen	Improper video signal connections	Check wiring and correct
Improper image, improper height/width screen display	Improper aspect ratio setup	Use correct aspect ratio setting
Cannot insert disc	Disc already inside unit	Eject the current disc and insert the new one
Loss of audio, music stops	Disc is scratched or warped	Use a new one in good condition
	Disc is dirty or wet	Clean the disc



BOSS Audio Systems
3451 Lunar Court • Oxnard, CA 93030
www.bosssaudio.com
805-751-4853 Customer Service
Tech Support: www.bosssaudio.com/support



0821

iPod® and iPhone® are trademarks of Apple, Inc. registered in the U.S. and other countries. BOSS Audio Systems is not affiliated with Apple, Inc.

The Bluetooth® word mark and logos are registered trademarks owned by Bluetooth SIG, Inc. and any use of such marks by BOSS Audio Systems is under license. Other trademarks and trade names are those of their respective owners.