



# BE7ACP.WX USER MANUAL

APPLE CARPLAY® & ANDROID AUTO™ (WIRED, WIRELESS)

BLUETOOTH® | 340 WATTS | MP3-COMPATIBLE

DIGITAL MEDIA AM/FM RECEIVER

FEATURING 7" (178 mm) CAPACITIVE TOUCHSCREEN

AND MULTICOLOR ILLUMINATION OPTIONS





*Thank you for choosing BOSS Audio Systems!*

Sign up for Boss Audio Systems News and Promos by visiting us on the web at [www.bossaudio.com](http://www.bossaudio.com).

Be part of our community! Join us by signing up on the web at [www.bossinsiders.com](http://www.bossinsiders.com)

<b><i>IMPORTANT! Complete the information below and keep for your records.</i></b>	
<b>Model</b>	
<b>Serial Number</b>	
<b>Date of Purchase</b>	
<b><i>Note: Serial number is located on the packaging and the top of the product chassis.</i></b>	

# Table of Contents

## Important Information 4

About this Manual.....	4
Operation Warnings .....	4
Installation Warnings .....	5
Screen Care.....	5
Notice .....	5

## Basic Operation 6

What Comes in the Box .....	6
Control Panel.....	7
First Time Setup .....	8
Home Menu Description .....	9

## FM/AM Radio 10

Radio Home Screen .....	10
Tune to a Radio Station .....	10
Auto Store Radio Stations .....	10
Preset a Radio Station .....	10
Search via Frequency Input .....	10
FM Local and Distant.....	10
FM Stereo and Mono.....	10

## SiriusXM® Radio 11

Preparation .....	11
SiriusXM Home Screen .....	11
Select a Channel .....	12
Preset a Channel .....	12
Artist & Song Alerts.....	12
Set Artist & Song Alerts .....	12
Parental Control.....	13

## Apple CarPlay 14

Apple CarPlay Introduction .....	14
Wired Connection .....	14
Wireless Connection.....	14
Arrange your CarPlay Apps.....	15
Disable CarPlay Apps .....	15

## Android Auto 16

Android Auto Introduction .....	16
Wired Connection .....	16
Wireless Connection.....	16

## Bluetooth 17

First Time Connection.....	17
----------------------------	----

Enable Bluetooth Connection .....	17
Audio Streaming.....	17
Make a Call .....	18
Operation During a Call .....	18
Sync Phonebook and History.....	18
Search a Contact.....	18
Browse Call History.....	18
View Connection Status.....	18
Voice Assistant (Push-To-Talk) .....	18

## USB 19

USB Playback.....	19
Audio/Video/Photo Play Switching .....	19
Audio Playback.....	19
Video Playback .....	19
Photo Playback.....	19

## Other External Devices 20

Audio/Video Input .....	20
Playback.....	20
Audio Input.....	20
Video Input .....	20
Manual Camera Trigger.....	20
Automatic Camera Trigger .....	20

# Table of Contents

<b>Set Sound Effects</b> .....	<b>21</b>	<b>Bluetooth Settings</b> .....	<b>24</b>	<b>Connections</b> .....	<b>28</b>
Sound Mode and Equalizer Setting .....	21	<b>Radio Settings</b> .....	<b>25</b>	Power and SWC Input Wiring .....	28
Volume Balance Setting .....	21	Radio Region Selecting .....	25	Speaker Wiring .....	29
Crossover Frequency Setting .....	21	RDS/RBDS Activation .....	25	Parking Brake Wiring .....	30
Time Alignment Setting .....	21	RDS/RBDS Information Display .....	25	SiriusXM/Wireless/GPS .....	31
<b>General Settings</b> .....	<b>22</b>	RDS/RBDS Traffic Announcement .....	25	AV/Radio .....	32
System Tone and Shutdown Delay .....	22	RDS/RBDS Alternative Frequency .....	25	Mic/Camera/CarPlay/Android Auto .....	33
Set Date and Time Manually .....	22	<b>Camera Settings</b> .....	<b>25</b>	Hands-Free Mic Installation .....	34
Set Date and Time Automatically .....	22	Camera Trigger Control .....	25	<b>Troubleshooting</b> .....	<b>35</b>
Language Setting .....	22	Parking Assist Guidelines Setting .....	26	<b>Specifications</b> .....	<b>37</b>
Steering Wheel Control Retention .....	22	<b>System Information</b> .....	<b>26</b>		
<b>Audio Settings</b> .....	<b>23</b>	Firmware Version Information .....	26		
Loudness and Sound Effect Setting .....	23	Firmware Update .....	26		
Startup Volume Setting .....	23	Resetting the Unit .....	26		
Initial Volume Setting for Other Sources .....	23	<b>Unit Installation</b> .....	<b>27</b>		
Customization of a Source Volume .....	23	Installation Dimensions .....	27		
<b>Display Settings</b> .....	<b>24</b>	Double DIN Opening Installation .....	27		
Wallpaper Setting .....	24				
Screen Setting .....	24				
Automatic Dimming Control .....	24				
Panel Button Light Setting .....	24				



# Important Information

## About this Manual

To understand how to properly use your new BOSS Audio Systems product, it is recommended to read this user manual in its entirety, and keep it in a safe place for future reference.

This manual uses illustrations to show you how to use this product safely and alert you to potential dangers resulting from improper connections and operation. It is important to fully understand the meaning of each one of these illustrations in order to use this manual and system properly.



The **WARNING** illustration denotes very important instructions. Failure to follow them can result in damage to equipment, serious injury or death.



The **CAUTION** illustration denotes important instructions. Failure to follow them can result in injury or material property damage.



The **IMPORTANT NOTE** illustration denotes important instructions for product features and limitations. Failure to follow them will result in product misuse and/or unexpected behavior.

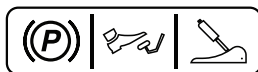

The **PARKING BRAKE** illustration denotes features that can only be used with vehicle not in motion and parking brake engaged. Failure to follow them will result in product misuse and/or unexpected behavior.

## Operation Warnings



### **OPERATION OF THIS PRODUCT WHILE DRIVING IS DANGEROUS.**

Users should come to a complete stop and in a safe location before using any feature that requires extended periods of time.

### **PAY ATTENTION TO ROAD CONDITIONS.**

Avoid operating product under dangerous road conditions and abide by regulations over information contained on the map display. Follow traffic restrictions and circumstances while driving.

### **OPERATE AT SAFE VOLUME LEVELS.**

Excessive volume levels may obstruct sounds such as emergency vehicle sirens or road warning signals; can be dangerous and may result in an accident. Listening at high volume levels can also cause hearing damage.

### **DO NOT WATCH VIDEO WHILE DRIVING.**

Watching video content may distract the driver from looking ahead of the vehicle and can potentially cause an accident.

## Installation Warnings

### **CERTIFIED PROFESSIONAL INSTALLATION.**

Installation and service repair of this product by anyone without professional training and experience in consumer electronics and mobile vehicle accessories may be dangerous and result in electric shock, injury or other hazards.

# Important Information

## DISCONNECT BATTERY.

To avoid potential shorts in the electrical system, be sure to disconnect the **NEGATIVE (-)** terminal cable before beginning this product installation. Failure to do so may result in electric shock, fire, damage to product and/or property damage.

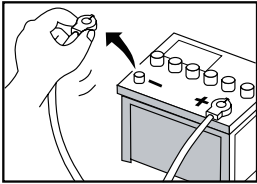

## DO NOT DISASSEMBLE OR ALTER PRODUCT.

Disassembly of product may result in an accident, fire or electric shock.

## REPLACE FUSE WITH THE CORRECT RATING.

Failure to do so may result in fire or property damage.

## PARKING BRAKE INSTALLATION WIRING.

Installing this product incorrectly may enable the user to watch video while driving. This may cause distraction, preventing the driver to focus on the road and potentially cause an accident. The driver and passengers can be severely injured.



## Screen Care

### USE

This head unit utilizes a Capacitive Touchscreen, the same type that is used on high-end mobile devices. It should be used for and cared for like that type of device. As with all capacitive type technology, if your fingers are wet or sweaty, it will not function properly.

Do not allow any sharp objects to come in contact with the screen.

### CLEANING

To clean the screen, use a dry or slightly damp micro fiber type cloth to clean. Do not use ammonia, window cleaner, or any other type of household chemicals to clean the screen. Abrasives should never be used.

Best to clean the screen when the unit is powered off, cool and not in direct sunlight.

## Notice



Apple CarPlay is a trademark of Apple Inc.

iPhone® is a trademark of Apple Inc., registered in the U.S. and other countries.

Use of the Apple CarPlay logo means that this user interface meets Apple performance standards.

Apple is not responsible for the operation of this device or its compliance with safety and regulatory standards. Please note that the use of this product with iPhone may affect wireless performance.



Android Auto is a trademark of Google LLC.



SiriusXM and all related marks and logos are trademarks of Sirius XM Radio, Inc. All rights reserved.



The Bluetooth® word mark and logos are registered trademarks owned by Bluetooth SIG, Inc. and any use of such marks by BOSS Audio Systems is under license. Other trademarks and trade names are those of their respective owners.

# Basic Operation

## What Comes in the Box

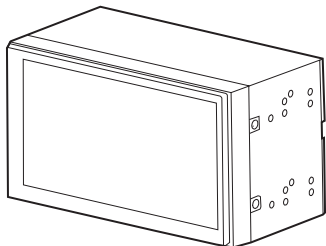

Head Unit

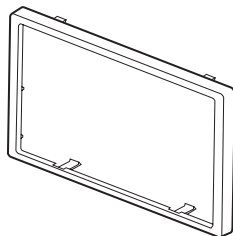

Trim Ring

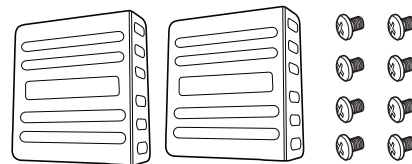

2x Mounting L-Brackets  
8x Bolts (M5 x 6mm)

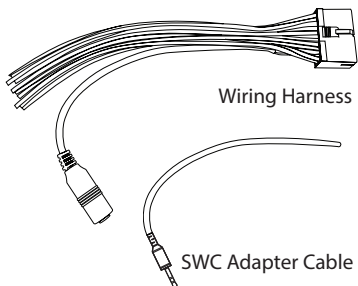

Wiring Harness

SWC Adapter Cable

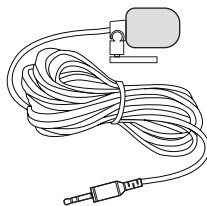

Microphone with 3.5mm Plug and Sticky Base

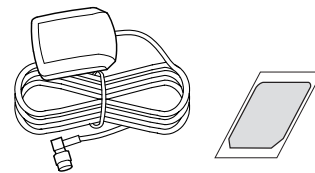

GPS Antenna + Antenna Base Sticker  
(Auxiliary use with CarPlay/Android Auto navigation)

# Basic Operation

## Control Panel

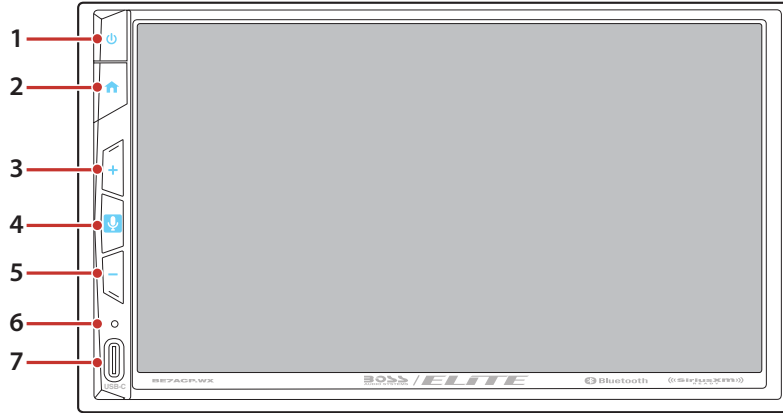

### 1 Power/Mute button

- Press to power on the unit.
- Press and hold to power off the unit.
- When powered on, press to mute or restore the volume.

### 2 Home button

- Press to switch between the home menu and the last selected source.
- When powered on, press and hold to turn the screen off.

### 3 Volume up button

### 4 Voice assistant (Push-To-Talk)

- Press to activate voice assistant.
- Enable Apple CarPlay, Android Auto or Bluetooth connection to use voice assistant.

### 5 Volume down button

### 6 Reset button

- Use a needle or pin to press the button. Reset the unit if the unit fails to function normally.

### 7 USB-C port (1.5A charging port)

- Media audio, video or picture input from a USB flash drive.
- If needed, use a USB-C adapter (not included) to fit your USB flash drive into the USB-C port.

### TIP:

- When the unit is powered off, touch the screen to turn on or off time/date display.

# Basic Operation

## First Time Setup

When you turn on the unit for the first time or reset the unit, the initial setup page will appear.

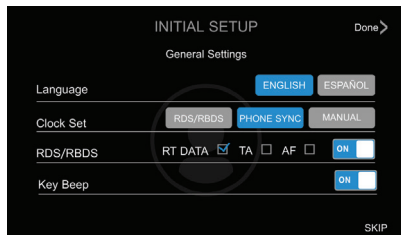

### Set Language

**[Language]:** Select English or Español as a display language for menu.

You can set language later. From the home menu, select **[SETTINGS] > [General] > [Language]**.

### Set Clock

**[RDS/RBDS]:** Automatically set date and time from RDS/RBDS broadcast.

**[PHONE SYNC]:** Automatically set date and time from Apple CarPlay.

**[MANUAL]:** Set date and time manually.

### Set date and time manually

Select **[MANUAL]** to access time, date and time zone settings.

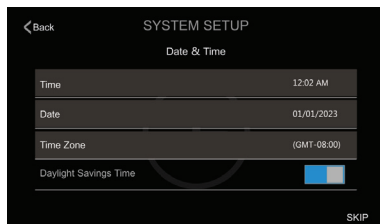

**[Time]:** Access time setting screen. Swipe up and down to set hours, minutes, and AM/PM or 24 hour format respectively.

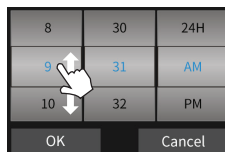

**[Date]:** Access date setting screen. Swipe up and down to set year, month, and day respectively.

**[Time Zone]:** Select a time zone in your current location.

**[Daylight Savings Time]:** Enable to adjust daylight saving time automatically.

You can set date and time later. From the home menu, select **[SETTINGS] > [General] > [Date & Time]**.

### Set RDS/RBDS Radio

The RDS/RBDS (Radio Broadcast Data System) enables FM stations to send additional information when broadcasting radio.

**[RT DATA]:** Enable/disable display of RDS/RBDS information (i.e. station name, program type or other dynamic/static message).

**[TA]:** Enable/disable traffic announcement (TA).

**[AF]:** Enable/disable switching to alternative frequency (AF) for the same tuning program.

When enabled, the unit will automatically locate the same tuning program on other stations and select the strongest signal of those being broadcast.

**[ON]/[OFF]:** Enable/disable RDS/RBDS features.

You can set RDS/RBDS later. From the home menu, select **[SETTINGS] > [Radio] > [RDS/RBDS]**.

### Enable/Disable System Tone

**[Key Beep]:** When Off is selected, sound will not be made when touching a button or option on the screen.

# Basic Operation

## Home Menu Description

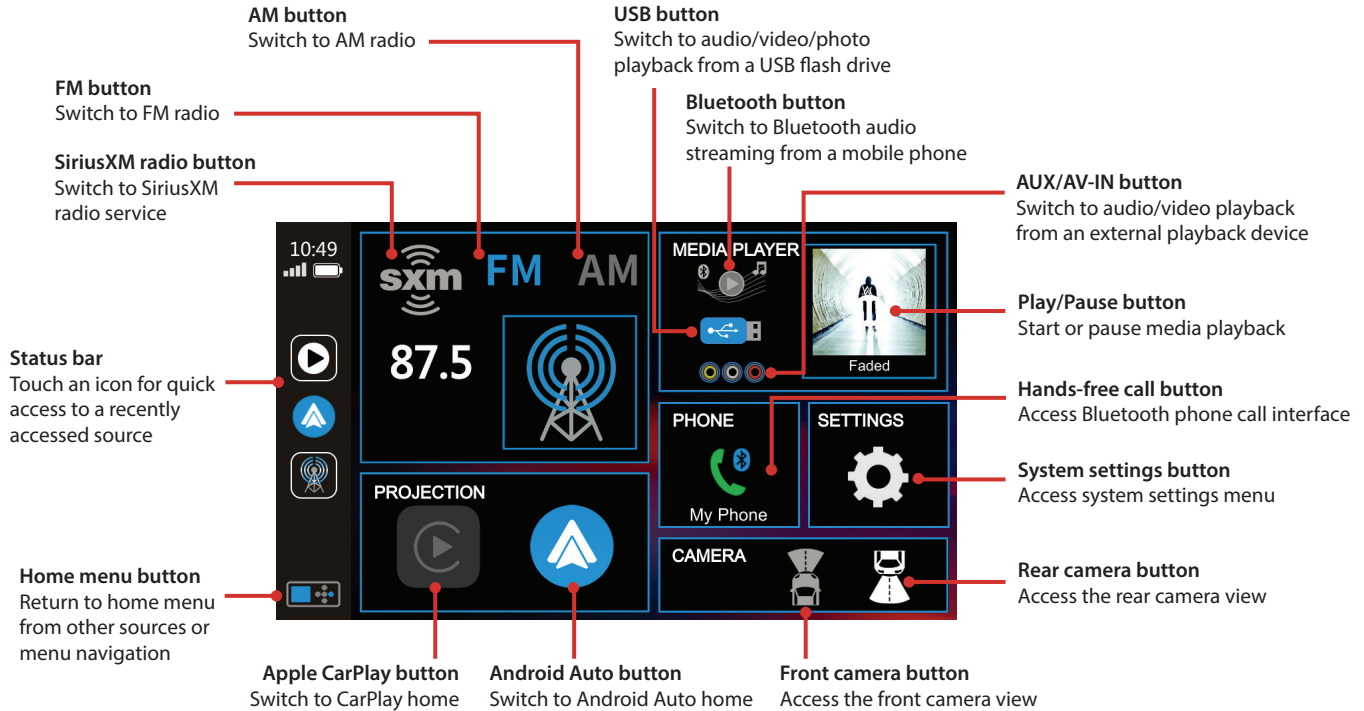

# FM/AM Radio

## Using FM/AM

### Radio Home Screen

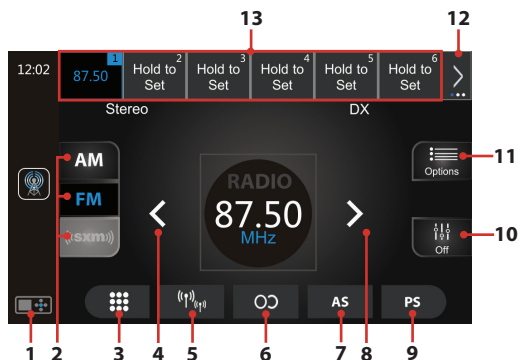

- 1 Return to the home menu.
- 2 Switch between AM, FM and SiriusXM radio.
- 3 Search for a radio station by frequency input.
- 4 Touch to tune to a station in auto seek mode. Touch and hold to switch between auto and manual seek mode.
- 5 Switch between local and distant station reception (only applicable to FM).
- 6 Switch between Stereo and Mono reception (only applicable to FM).
- 7 AS (Auto Scan): Search and store FM or AM stations.

- 8 Touch to tune to a station in auto seek mode. Touch and hold to switch between auto and manual seek mode.
- 9 PS (Preset Scan): Preview each stored station for five seconds. Touch the button again to stop the scan.
- 10 Select a preset sound mode.
- 11 Access radio settings (e.g. RDS/RBDS options). (P.25)
- 12 Access more stored stations.
- 13 Select a preset station. Touch and hold to save the current station as a preset.

### Tune to a Radio Station

In auto seek mode, touch briefly < or > to tune to a station.

Touch and hold < or > to switch between auto and manual seek mode.

**To fine tune a station**, in manual seek mode, touch < or > to change frequencies in steps.

### Auto Store Radio Stations

Touch [AS] on the display. Up to 18 FM or 12 AM stations will be stored.

### Preset a Radio Station

Touch and hold a preset number in the top bar of the display. The current station will be stored as a preset.

### Search via Frequency Input

Touch  to display a numeric keypad. Input a station frequency to find your station.

### FM Local and Distant

Touch  to select local or distant station reception. "LOC" display indicates local reception, "DX" display for distant reception.

Select "DX" when most FM stations are weak (e.g. in the countryside). Stations with both strong and weak signals will be received.

Select "LOC" when most FM stations are strong enough (e.g. in urban areas). Only the stations with strong signal will be received.

### FM Stereo and Mono

Touch  to select Stereo or Mono reception.

When FM signal is weak, select Mono to improve sound quality (stereo will be lost).

# SiriusXM Radio

## Using SiriusXM Radio

SiriusXM is where moments happen. It brings you ultimate entertainment.

- The widest, deepest variety of music, ad-free.
- More games, more sports, more coverage than anywhere.
- The most extensive entertainment, complete news coverage and every kind of comedy.
- Listen in your car, on your phone, online and at home.

A SiriusXM-Connect Vehicle Tuner and subscription are required. For more information, visit [www.siriusxm.com](http://www.siriusxm.com).

## Preparation

### 1. Connect a SiriusXM-Connect Vehicle Tuner (not included) to the SiriusXM-Ready® connector on the back of this unit. (P.31)

After installing your SiriusXM-Connect Vehicle Tuner and antenna, power on the head unit and select SiriusXM mode. You should be able to hear the SiriusXM preview channel on Channel 1.

If you cannot hear the preview channel, please check the installation instructions to make sure your SiriusXM-Connect Tuner is properly installed.

### 2. Check your Radio ID for activation.

The SiriusXM Radio ID is required for activation and can be found by tuning to Channel 0 as well as by looking on the label found on the SiriusXM Vehicle Tuner and its packaging.

- The Radio ID does not include the letters I, O, S or F.

### 3. Activate the subscription.

For users in the U.S.A.:

Visit [www.siriusxm.com/activatenow](http://www.siriusxm.com/activatenow), or call SiriusXM Listener Care at 1-866-635-2349

For users in Canada:

Visit [www.siriusxm.ca/activate](http://www.siriusxm.ca/activate), or call SiriusXM Customer Care at 1-888-539-7474

### 4. Confirm the activation.

As part of the activation process, the SiriusXM satellites will send an activation message to your SiriusXM Vehicle Tuner. When your head unit detects that the Tuner has received the activation message, your head unit will display [Subscription Updated].

Once subscribed, you can tune to channels in your subscription plan. Note, the activation process usually takes 10 to 15 minutes, but may take up to an hour. Your head unit will need to be powered on and receive the SiriusXM signal to obtain the activation message.

## SiriusXM Home Screen

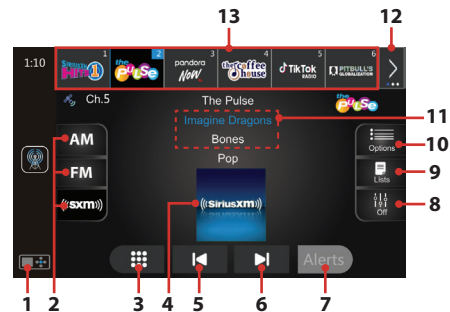

- 1 Return to the home menu.
- 2 Switch between AM, FM and SiriusXM radio.
- 3 Search a channel by input of channel number
- 4 Album Art: Display the image that represents the current music channel. When Album art image is not available, the channel logo or SiriusXM logo will be displayed. Compatible with SXV200 or later (SiriusXM Vehicle Tuner). Not all music channels contain album art images.
- 5 Select the previous channel.
- 6 Select the next channel.
- 7 View the alerts list for the saved artist names and song titles.



# SiriusXM Radio

## Using SiriusXM Radio

- 8 Select a preset sound mode.
- 9 Access alerts/category/channel list to enable alert or select a channel.
- 10 Access SiriusXM radio settings.
- 11 Artist/song name display zone (touch the zone to save the current artist name or song title as alert).
- 12 Access more channel presets.
- 13 Select a stored channel; touch and hold to preset the current channel.  
Channel Logos: Display SiriusXM channel logos to allow for a graphical representation of the current channel identifier.

### Select a Channel

You can select a channel via one of the followings.

- Touch **◀** or **▶** to select the previous or next channel.
- Touch **[Lists]** to access the channel and category lists. Find a channel by category, or artist, song or content info.
- Touch **⋮** to display the numeric keypad. Input a channel number.
- Touch a channel logo at the top of the home screen to select a preset channel.

### Preset a Channel

Touch and hold a preset number in the top bar of the screen. The current channel will be stored as a preset. Repeat the step to preset more channels.

### Artist & Song Alerts

When your favorite artist or song is broadcast on another channel, an alert message will appear to let you switch the current channel to the relevant channel.

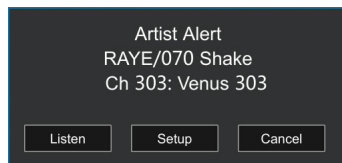

**[Listen]:** Switch to the channel where your set artist or song is being broadcast.

**[Setup]:** Display the alerts setting menu in case of deactivating alert feature.

**[Cancel]:** Skip the alert and stay tuned to the current channel.

### Set Artist & Song Alerts

#### Step 1: Save as Alerts

1. When listening to your favorite artist/song, touch the **artist/song name display zone** on the home screen, as shown in the red box below.

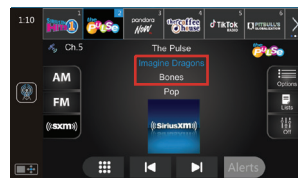

2. An prompt is displayed for you to set artist or song alert.

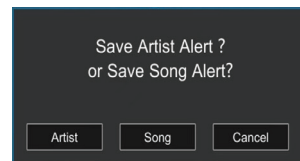

3. Touch **[Artist]** or **[Song]** from the prompt. The artist name or song title will be saved into the alert list.  
Up to 50 artist/song alerts can be saved.

# SiriusXM Radio

## Using SiriusXM Radio

### Step 2: Enable Alerts

1. From the SiriusXM home screen, touch **[Lists]** > **[My Alerts]** to access the alert list where the artist names and song titles are saved.

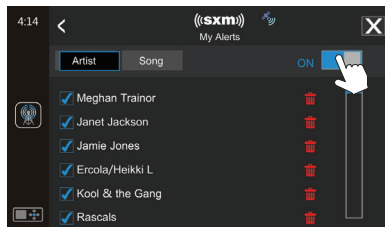

2. Touch **[Artist]** or **[Song]** tab, and select each artist or song from the alert list. A check mark appears beside the selected item.  
To delete an artist or song from the alert list, touch .
3. Enable alert function. Touch **[ON/OFF]** switch on the alert list.

### Parental Control

This feature allows you to restrict access to any SiriusXM channels, including those with mature content. A password is required to tune to a locked channel.

1. From the SiriusXM home screen, touch **[Options]** > **[Parental Control]**. A numeric keypad is displayed.



2. Enter 4-digit password (0000 as default) to access the channel list.
3. In the channel list, select a channel to lock. When a channel is locked, a lock icon is displayed beside the locked channel name.

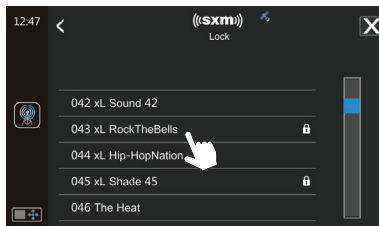

### Change Your Password

You can change the password for the parental control.

From the SiriusXM home screen, touch **[Options]** > **[Change Passcode]**, enter your current 4-digit password (0000 as default), then enter your new password.

# Apple CarPlay

## Using CarPlay

### Apple CarPlay Introduction

CarPlay provides a smarter, safer way to use your iPhone while driving. The apps on your iPhone can be loaded and displayed on the screen of this unit. Thus, you can navigate, call, control your music and so more with hands-free control on your mobile phone.

For more details about Apple CarPlay, visit <https://www.apple.com/ios/carplay>.

### Compatible iPhones

CarPlay works with iPhone 5 and all the way up to the most recent versions.

### Wired Connection

To enable CarPlay connection, connect your iPhone to the unit's rear USB port labeled "Apple CarPlay", using an Apple-certified USB cable with factory length or shorter (not included). (P.33)

Before the initial connection, enable Wi-Fi and Bluetooth on your iPhone. You will be prompted to enable wireless CarPlay on your iPhone during initial connection.

### Wireless Connection



For first-time use of wireless CarPlay, you need to enable wireless CarPlay use on your iPhone via either of the following pairing.

- On your iPhone, enable Wi-Fi, and access **Settings > Bluetooth** then select "BOSS AUDIO BE7ACP.WX" for Bluetooth pairing. Make sure to enable wireless CarPlay use when prompted on your iPhone.
- Initial wired connection to enable wireless CarPlay use on your iPhone.

#### IMPORTANT NOTE

If you do not allow wireless CarPlay use during initial Bluetooth pairing, wireless CarPlay will be disabled on your iPhone. To use wireless CarPlay later, you need to manually enable CarPlay on your iPhone (access **Settings > General > CarPlay > paired device** then enable CarPlay). When CarPlay is enabled, hands-free calls and streaming through Bluetooth is disabled.

### Switch between CarPlay and Bluetooth Use

From the unit's home screen, touch  to access the device list, then touch the iPhone name or  to enable CarPlay or Bluetooth use.

### CarPlay Home Menu Description



- 1 **Menu bar:** Touch an app icon for quick access.
- 2 **CarPlay home button:** Return to the CarPlay home screen.
- 3 **Unit's home button:** Exit the CarPlay screen and return to the unit's home menu.
- 4 **Apps loaded from the iPhone.**

### Use Voice Assistant

Press  on the unit's front panel to activate voice assistant, then speak your command.

Make sure the supplied external microphone is connected to the unit. (P.33)

# Apple CarPlay

## Using CarPlay

### Arrange your CarPlay Apps

You can add, remove, or arrange the order of the apps on the CarPlay screen of the unit.

1. On your iPhone, go to **Settings > General > CarPlay**, select this unit's name from the device list (shown below). Then select **Customize** to access CarPlay apps.

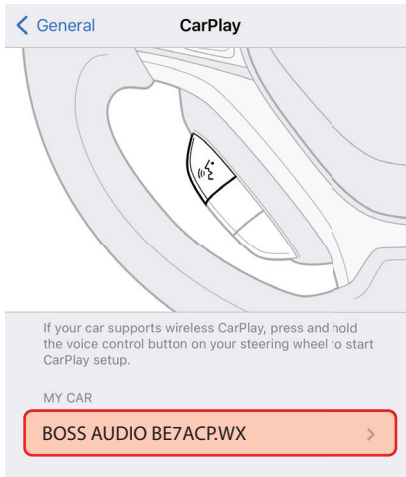

2. Touch and drag an app (☰) to change the order of the app.

Touch **−** or **+** to remove and add apps.

Only apps with **−** or **+** can be removed from CarPlay or added in CarPlay.

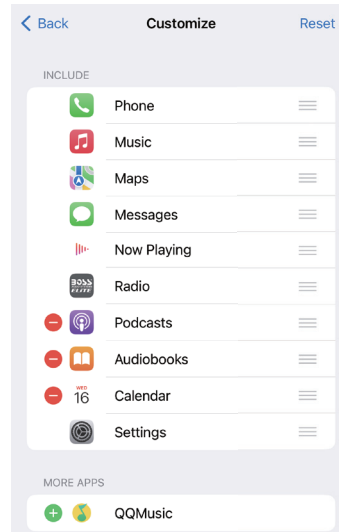

### Disable CarPlay Apps

You can disable all CarPlay apps to restrict CarPlay use on this unit.

On your iPhone, go to **Settings > Screen Time > Contents & Privacy Restrictions > Allowed Apps > CarPlay**.

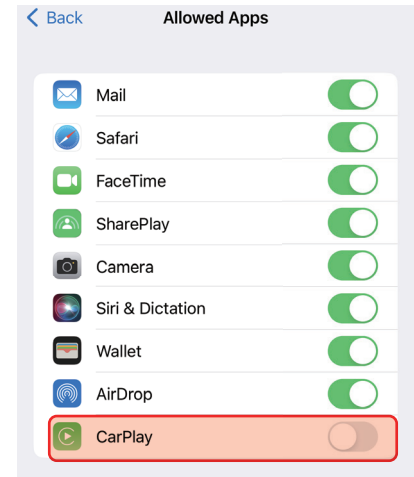

# Android Auto

## Using Android Auto

### Android Auto Introduction

Android Auto allows the apps on your Android phone to be loaded and displayed on the screen of this unit. Thus, you can navigate, call, control you music and so more with hands-free control on your mobile phone.

For more details about Android Auto, visit <https://www.android.com/auto>.

### Compatible Android Phones

- Wired connection: Android 6.0 and later.
- Wireless connection: Android 11.0 and later

### Android Auto App

- Phones with Android 9.0 and earlier needs Android Auto app downloaded from Google Play Store.
- Phones with Android 10 and above do not need to download Android Auto app.

### Wired Connection

To enable Android Auto connection, connect your Android phone to the unit's rear USB port labeled "**Android Auto**", using a certified cable with factory length or shorter (not included). (P.33)

Before the initial connection, enable Wi-Fi and Bluetooth on your phone. Wireless Android Auto use will be enabled on your phone during initial connection.

### Wireless Connection



For first-time use of wireless Android Auto, you need to enable wireless Android Auto use on your phone via either of the following pairing.

- On your Android phone, enable Wi-Fi, and access **Settings > Bluetooth** then select "**BOSS AUDIO BE7ACP.WX**" for Bluetooth pairing to enable wireless Android Auto use.
- Initial wired connection to enable wireless Android Auto use on your phone.

#### **IMPORTANT NOTE**

When Android Auto is enabled, hands-free calls and streaming through Bluetooth is disabled.

### Switch between Android Auto and Bluetooth Use

From the unit's home screen, touch  to access the device list, then touch the phone name or  to enable Android Auto or Bluetooth use.

### Android Auto Home Menu Description

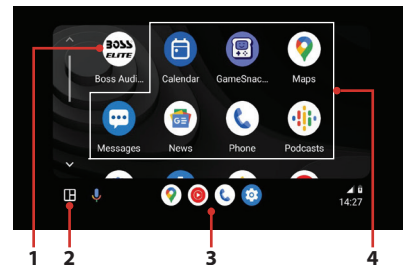

- 1 Unit's Home button:** Exit the Android Auto screen and return to the unit's home menu.
- 2 Android Auto Home button:** Return to the Android Auto home screen.
- 3 Menu bar:** Touch an app icon for quick access.
- 4 Apps loaded from the Android Phone.**

### Use Voice Assistant

Press  on the unit's front panel to activate voice assistant, then speak your command.

Make sure the supplied external microphone is connected to the unit. (P.33)

# Bluetooth

## Connection

### IMPORTANT NOTE

Bluetooth on the unit is enabled only when CarPlay or Android Auto is disabled. Make sure your CarPlay or Android Auto is disabled for Bluetooth use.



Compatibility with all mobile devices is not guaranteed.

### First Time Connection

Before you can stream audio or make phone calls through Bluetooth, pair the device with this unit.

Bluetooth pairing can be made through initial connection to CarPlay (P.14) or Android Auto (P.16).

Or, follow the instructions below to complete Bluetooth pairing.

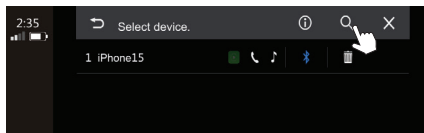

From the unit's home screen, touch  to access the device list, then touch  to search for available Bluetooth devices and select your Bluetooth device name to pair.

When prompted during pairing, select "Allow" on your mobile phone so that your phonebook and call history can be downloaded and displayed on the screen of this unit.



### Enable Bluetooth Connection

When CarPlay/Android Auto is enabled, Bluetooth connection will be disabled. In this case, you need to enable Bluetooth connection.

From the unit's home screen, touch  to access the device list then touch . Touch the icon again to disconnect Bluetooth connection.



When Bluetooth connection is enabled, CarPlay/Android Auto will be disabled.

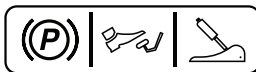

For your safety, park your vehicle in a safe place and engage the parking brake when you make any setup which requires extended time.

## Streaming









### Audio Streaming

Before you can stream audio from your mobile device to this unit, make sure Bluetooth connection is made.

1. From the home menu, touch .

The music from the device plays automatically.

### Playback Control

- To play or pause, touch  or .
- To skip to the previous or next track, touch  / .
- To search fast backward or forward, touch and hold  / .
- To select a repeat mode, touch .
- To turn on or off shuffle play, touch .
- To select a preset sound mode, touch .

### IMPORTANT NOTE

For best performance, your mobile device volume should be set to maximum.

All volume adjustment should be controlled from the unit.

# Bluetooth

## Hands-free Call

### Make a Call

From the home menu, touch .

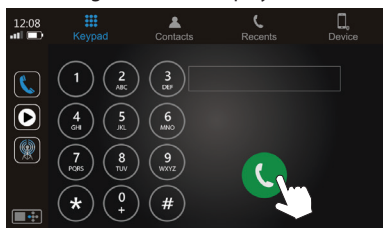

The calling interface is displayed.



### 3 Options to Dial a Bluetooth Call

- Input a phone number on the virtual keypad, and touch .
- Touch [Contacts] tab to access your contact list, then touch a contact.
- Touch [Recents] tab to access your call history, then touch a number.

### Operation During a Call

- To end a call, touch .
- To mute a call, touch .

## Voice Assistant (Push-To-Talk)

### View Connection Status

Touch [Device] tab to display the paired devices.

- A check mark indicates the currently connected device.
- To connect a paired device, simply touch the paired device name.
- To delete a paired device from the memory, touch .



### Voice Assistant (Push-To-Talk)

You can access smartphone voice assistant through the unit.

#### Before you Start

- Enable Bluetooth connection between your smartphone and the unit, or enable Apple CarPlay/Android Auto.
- Make sure the hands-free microphone is connected to the Microphone Input of the unit for audio input. (P.33)

Press  on the unit's front panel to activate voice assistant, then speak your command.

- To use a keypad during a call, touch .
- To switch to private mode, touch . The call will move to your mobile device.
- To return to hands-free mode, touch . The call will move back to the unit.

### Sync Phonebook and History

Touch [Contacts] or [Recents] tab, then [Download].

The phonebook and call history from your mobile phone will be displayed on the unit.

### Search a Contact

Touch [Contacts] tab, then [Search]. The alphanumeric keypad is displayed. Enter a contact name for search.

### Browse Call History

Touch [Recents] tab to display the call history.

Outgoing call



Incoming call



Missed call



# USB

## USB Playback

You can play audio, video and photos stored on a USB flash drive. Make sure your USB flash drive is connected to the front USB-C port or rear USB-A port.

From the home menu, touch .

Music from the device plays automatically.

If there are audio, video and photo files in the USB, audio files will play first.

### Audio/Video/Photo Play Switching

1. In the playback interface, touch . The file browser bar is displayed.



2. Touch [Music], [Video], or [Image] tab to select an audio, video or picture file to play.





#### IMPORTANT NOTE

Video and photo cannot not be viewed while driving. The vehicle must be stationary and the parking brake applied to enable viewing.

To activate viewing, also make sure the parking brake switch wire (Light green) is properly connected to your vehicle. (P.30)

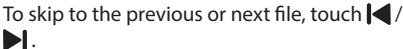
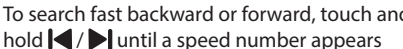

### Audio Playback

In the audio playback interface, playback control is displayed.

- To play or pause, touch .
- To skip to the previous or next file, touch .
- To search fast backward or forward, touch and hold  until a speed number appears then touch repeatedly to select a search speed.
- To select a repeat mode, touch .
- To turn on or off shuffle play, touch .
- To search for a file, touch  then enter a number on the virtual numeric keypad.

### Video Playback

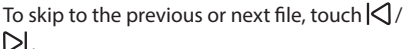
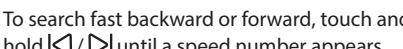
In the video playback interface, touch the screen to display playback control.





- To play or pause, touch .
- To skip to the previous or next file, touch .
- To search fast backward or forward, touch and hold  until a speed number appears then touch repeatedly to select a search speed.
- To select a repeat mode, touch .

### Video Settings

During video playback, touch  to access the Brightness / Contrast / Color settings.

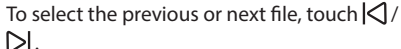
### Photo Playback

In the photo playback interface, touch the screen to display playback control.

- To play or pause, touch .
- To select the previous or next file, touch .
- To select a repeat mode, touch .
- To enlarge the picture, touch  then drag the magnifying slider.
- To rotate the picture, touch .

#### WARNING

Watching video or photo while driving is against Federal, State, and Local laws.

Do not use features of this unit if it cannot be operated safely and legally in your location.



# Other External Devices

## Audio/Video Input

### Playback

From the home menu, touch  .

Audio and video input screen is displayed.

### Audio Input

You can listen to an audio device (e.g. a mobile phone or MP3 player) through this unit.

### Audio Cable Connection

Connect the RCA inputs ("L-IN" and "R-IN") on the unit's back to the audio output on your device. (P.31)

If your device does not have an RCA, use the following audio cable (not included).

- For a device with 3.5mm headphone jack, use a 3.5mm to RCA audio cable.
- For a device with USB-C port, use a USB-C to RCA audio cable.

### Video Input

You can play video from a playback device (e.g. a CD/DVD, etc.).

### AV Cable Connection

Using audio/video cables (not included), connect the RCA inputs ("L-IN", "R-IN" and "V-IN") on the unit's back to the RCA outputs (yellow/white/red) on your playback device. (P.31)

#### IMPORTANT NOTE

Use the controls on the external device for playback control.

Video and photo cannot not be viewed while driving. The vehicle must be stationary and the parking brake applied to enable viewing.

To activate viewing, also make sure the parking brake switch wire (Light green) is properly connected to your vehicle. (P.30)

#### WARNING

Never rely solely on the backup camera; always check your surroundings before backing up.



Images may appear reversed if your camera is not properly installed or set up.

Do not use features of this unit if it cannot be operated safely and legally in your location.

## Camera

Make sure front/rear camera connection is correctly made. (P.33)

### Manual Camera Trigger

From the home menu, touch the rear camera icon () or the front camera icon () to display the camera view.

**Note:** If the camera icon is grayed out, enable the camera input. From the home menu, touch [SETTINGS] > [Camera].

On the camera view screen, touch the camera icon to switch between front and rear camera view.

### Automatic Camera Trigger

When the vehicle is put into reverse gear, the rear camera view will turn on automatically. The front camera view is not accessible when reversing.

#### IMPORTANT NOTE

For automatic rear camera trigger, make sure the purple/white wire (labeled "REVERSE") is connected to the reverse light. (P.28)

# Sound Settings

## Set Sound Effects

From the home menu, touch [SETTINGS] > [Audio] > [EQ] to access sound settings.

## Sound Mode and Equalizer Setting

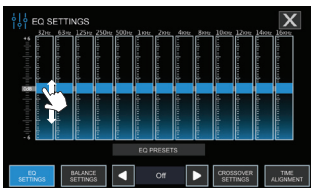

To select a preset sound mode (Jazz, HipHop, Pop, Rock or R&B), touch ◀ or ▶.

To customize equalizer setting, touch ◀ or ▶ until [Custom] appears then swipe up or down each frequency bar to adjust decibel output.

## Volume Balance Setting

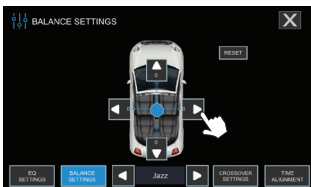

Touch ▲ or ▼ to adjust front and rear volume balance until the sound has a satisfying depth.

Touch ◀ or ▶ to adjust right and left volume balance until you are pleased with the sound and a suitable balance is found.

## Crossover Frequency Setting



[HIGH PASS]: Adjust High Pass Filter (HPF) for main audio (radio and media play). Only the frequencies above the one you set will be received to reproduce sound.

[LOW PASS]: Adjust Low Pass Filter (LPF) for main audio (radio and media play). Only the frequencies below the one you set will be received to reproduce sound.

[HPF SLOPE]: Set a high pass filter slope in decibels. An HPF slope determines the rate that attenuates the frequencies below the set one.

[LPF SLOPE]: Set a low pass filter slope in decibels. A LPF slope determines the rate that attenuates the frequencies above the set one.

[SUB Filter]: Adjust the cutoff frequency for the subwoofer. Only the frequencies below the one you set will be received to reproduce sound.

[SUB Level]: Adjust volume output for the subwoofer.

## Time Alignment Setting

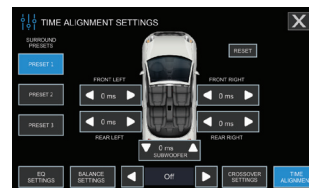

Adjust sound delay time so that sound from all the speakers arrives at the listener simultaneously.

1. Touch a preset button for settings as a listening position. Total three presets can be stored as different listening positions.
2. Touch ◀ or ▶ to set delay time for front and rear speakers, and touch ▲ or ▼ for the subwoofer.

Experiment with different time values to find the optimal settings for you.

To clear the set values, touch [RESET].

# System Settings

## General Settings

From the home menu, touch [SETTINGS] > [General] to access general settings.

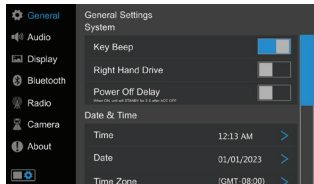

### System Tone and Shutdown Delay

[Key Beep]: Enable or disable touch sound.

[Right Hand Drive]: Change the Apple CarPlay menu bar from the left side to the right side of the screen and vice versa. Restart your vehicle to make the change effective.

[Power Off Delay]: Enable to keep the unit on for three seconds after accessory power or vehicle is turned off.

Enable shutdown delay if the unit restarts during vehicle's crank to start.

### Set Date and Time Manually

[Time]: Touch to access time setting screen. Swipe the time field up and down to set hours, minutes, and 12/24 hour format respectively.

[Date]: Touch to access date setting screen. Swipe the date field up and down to set year, month, and day respectively.

[Time Zone]: Select a time zone in your current location.

[Daylight Savings Time]: Enable to adjust Daylight Saving automatically.

### Set Date and Time Automatically

[Projection Clock Sync]: Enable to automatically set date and time from Apple CarPlay.

[Set Automatically by RDS/RBDS]: Enable to set date and time from RDS/RBDS radio broadcast.

### Language Setting

Select English or Spanish as menu language.

### Steering Wheel Control Retention

The unit allows you to retain your steering wheel controls (SWC), via A) connection to a steering wheel interface/adaptor (not included) or B) directly to your steering wheel control harness if compatible with the SWC Learning Setup. (P.28)

[SWC Fixed Settings]: Select this option if your vehicle needs a steering wheel interface/adaptor (not included). (P.28)

Follow the instructions of your steering wheel interface/adaptor to program the unit's audio and video functions on your steering wheel controls.

[SWC Learning Setup]: Select this option to access function programming if your vehicle does not need a steering wheel interface/adaptor for SWC connection. (P.28)



1. Touch [Reset] to enable programming mode.
2. Touch a function from the mapping chart, then hold down a button on the steering wheel to set the function.  
If programming fails, touch ◀ or ▶ to try low, mid or high resistance options for programming success.
3. Repeat Step 2 to program the other functions. After all mappings complete, touch [Confirm].

#### **IMPORTANT NOTE**

The mapping tool with resistance options is not compatible with all vehicles. If programming fails after trying low and high resistance options, your vehicle needs a steering wheel interface/adaptor (not included) for SWC retention.

# System Settings

## Audio Settings

From the home menu, touch [SETTINGS] > [Audio] to access audio settings.

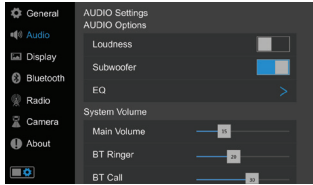

### Loudness and Sound Effect Setting

**[Loudness]:** Enable to boost output of low and high frequencies.

**[Subwoofer]:** Enable or disable subwoofer output.

**[EQ]:** Touch to access the following sound effects settings. (P.21)

- Sound Mode and Equalizer
- Volume Balance
- Crossover Frequency
- Time Alignment

### Startup Volume Setting

**[Main Volume]:** Set a desired volume for main audio (radio and media play) when the unit starts up with main audio.

1. Adjust the slider to set a new volume value.
2. Startup volume will be the set volume if the set volume is less than the last shutdown volume (as main audio).  
Startup volume will be the last shutdown volume if the set volume is greater than the last shutdown volume (as main audio).

### Initial Volume Setting for Other Sources

You can set desired initial volumes for the following sources.

- **[BT Ringer]:** Bluetooth ringtone volume.
- **[BT Call]:** Bluetooth call volume.
- **[Navi]:** Navigation volume.
- **[Voice]:** Voice assistant volume.

1. Adjust the respective slider to set a new volume value.

2. Initial volume will be the set volume if the set volume is less than the last used volume.  
Initial volume will be the last used volume if the set volume is greater than the last used volume.

### Customization of a Source Volume

You can increase or decrease one of the following source volumes, without affecting volume of other sources:

- **[Radio]:** Adjust radio volume alone.
- **[USB]:** Adjust USB playback volume alone.
- **[BT Audio]:** Adjust Bluetooth streaming volume alone.
- **[AV IN]:** Adjust audio input volume alone.
- **[Apple CarPlay]:** Adjust CarPlay volume alone.
- **[Android Auto]:** Adjust Android Auto volume alone.

# System Settings

## Display Settings

From the home menu, touch [SETTINGS] > [Display] to access display settings.

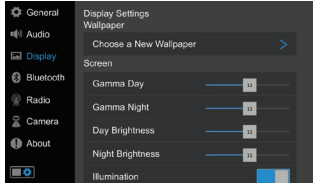

### Wallpaper Setting

[Choose a New Wallpaper]: Change a wallpaper for home, radio, or media playback screen.

### Screen Setting

[Gamma Day]: Change the differences between dark and light area. Applicable when your vehicle light is turned off.

[Gamma Night]: Change the differences between dark and light area. Applicable when your vehicle light is turned on.

[Day Brightness]: Adjust screen brightness. Applicable when your vehicle light is turned off.

[Night Brightness]: Adjust screen brightness. Applicable when your vehicle light is turned on.

## Bluetooth Settings

Make sure CarPlay or Android Auto is not connected to enable unit's Bluetooth.

From the home menu, touch [SETTINGS] > [Bluetooth] to access Bluetooth settings.

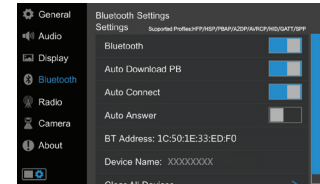

[Bluetooth]: Enable or disable Bluetooth function.

[Auto Download PB]: Enable to download the phonebook from the connected mobile phone.

[Auto Connect]: Enable to automatically connect the paired Bluetooth device.

[Auto Answer]: Enable to automatically answer an incoming call.

[BT Address]: Show the unit's Bluetooth address.

[Device Name]: Show the unit's Bluetooth name.

[Clear All Devices]: Clear all the paired Bluetooth devices from the unit's memory.

### Automatic Dimming Control

[Auto Dimming Control]: When enabled and the vehicle light is turned on, the screen brightness and panel button lights will automatically dim.

#### IMPORTANT NOTE

To enable night detection and auto dimming, make sure the orange/white wire (labeled "DIMMER INPUT") is connected to your vehicle's parking light. (P.28)

### Panel Button Light Setting

[Preset Color]: Select one of six colors for panel button lights. Make sure [Animation Effect] option is disabled to make the feature active.

[Animation Effect]: Enable to automatically cycle the panel button lights through six different colors.

# System Settings

## Radio Settings

From the home menu, touch [SETTINGS] > [Radio] to access radio settings.

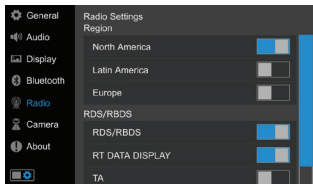

### Radio Region Selecting

Select a radio region where your unit is in.

**[North America]:** Enable if you are in this area.  
Tuner spacing: FM (200 kHz), AM (10 kHz)

**[Latin America]:** Enable if you are in this area.  
Tuner spacing: FM (100 kHz), AM (10 kHz)

**[Europe]:** Enable if you are in this area.  
Tuner spacing: FM (50 kHz), AM (9 kHz)

### RDS/RBDS Activation

**[RDS/RBDS]:** Enable or disable RDS/RBDS function.

When disabled, the unit will not receive RDS/RBDS service carried by FM radio signals.

### RDS/RBDS Information Display

**[RT DATA DISPLAY]:** Enable or disable a service that allows FM stations to display additional information (i.e. station name, program type or other dynamic/static message).



Not all FM stations will have or display RDS/RBDS information.

### RDS/RBDS Traffic Announcement

**[TA]:** When enabled, the unit will automatically tune in to traffic information broadcast despite the media source you are currently in.

Once the traffic announcement ends, the original source will automatically resume.

### RDS/RBDS Alternative Frequency

**[AF]:** When enabled, the unit will automatically locate the same tuning program on other stations and select the strongest signal of those being broadcast.

This feature is most useful on long trips when your car goes out of the range of a radio station.

## Camera Settings

From the home menu, touch [SETTINGS] > [Camera] to access camera settings.

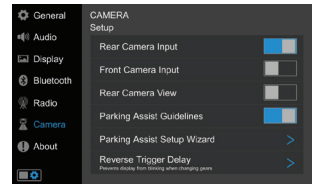

### Camera Trigger Control

**[Rear Camera Input]:** Enable or disable rear camera signal input.

**[Front Camera Input]:** Enable or disable front camera signal input.

**[Rear Camera View]:** When enabled, the rear camera view will be laterally (left/right) inverted.

**[Reverse Trigger Delay]:** Delay trigger of rear camera view by a set time. A proper time setting prevents the unit's screen from blinking when shifting gears.



For automatic rear camera trigger, make sure the purple/white wire (labeled "REVERSE") is connected to the reverse light. (P.28)

# System Settings

## Camera Settings

### Parking Assist Guidelines Setting

**[Parking Assist Guidelines]:** Disable the parking assist guidelines built in the unit if your rear camera view has its own parking assist guides.

**[Parking Assist Setup Wizard]:** Adjust the parking assist guidelines built in the unit.



Touch and drag a square icon to reposition the related guideline. Repeatedly touch an arrow icon to fine tune positioning of the related guideline. Touch **[OK]** to confirm the adjustment.

To reset to the default positioning of the guideline, touch **[Reset]**.

## System Information

From the home menu, touch **[SETTINGS]** > **[About]** to access system information.

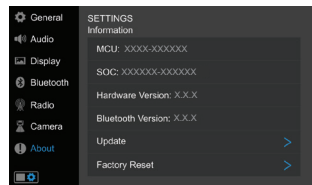

### Firmware Version Information

Version information starts with **MCU**, **SOC**, **Hardware Version**, or **Bluetooth Version**.

### Firmware Update

We continually try to improve our product. The product can be updated if needed.

**[Update]:** Touch to prompt firmware update.

Make sure a USB flash drive with a newer firmware is connected to the unit's rear USB port (not the front USB-C port). The firmware file must be saved in the root directory of the USB flash drive. Unzip the file and make sure the file name shows "BIN" extension after zipping.

### Resetting the Unit

**[Factory Reset]:** Reset the unit to the factory settings.



Reset the unit only when the unit fails to function normally. All your settings will be erased after resetting.

# Unit Installation

## Dash Mounting

### WARNING

See the section "Installation Warnings". (P.4)

### IMPORTANT NOTE

Before you mount the unit into the dash, complete the wiring connection (P. 28 to 34).

## Installation Dimensions

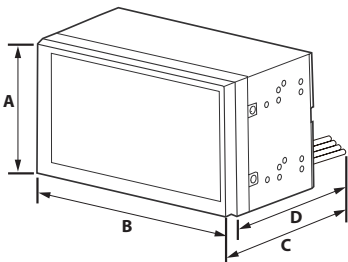

**A:** 3.80" (96.5 mm)    **B:** 6.71" (170.5 mm)

**C** (Overall depth): 4.78" (121.5 mm)

**D** (Installation depth): 4.57" (116 mm)

## Double DIN Opening Installation

This unit is designed to be installed in the double DIN dash opening (4" x 7").

1. Attach the two supplied L-brackets to the both sides of the unit, using the supplied bolts and the screw holes on both sides of the unit.

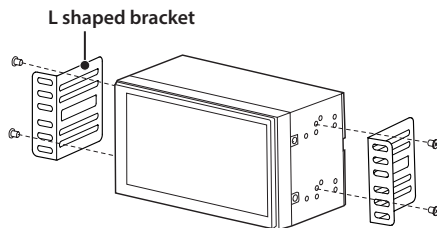

2. Slide the unit into the dash opening. Then fix the unit by fastening the L-brackets around the dash opening with proper screws (not included).

Consult a professional installer on whether screw hole drilling is required.

## Attach the Trim Ring

After the unit is mounted into the dash, attach the trim ring to the unit's front panel.

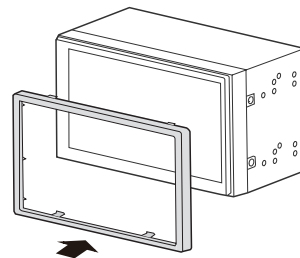



# Connections

## Power and Steering Wheel Control (SWC) Input Wiring

### WARNING

See the section "Installation Warnings". (P.4)

### IMPORTANT NOTE

Unused input/output wires need to be insulated with tape, heat shrink, or crimp connectors. **Never use wire nuts.**

Always replace the faulty fuse with the same type and rating (15A).

"DIMMER INPUT" wire (Orange/white) must be connected to the parking light for night detection and auto dimming in screen and panel button lights.

"REVERSE" wire (Purple/white) must be connected to the reverse light wire for automatic rear camera trigger when the gear is changed to reverse.

\* Power output is max. 500mA, 12V. It is recommended to use a relay if additional power is required.

\*\* Consult a professional installer for a correct steering wheel interface/adapter to match your vehicle, and follow the instructions of the steering wheel interface/adapter for complete wiring.

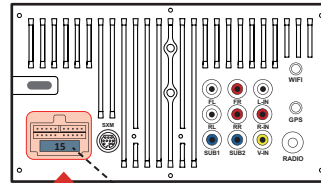

15A ATO Fuse

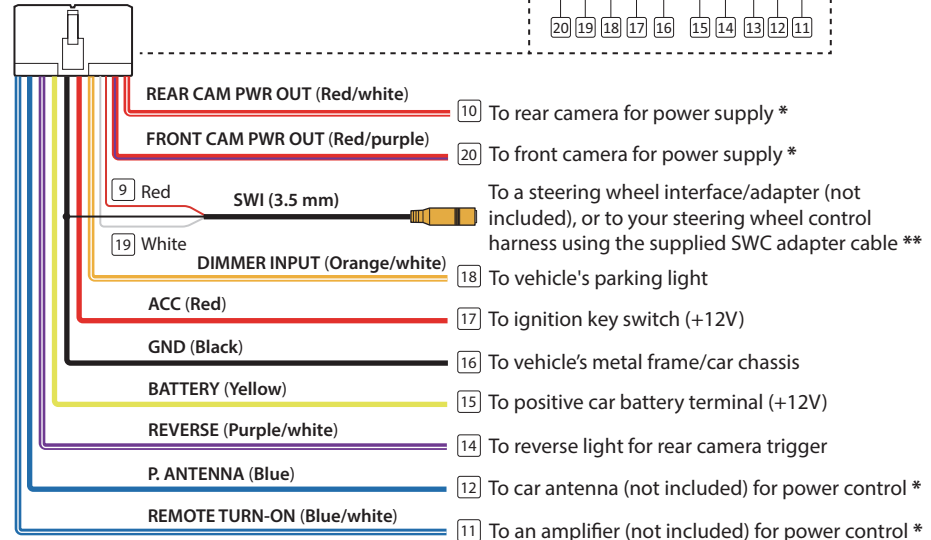
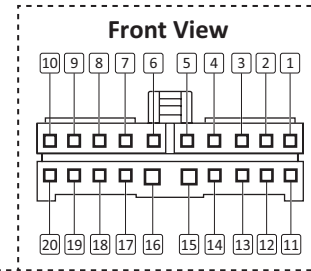

# Connections

## Speaker Wiring

### CAUTION

- Do not chassis ground any speaker wire leads.
- Only use 4-8  $\Omega$  speakers.
- DO NOT** use 1-3  $\Omega$  speakers.
- Do not bridge any of the channels. They are only to be wired in stereo mode.

### IMPORTANT NOTE

- Unused speaker wires need to be insulated with tape, heat shrink, or crimp connectors to avoid damage to the unit. **Never use wire nuts.**
- Double check speaker polarity when making connections.

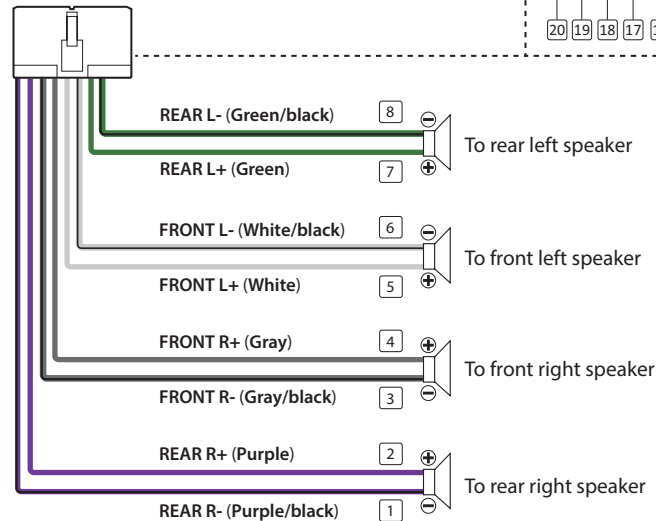
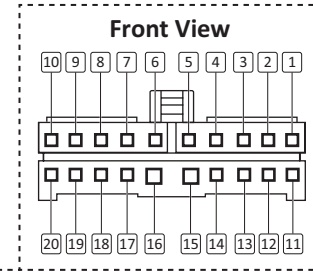
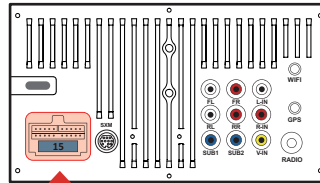



# Connections

## SiriusXM/Wireless/GPS

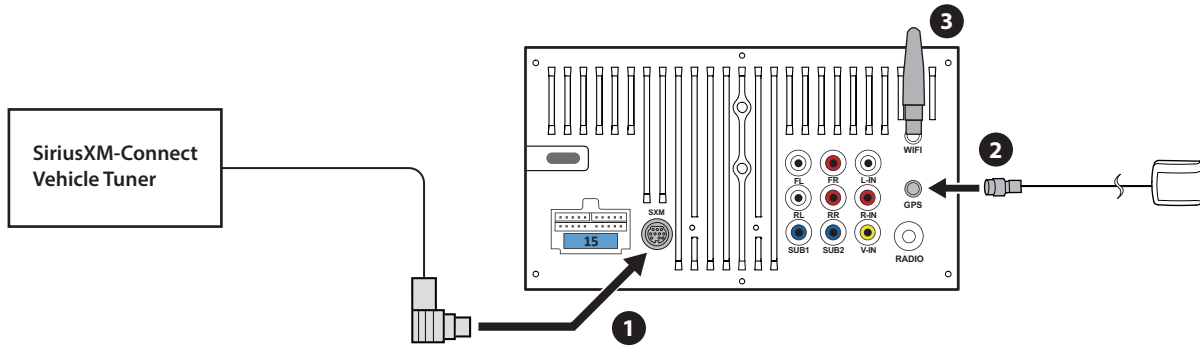

- 1 Connect a SiriusXM-Connect Vehicle Tuner (not included) before you can activate and receive satellite radio. For more information on how to install the SiriusXM Vehicle Tuner, consult the SiriusXM Vehicle Tuner Installation Guide.

- 2 Tighten the supplied GPS antenna to avoid connection failure.
- 3 The Wi-Fi/Bluetooth antenna is pre-attached and used to ensure wireless connection of CarPlay/Android Auto.

### Important!

Make sure the Wi-Fi/Bluetooth antenna is tightened to avoid wireless connection failure.

# Connections

## AV/Radio

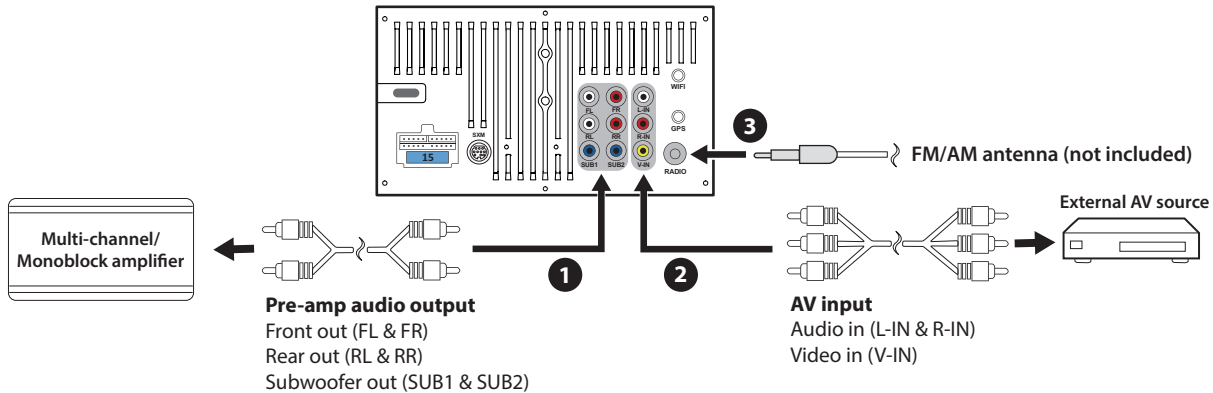

### **i** IMPORTANT NOTE

Subwoofer pre-amp is a non-fading mono output.

Always run signal wires away from power cables to reduce the possibility of noise.

**1** Using RCA audio cables (not included), connect the audio output on the unit to an external amplifier (not included).

**2** Using RCA audio cables (not included), connect the audio input ("L-IN" and "R-IN") on the unit to the audio output on an external AV source.  
Or using an RCA to 3.5mm/USB-C/lightning adapter (not included), connect the audio input ("L-IN" and "R-IN") to the audio output on your mobile phone.

Using a yellow RCA cable (not included), connect the video input ("V-IN") on the unit to the video output on an external AV source.

**3** Connect an FM/AM antenna (not included) for better radio reception.

# Connections

## Mic/Camera/CarPlay/Android Auto

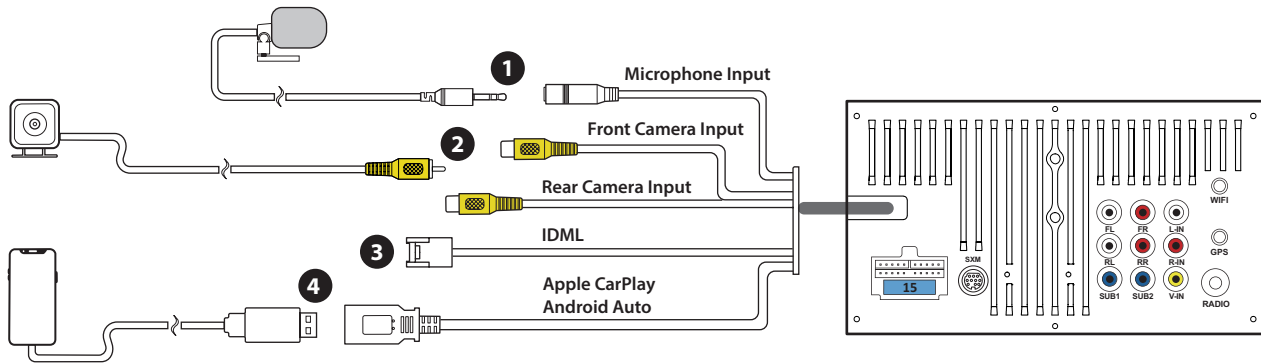

**1** Connect the 3.5mm plug of the supplied hands-free microphone for sound input when using phone call or voice assistance through Bluetooth or CarPlay/Android Auto.

**2** Connect the RCA plug of your camera for video signal input.  
To operate your rear camera, you also need to connect camera power and reverse signal. (P.28)

**3** Connect Maestro iDataLink interface (not included) to use factory features (e.g. steering wheel audio controls and other factory conveniences).

**Note:**  
This port is currently non-functional, and will be enabled via software update.

**4** Connect the lightning cable or USB cable of your iPhone or Android device to enable use of CarPlay or Android Auto.

You may also connect a USB flash drive for media playback.



Never rely solely on the backup camera. Always check your surroundings before backing up.

Images may appear reversed if your camera is not properly installed or set up.

Do not use features of this unit if it cannot be operated safely and legally in your location.

# Connections

## Hands-Free Mic Installation

### Placement

The unit comes with a hands-free microphone with sticky base and 10ft wire.

The location of the microphone can vary from different vehicles due to layout, interior materials, etc.

The **Red** shaded areas are the recommended locations for best microphone performance.

Items to look for before placement:

- Do not place in front of air vents.
- If the vehicle has tweeters placed on sail panel, do **NOT** locate the microphone on steering column area.
- The front of the microphone must not be blocked.
- Microphone should be firmly attached to mounting location.
- Do not cover the grille openings surrounding the microphone.
- To avoid excessive wind noise, do not place near the sunroof opening.

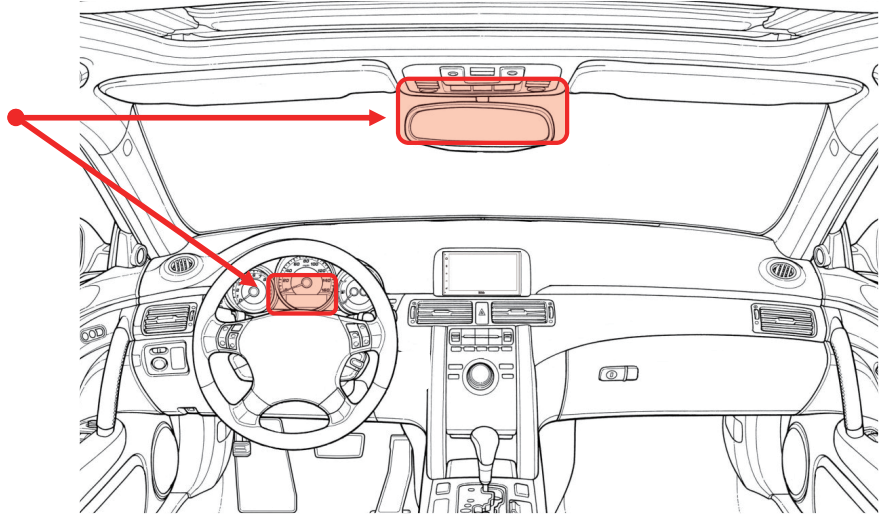

### Attach the Microphone

1. Clean the mounting surface.
2. Remove the backing paper from the microphone base, then stick the base onto the mounting surface.
3. Route and secure the microphone wire properly.



#### WARNING

Run the microphone wire where it will **NOT** impede with the operation of any safety items (e.g. airbags, knee airbags, etc.)

# Troubleshooting

## Important!

If you have checked the points described in the list and the problem persists, turn off the vehicle for ten seconds then turn it back on again.

If the problem still persists after restarting the unit, reset the unit by using a small pin to press the reset button on the front panel.

If you still have problems after applying suggestions above, please contact our Customer Service for further assistance.

## General

### No response / Screen or unit not powered on / Bad or incorrect picture quality.

- Restart the unit by turning off the vehicle for ten seconds, then turning the vehicle back on.

### No sound from the unit.

- The unit is muted. Adjust the volume.
- Select the correct audio source on the unit.

## USB

### Cannot play a media file.

- The file format on the USB is not supported by the unit. Change media files.
- The file system of the USB is not supported by the unit. Change the USB.

### No video playback or picture display.

- Video or picture display is enabled only when the parking brake is engaged, and the parking brake input wire is connected to your vehicle. (P.30)

## Apple CarPlay/Android Auto

### Cannot start Apple CarPlay/Android Auto.

- Verify the pre-attached Wi-Fi/Bluetooth antenna is tightened. (P.31)
- CarPlay/Android Auto is disabled. Enable CarPlay (P.14) or Android Auto (P.16).
- For CarPlay, make sure CarPlay is enabled on your iPhone (**Settings** > **General** > **CarPlay** > **Paired device** > **Enable CarPlay**).
- Delete the paired device on both your phone and the unit. Make the connection again.

## Bluetooth

### Cannot stream via Bluetooth.

- Pair and connect your mobile phone. (P.17)
- Bluetooth connection is disabled. Enable Bluetooth connection. (P.17)
- Delete the paired device on both your phone and the unit. Make the connection again.

### Poor hands-free phone call quality.

- Check signal strength on your mobile phone.

- Check that the microphone is firmly attached and plugged in. Or relocate the microphone for noise reduction. (P.34)

### Cannot make Bluetooth connection.

- CarPlay/Android Auto connection disables Bluetooth connection. Enable Bluetooth connection. (P.17)
- The unit is already connected to a mobile device. Disconnect the current Bluetooth connection before connecting to another Bluetooth device.
- Delete the paired device on both your phone and the unit. Make the connection again.

## FM/AM Radio

### Poor radio reception.

- FM/AM antenna is not connected or extended. Connect and secure an FM/AM antenna (not included). (P.32)
- The antenna output wire is not connected. Connect the wire. (P.28)
- Turn off RDS/RBDS, TA and AF. (P.25)



# Troubleshooting

## SiriusXM Radio

### "Check Antenna" appears.

- Check that the antenna cable is connected to the SiriusXM-Connect Vehicle Tuner.
- Check the antenna cable for damage and kinks. Replace the antenna cable if damaged. SiriusXM products are available at your local car audio retailer or online at <https://shop.siriusxm.com/all-parts/>.

### "Check Tuner" appears.

- Check that SiriusXM-Connect Vehicle Tuner is securely connected to the unit (*P.31*), or the Tuner is damaged.

### "Subscription Updated" appears.

- Your subscription is updated. Press the appropriate button to clear the message.

### "Channel Unavailable" appears.

- The selected channel is not available. For more information about SiriusXM channel lineup, visit [www.siriusxm.com](http://www.siriusxm.com).

### "No Signal" appears.

- Verify that your vehicle is outdoors with a clear view of the sky.
- Verify that the SiriusXM magnetic base antenna is mounted on a metal surface on the outside of the vehicle.
- Move the SiriusXM antenna away from any obstructions.
- Check the antenna cable for damage and kinks.
- Consult the SiriusXM-Connect Vehicle Tuner installation manual for more information on antenna installation.

### "Channel Unsubscribed" appears.

- The selected channel is not subscribed.  
If you have questions about your subscription package or would like to subscribe to this channel, in the USA, visit [www.siriusxm.com](http://www.siriusxm.com) or call 1-866-635-2349; in Canada, visit [www.siriusxm.ca/activate](http://www.siriusxm.ca/activate) or call 1-888-539-7474.

### "Channel Locked" appears.

- The selected channel is locked by the Parental Control feature. Enter the correct password to unlock. (*P.13*)

# Specifications

## General

Input voltage.....	8.5 – 18 VDC
	14.4 VDC (Nominal)
Current consumption .....	Max. 15 A
Fuse .....	15 A (ATO, blade)
Dimensions (H x W x D).....	3.80" x 6.71" x 4.57"
	(installation depth)
Unit weight.....	1.73 lbs.
Operational temperature .....	-4 – 140°F

## Display

Screen size .....	7"
Aspect ration.....	16:9
Resolution .....	1024 x 600
Screen type.....	TFT-LED Active Matrix

## Audio

Max power .....	.85 W x 4
Speaker impedance.....	4 – 8 Ω
Preset EQ.....	Jazz, HipHop, Pop, Rock, R&B
EQ bands (Adjustable).....	32/63/125/250/500 Hz
	1/2/4/8/10/12/14/16 kHz
EQ boost/cut .....	±6 dB
High pass filter (HPF).....	20/60/80/160/250 Hz
Low pass filter (LPF).....	2/8/10/16/20 kHz
HPF/LPF slope.....	-6/-12/-18 dB

Sub filter.....	50/80/120/160 Hz
Sub level .....	+1 to +14 dB
Pre-amp output.....	2x Front (4V, full range)
	2x Rear (4V, full range)
	2x Sub (mono, 4V, LPF)
Audio input.....	2x RCA, 1 Vp-p/75 Ω

## Video

Signal system .....	NTSC/PAL
Video input (RCA).....	1x RCA, 1 Vp-p/75 Ω

## Radio

Frequency range.....	87.5 – 108 MHz (FM)
	522 – 1710 kHz (AM)
Frequency step (FM).....	200 kHz (USA)
	100 kHz (Latam)
	50 kHz (Europe)
RDS/RBDS.....	RT data , TA, AF

## Apple CarPlay

Device support .....	iPhone 5 or later
iOS.....	iOS 7.1 or later

## Android Auto

Wired.....	Android 6.0 or later
Wireless .....	Android 11.0 or later

## USB

Front USB port .....	USB-C
	Media/Charging (1.5A)
Rear USB port.....	USB-A (2.0, High Speed)
	CarPlay/Android Auto
	Charging (1.5A)
Supported USB device.....	Max. 32GB
File system.....	FAT32
Audio playback.....	MP3, WMA, WAV,
	FLAC (192kHz/24bit)
Video playback .....	AVI, MKV, WMV
Picture playback.....	JPG, PNG, BMP

**Note:** Not all listed media files are guaranteed to play due to different creation methods or file contents.

## Bluetooth

Bluetooth version.....	V5.2 + EDR
Transmission range.....	33ft/10m (line of sight)
Bluetooth profiles.....	A2DP, AVRCP, HFP,
	PBAP, HSP, HID, GATT, SPP

## Wi-Fi

Frequency band.....	5 GHz
(Only used in wireless connection for CarPlay/ Android Auto)	

*Specifications are subject to change without notice.*



BOSS Audio Systems  
3451 Lunar Court • Oxnard, CA 93030  
[www.bossaudio.com](http://www.bossaudio.com)  
**805-751-4853 Customer Service**  
**Tech Support: [www.bossaudio.com/support](http://www.bossaudio.com/support)**



**0324**  
**V:1L**

iPhone® is a trademark of Apple Inc., registered in the U.S. and other countries. Apple CarPlay is a trademark of Apple Inc. BOSS Audio Systems is not affiliated with Apple Inc.

The Bluetooth® word mark and logos are registered trademarks owned by Bluetooth SIG, Inc. and any use of such marks by BOSS Audio Systems is under license. Other trademarks and trade names are those of their respective owners.

Android Auto is a trademark of Google LLC.

Use of the Apple CarPlay logo means that this user interface meets Apple performance standards. Apple is not responsible for the operation of this device or its compliance with safety and regulatory standards. Please note that the use of this product with iPhone may affect wireless performance.

SiriusXM-Ready and all related marks and logos are trademarks of Sirius XM Radio, Inc. All rights reserved. SiriusXM-Ready allows you to listen to ad-free music, plus all the sports, talk, comedy, news coverage, and all in one place. (SiriusXM Connect Tuner and Subscription required. Sold Separately.)

**BOSS**<sup>®</sup>  
AUDIO SYSTEMS  
**ELITE**

## **ELPC40B USER MANUAL**

**REAR OR FRONT VIEW LICENSE  
PLATE MOUNT CAMERA**

FEATURING WIDE ANGLE VIEW,  
HIGH RESOLUTION COLOR,  
WATERPROOF, AND DISCREET  
MOUNTING BRACKET





## **Introduction**

This camera is designed for use as a front view or rear facing back up camera. Conveniently mounted behind your license plate while hiding the mounting bracket. When installed with any of our camera-capable head units, the camera feed may be automatically triggered by shifting into reverse or manually selected from the home screen.

## **Package Contents**

- 1x Camera with mounting solution and power/video female connector
- 1x Power/Video cable with male (yellow) RCA and male bullet terminal
- User manual

## **Important**

The User Manual should be read prior to installation and use of the product. Failure to read User Manual could result in injury, and/or damage to the product. This could potentially void the warranty.

### **Important safety precautions**

- Use of this camera should be in addition to standard safe driving practices. Always check your surroundings and use your mirrors when backing up.
- Always remember there may be obstacles out of the display area of the camera. Certain obstacles may not be easily detected or seen by the camera alone.

### **Installation precautions**

- **WARNING:** Always consult a professional installer.
- Improper wiring and mounting of the camera can cause damage, injury or accident. Contact our technical support for any installation questions.
- Disconnect the negative terminal of the vehicle battery prior to wiring.
- When making modifications to your car due to the installation, make sure the safety and structural integrity of the car is not impaired.
- It is highly recommended to route and secure the camera's cable along factory wiring of the vehicle. Depending on your application this may be beneath the carpet, inside the headliner, interior panels or frame rails.



## Wiring

- Follow the steps described below to install this product as a front camera or a rear camera.
- For the rear camera view to automatically display on the head unit when reversing, ensure the **"REVERSE"** input trigger wire is connected to the vehicle's positive reverse light wire. If installed with a front camera, the front camera feed will not be accessible when reversing.
- Both rear and front camera view can be selected via Home screen options on your head unit.

1. Connect the video cable's yellow RCA plug to the **"Front Camera Input"** or **"Rear Camera Input"** signal input depending on the placement of the camera on the vehicle.

2. Connect the red wire from the power/video cable to your head unit's designated FRONT or REAR Camera power output wire. Use the appropriate camera output wire that matches the camera's placement on the vehicle.

3. Connect the black male connector of the power/video cable to the female connector on the camera for power and video connection.

When connecting, align the arrows on the connector bodies to ensure proper engagement.



4. Identify the vehicle's positive reverse light wire. Tap and extend it to the reverse input trigger of the head unit. This is only for rear view camera installation.

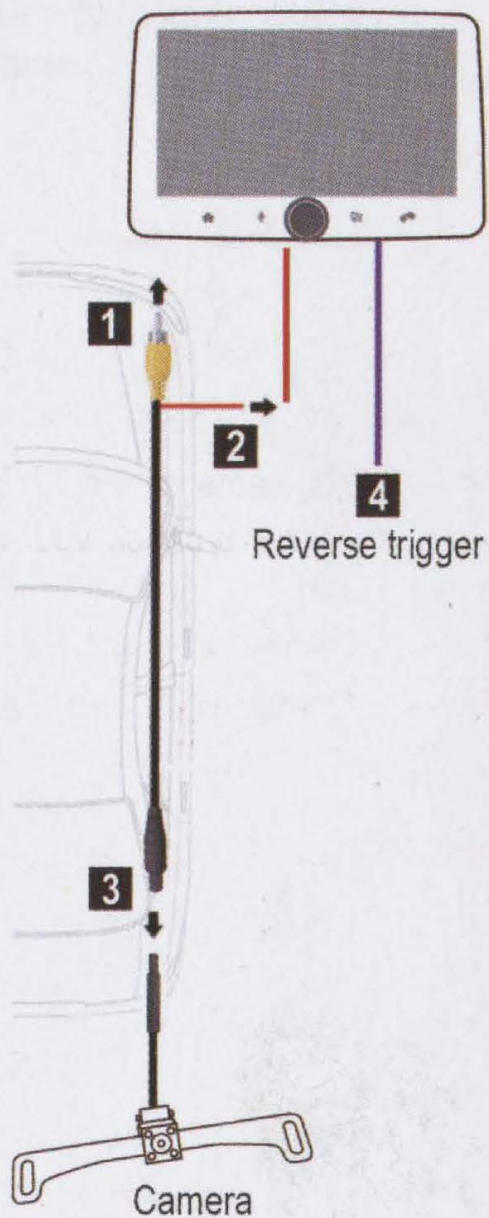



## Mounting

The camera is designed to be mounted behind the license plate of your vehicle. Line up the camera mount with the existing holes on the license plate. Drilling is not required for the camera mount.

1. Identify an opening near the license plate to route the wiring into the vehicle. Removing the license plate lamp or in some cases drilling a small hole may be required to route the cable into the vehicle.
2. Unfasten the license plate's screws. Align the camera mount with the two top license plate mounting holes. Refasten the camera and license plate assembly to the vehicle.

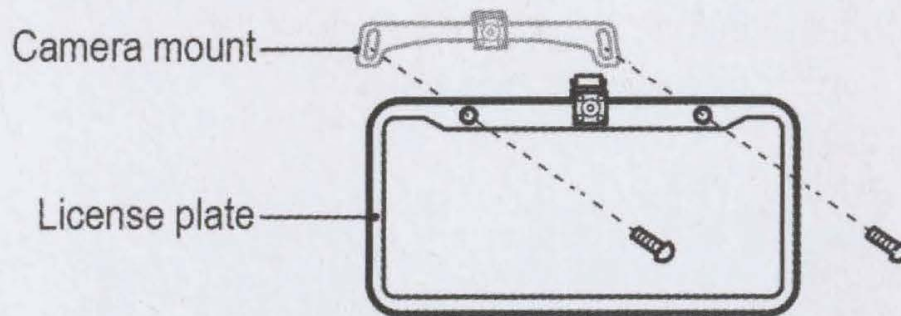

3. Verify the camera angle is properly positioned. If needed, loosen the screws and adjust the camera angle then refasten the screws.

## Troubleshooting

Problem	Solution
No image	Verify the camera's power cable is securely plugged. Verify there is correct and secure wiring between the camera and your head unit. Verify the reverse wire on your head unit is connected to the vehicle's reverse light. Verify correct camera settings on your head unit. Restart the camera.
Image blurry	Check for water drops or dust on the camera lens. Clean it with a damp, fiber-free cloth.
Image shaking	Verify the camera is tightly mounted.
Image slanted	Adjust the camera frame position.



## Image Setting Options

- The camera supports AHD (720p) and CVBS (480p) video format. If your monitor does not support AHD (unable to display images), cut open the green wire loop (labeled "AHD/CVBS Resolution") which splits from the camera's cable to switch the camera to CVBS format.
- To remove the on-screen parking guidelines, cut open the white wire loop which splits from the camera's cable. Otherwise, keep the white wire loop uncut.
- If the camera image appears reverse, cut open the blue wire loop which splits from the camera's cable. Otherwise, keep the blue wire loop uncut.

**Important:** If any cuts were made for the above 3 options, you must cycle the camera power to enable the new setting.

## Specifications

Power supply .....	12 VDC
Viewing angle .....	120° (AHD), 115° (CVBS)
TV system.....	NTSC
Video output .....	1.0 vp-p, 75 Ω
S/N ratio.....	≤45 dB
Ingress protection rating .....	IP68 (waterproof)
Operating conditions.....	-22 to +185°F (-40 to +85°C) Max. 95% RH
White balance .....	Auto
Illumination .....	Min. 0.1 lux
Automatic gain control (AGC).....	Auto
Resolution (TV lines) .....	720 (AHD), 480 (CVBS)
Electronic shutter speed.....	1/60 (NTSC)
Effective pixels.....	1280 x 720 (AHD), 648 x 488 (CVBS)
Dimensions (L x W x H) .....	7.756" x 0.88" x 0.88" (197 x 22 x 22 mm)
Cable length .....	236"/6m (power/video cable); 24"/0.6m (camera's cable)

*Specifications are subject to change without notice.*



**BOSS**<sup>®</sup>  
AUDIO SYSTEMS  
**ELITE**

BOSS Audio Systems  
3451 Lunar Court • Oxnard, CA 93030  
[www.bossaudio.com](http://www.bossaudio.com)  
**805-751-4853 Customer Service**  
Tech Support: [www.bossaudio.com/support](http://www.bossaudio.com/support)



0624