

G-ONQ

2CH QHD | QHD G-NET DASH CAM

USER MANUAL



GNET
GLOBAL NETWORK

CONTENTS

01. BEFORE USE

IMPORTANT SAFTY	01
INSTRUCTIONS WARNING	
CAUTION FOR MEMORY CARD	02
PRODUCT FEATURES	03
PACKAGE COMPONENTS	04
NAME OF EACH PART	05
SPECIFICATION	07
INSTALLATION	08

02. FUNCTION

HOW TO USE	17
MEMORY CARD VIDEO FOLDER	27

03. APPLICATION

BEFORE WI-FI CONNECTION	29
SMARTPHONE CONNECTION	30

04. withCLOUD

USING 「WITHCLOUD」	33
HOW TO USE 'WITHCLOUD'	34

05. PC VIEWER

PC VIEWER INSTALLATION	39
SCREEN GUIDE	42
QUESTION AND ANSWER	44
TROUBLE SHOOTING	60
WARRANTY CARD	65

IMPORTANT SAFETY INSTRUCTIONS WARNING

© 2022 GNET SYSTEM CO.,LTD. or its subsidiaries All rights reserved. Under the copyright laws, this manual may not be copied, in whole or in part, without the written consent of GNET SYSTEM CO.,LTD.

GNET SYSTEM CO.,LTD reserves the right to change or improve its products and to make changes in the content of this manual without obligation to notify any person or organization of such changes or improvements.

Go to www.gnetsystem.com, www.g-on-the-road.com for current updates and supplemental information concerning the use of this product. GNET+ and the GNET logo, are trademarks of GNET SYSTEM CO.,LTD. or its subsidiaries, registered in South Korea and other countries. GNET G-ON4™, are trademarks of GNET SYSTEM CO.,LTD. or its subsidiaries. These trademarks may not be used without the express permission of GNET. microSD- and the microSD logo are trademarks of SD-3C, LLC. WiFi+ is a registered mark of Wi-Fi Alliance Corporation.

-
- **Do not expose the unit to electrical shock or debris.**
 - This may cause product damage, fire, or electrical shock.
 - **Avoid use with excessive vehicle window tints or special auto glass.**
 - Images may be blurry or distorted and may cause interference with the reception rate of the GPS.
 - **Do not modify or dismantle the device/ accessories.**
 - We are not responsible for any damage to the device or vehicle due to user tampering.
 - **Never operate the device or adjust settings while driving.**
 - Always keep your eyes on the road.
 - **Do not use liquids or chemicals to clean the product or accessories.**
 - This may cause product damage, fire, or electrical shock.
 - **Please use a non-scratch lens cloth to clean the product and accessories.**
 - Routinely clean camera lens for best results.
 - **In the absence of the external GPS, the device's date and time may be reset.**
 - Please always check that the date/ time is correct.
 - **When parked for long periods of time in direct sunlight, a temperature increase inside the vehicle may result in a memory card corruption and/ or recognition error.**
 - It is recommended to remove the memory card and store it out of direct sunlight during long periods of vehicle inactivity.
 - **Avoid high temperature or high humidity environment for normal operation of the product.**
 - **Check the operation of the rear camera(s) periodically before driving.**
 - Only the front camera will be captured in the event of a malfunction or defect.

CAUTION

FOR MEMORY CARD

- Overtime, memory degradation can occur and should be replaced periodically.
- To prevent incompatibility problems, please use only a genuine GNET memory card. The GNET memory cards are specifically designed to operate with our GNET systems and are covered under our warranty program.
- When a vehicle accident occurred, it is recommended to remove the memory card from the device and save the data to a computer immediately. When the memory card is full, the data will be overwritten, and the accident data will be lost.
- Please be sure to remove the memory card only after the recording LED is off. Otherwise, if removed too early, video data could be lost or corrupted. This can also shorten the card's lifespan.
- Please do not interchange / swap the memory cards between other products. Data may be erased and lost if the memory card is automatically formatted.
- It is recommended that the memory card be formatted at least twice a month for product and lifespan maintenance. For best results, please use the official SD Formatter (www.sdcard.org).
- GNET System dash cameras can support memory card (SD) capacities ranging from 8GB to 1TB.
- When a new or used memory card is inserted into the device for the first time, the system will go into standby mode for 3 to 5 minutes. Please do not attempt to remove the memory card during standby mode or when the device is formatting the card.
- It is possible to format the memory card in the GNET application for Mac and PC. Please visit the GNET SYSTEM's website at:
<https://www.gnetsystem.com/eng> → SUPPORT → DOWNLOAD



SONY STARVIS
IMAGE SENSOR



CLOUD SYSTEM



2CH
QHD/QHD



LBP



H.265 CODEC



G-NET
Wi-Fi APP



REAL HDR



TIME LAPSE



SD LOCKS FOR
MEMORY PROTECTION



PARKING
MODE

PACKAGE COMPONENTS

01. BEFORE USE

• Basic Components (Embedded GPS)



Main camera



Rear camera



User manual



Wi-Fi dongle



Hardwire kit



Screw, Wrench



Rear camera connection cable



Micro SD memory card

• Optional Product



Cigarette lighter power cable



OBD power cable

! Cigarette lighter and OBD power cables are each sold separately.

※ The size and appearance of the components depicted above may be different from the real components.

※ Specifications and components may be changed without notice for quality assurance.

※ We highly recommend that a GNET Genuine Memory Card be used with all GNET products.

• Front Camera

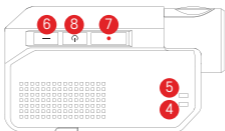
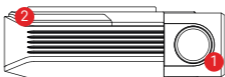
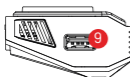
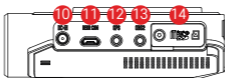

- | | | |
|------------------------|--------------------------------|------------------------------|
| ① Front camera lens | ⑥ Wi-Fi connection button | ⑪ Rear camera connector port |
| ② Security LED | ⑦ Manual recording button | ⑫ GPS connector port |
| ③ Front camera bracket | ⑧ Power button | ⑬ OBD2 connector port |
| ④ GPS LED | ⑨ Wi-Fi USB dongle port | ⑭ Micro SD card cover |
| ⑤ REC LED | ⑩ Power connector port (DC-IN) | |

• Rear Camera

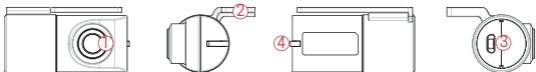

① Camera lens

② Rear cam mount

③ Rear cam connector port

④ Status LED

Image Sensor	SONY Starvis
Audio input	Built-in Microphone
Video Compression	H.265
Audio Compression	ADPCM
Resolution	Front : QHD (2560 X 1440), Rear : QHD (2560 X 1440)
Frame Rate	All cameras : Max. 60 FPS
Recording Time(Approx.)	32GB : 2hrs 50mins / 64GB : 5hrs 40mins / 128GB : 11hrs 20mins 256GB : 22hrs 40mins
3G/4G/Router (Optional)	Connect to withCLOUD via 3G/ 4G/ Router telecommunication
Wi-Fi (Optional)	Connect to GNET Smart phone application via Wi-fi dongle
G-Sensor	Event recording by External Shock
Speaker	Operation Status alarm / Voice guidance
External GPS	Synched with Google map, Keep track of location and Speed
Angle Of View	Front: 140°, Rear: 140°
Viewer	Windows XP/7/8/10, Mac, Support 32Bit / 64Bit, Synchronizing Google map with PC viewer is supported over Windows7 and explorer 10 as per Google' s policy.
Power	DC 12V - 24V
Allowable current of providing fuse	3A
Operation Temperature	-20°C ~ 60°C
Humidity	10-95%
Dimension (WxHxD, mm)	Front: 116x56x32, Rear: 44x38x28

※ Specifications and components are subject to change without notice for quality assurance.

- How to install Dash cam

- 1 Assemble the front camera with the provided bracket in the order displayed. Make sure bracket is hooked correctly. Push and align it until a sound is heard. (①,②).

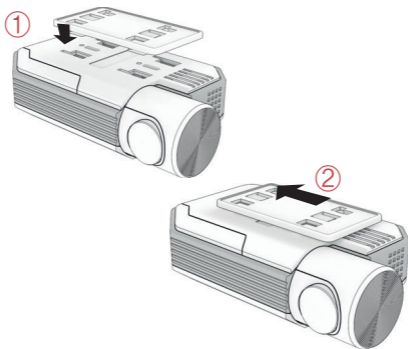

-
- 2 Once the bracket is secure, ensure that the memory card has been inserted. Proceed to peel the cover from the double sided tape on the bracket.

- 3 Install the front camera onto the front windshield of the vehicle making sure the angle and location is properly aligned.

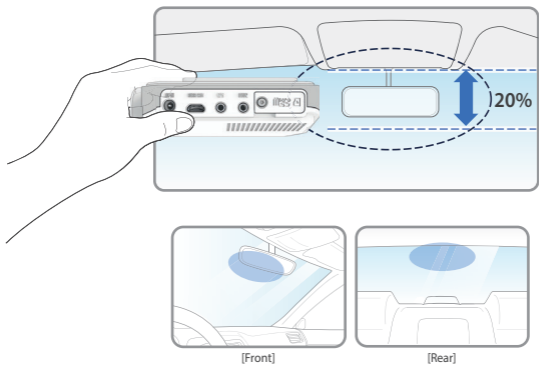

TIP: The adhesive is extremely sticky. Avoid touching the adhesive to the windshield until the mount is properly positioned and aligned.

- 4 Depending on the vehicle, the front angle may be different. It is recommend to hold a dash cam vertically based on a regular passenger car.

- Connect the power cable to the fuse box terminal inside the vehicle.
(The connected terminal should be one which is always supplied power even when ACC power is turned off, such as emergency lights and/ or door racks.)
Otherwise if using a cigar power cable, plug it directly into the vehicle cigar socket.

3-Wire Power Cable

- Connect VCC to current fuse at vehicle start-off
- Connect ACC to a fuse that does not flow when the vehicle is switched off
- Connect GND to ground on the vehicle's body

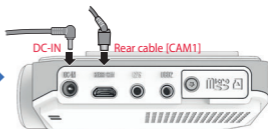
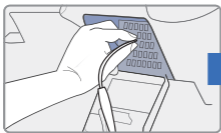

CAUTION

GNET strongly recommends having an experienced installer with the proper knowledge of electrical systems install the device. Incorrectly wiring the power cable can result in damage to the vehicle or the battery and can cause bodily injury.

- Connect the other side of the power cable to the DC-IN labeled port of the front camera.

- 7 Attach the rear camera to the rear windshield of the vehicle and connect the cable to the front camera.

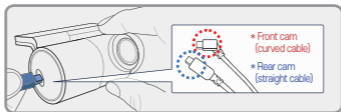
**WARNING**

When the cable is bent as shown in the picture, the data flow may be interrupted and a recording error may occur. Please be careful.

- 8 Carefully tuck the power cable and rear camera connection cable into the linings of the vehicle between the ceiling and glass.

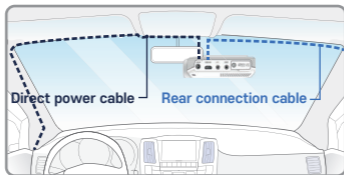
**CAUTION**

GNET strongly recommends having an experienced installer with the proper knowledge of electrical systems install the device. Incorrectly wiring the power cable can result in damage to the vehicle or the battery and can cause bodily injury.

• How to Install Fuse Cable

Please refer to the car manual because the fuse box is differ depending on car model.
It is recommended that install the power from the automobile shop.
We are not responsible for any damage caused by self-installation.

1 Find the Fuse box using electric tester from fuse box of the vehicle.

※ [VCC] (Yellow line) : When the car is off, it connects with fuse that current is flowing

※ [ACC] (Red line) : When the car is off, it connects with fuse that current does not flow

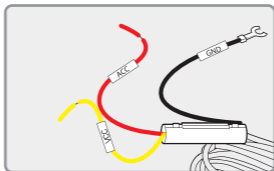

2 After connecting [VCC], [ACC] on vehicle fuse, put them into the Fuse box.

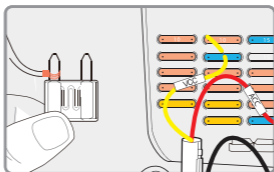

- 3 Connect [GND] line to vehicle
(Do not connect the volt which is connected to dash board. Current is not flowing)

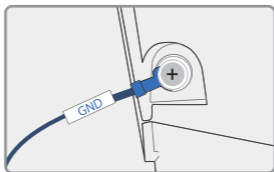

- 4 Connect the power cable to confirm the operation of product.
And organize cables to finish installation work

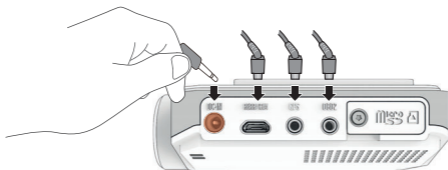

- Inserting the Memory Card

! Please be fully aware of the orientation of the Micro SD Memory Card.

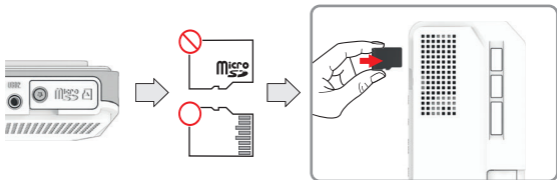

- Push the Micro SD Memory card into the memory card slot until you hear 'click' sound.
- When using memory card for the first time or when the memory card is reused after format, the system will be in stand-by mode for 3~5 minutes to create system files and checking the memory card.
- Recording starts with voice guidance saying "Start recording"

- SD Card Secure Cover

1 Open the SD card cover and insert the memory card.

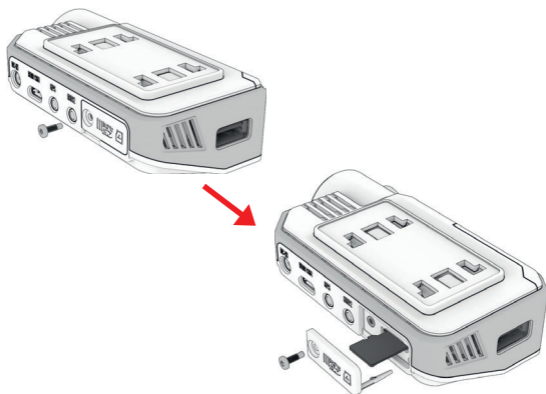

- SD Card Secure Cover

2 Then slide the SD cover into the hole as shown, and fasten the screw to the body.

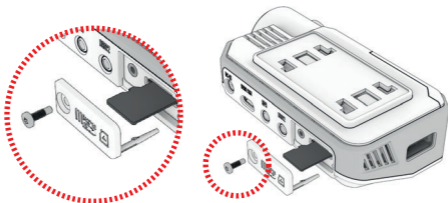

3 Covering the SD card is completed.

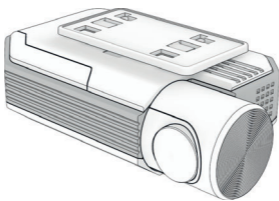

- Product Operation

POWER ON	<p>All LED will be turned on when the engine is on or power is on. [Start recording] starts along with voice guidance and REC LED is turned on. GPS LED will be turned off if it is not connected by GPS.</p>
POWER OFF	<p>All LEDs will be turned off when press the power button or the constant cable is disconnected.</p>
Wi-Fi ↔ CLOUD MODE CHANGE	<p>If you press the Wi-Fi button for 3~4 seconds, it changes from Wi-Fi mode to Cloud mode or from Cloud mode to Wi-Fi mode.</p>
Wi-Fi USER REGISTRATION	<p>If press the Wi-Fi button, the stand-by mode voice guidance will be displayed. If there is no connection for 2 minutes, it will be automatically discontinued. If press the Wi-Fi button again, the voice guidance will be displayed.</p> <p>*Notice : You need to set the CLOUD as [OFF] in the viewer, only if you want to convert [withCLOUD] to GNET APP after you use [withCLOUD] APP.</p> <p>If you press the power button 1sec or 1sec twice, you can turn on/off the Wi-Fi signal. (G-ON, G-ON2, G-ON3, G-ON4).</p> <p>If your dash cam is not connected to the CLOUD, please check whether Wi-Fi is off.</p>

• ADAS Function - Android

Set the ADAS function at the GNET application.

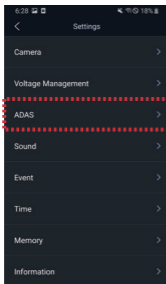

- ① **ADAS ON/OFF**
Turn on and off all sub-features of ADAS at once.
- ② **LDWS(Lane Departure Warning System)**
When the car leaves the lane, the detection alarm will go off. LDWS only works if it is above the set speed.
- ③ **FVSA (Front Vehicle Start Alarm)**
When the distance between the car and the front is more than 2m away, the warning alarm beeps.

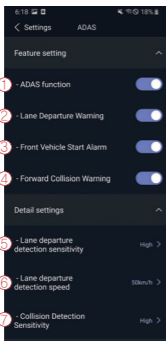

- ④ **FCWS (Forward Collision Warning System)**
When the driver approaches very close to front vehicle, the alarm will be ringing
- ⑤ **Lane departure detection sensitivity**
Set the sensitivity as following 3 steps.
(Lower, Medium, Higher)
- ⑥ **Lane departure detection speed**
Set the lane detection speed limit.
(50km/h, 60km/h, 70km/h)
- ⑦ **Collision detection sensitivity**
Set the collision detection sensitivity as following 3 steps.
(Lower, Medium, Higher)

- ADAS Lane correction - Android

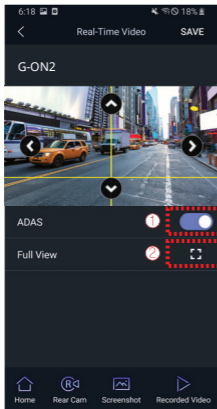

To improve the ADAS recognition rate, it is recommended to adjust the dash camera position by matching the end of the vehicle bonnet line on condition that "the lane correction button" is turned on in the real time screen.

- ① Guidance lines on/ off
- ② Full screen view (landscape)



- ① Up direction
- ② Left direction
- ③ Right direction
- ④ Downward direction
- ⑤ Back
- ⑥ Save
- ⑦ Guideline view on / off
- ⑧ Screen zoom out

- Dash cam Power On/Off

Press the power button to turn the system off.

To restart the system, press and hold the power button.

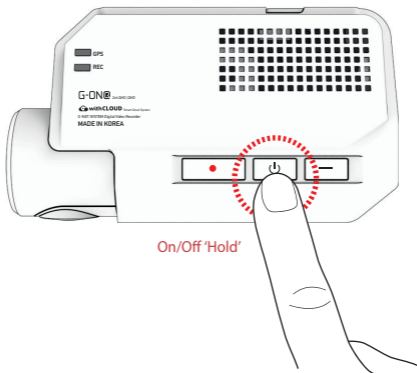

In case of turn the system off by holding the power button, you have to press and hold the power button again in order to restart the system.

- Wi-Fi On/Off

Wi-Fi On

The Wi-Fi power will be on when you press the power button for two times or press Wi-Fi button for 1 time.

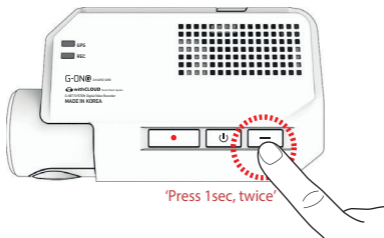

Wi-Fi Off

The Wi-Fi power will be off when you press the power button for two times.

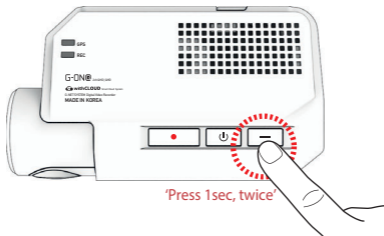

- Change Into Wi-Fi or Cloud Mode

The Wi-Fi mode is changed to the CLOUD mode or the CLOUD mode is changed to the Wi-Fi mode if you press the Wi-Fi button for 3~4 seconds.

(At this time, when switching to the Wi-Fi mode or the CLOUD mode, dash cam is on and does not reboot)

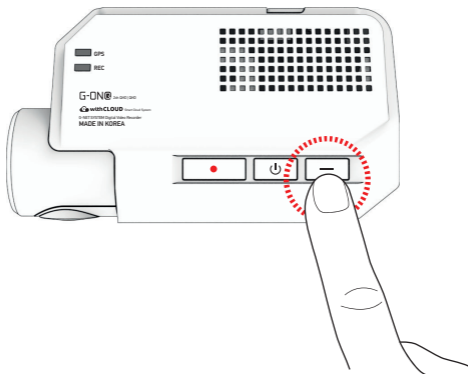

- Manual Recording

Manual recording begins when you press the button once.

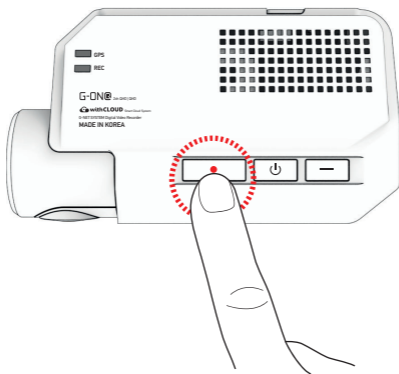

- Recording Mode

<p>Normal Recording</p>	<ul style="list-style-type: none"> - When the power is connected, the normal recording will start. - Security LED flickers left and right every 2 seconds. 	
<p>Event Recording</p>	<p>Impact Recording</p>	<ul style="list-style-type: none"> - If there is impact or shock, the record LED will flicker and record in event recording mode. - After event recording is finished, it will be automatically changed to normal recording mode.
	<p>Parking Recording</p>	<ul style="list-style-type: none"> - After the parking mode is entered when the ACC voltage is released, the parking mode automatically operates in 10seconds (3 Wired). - It is recorded in 10 frames, so the recording time can be extended. - Security LED flickers left and right every 4 seconds. - If it connects with ACC voltage, it switches to normal recording mode (3 Wired).
	<p>Motion Detection recording</p>	<ul style="list-style-type: none"> - Under parking mode, the device will record any movement happen within around 3 meters. - Security LED will quickly flicker. - When no motion is detected, it automatically changes to parking mode.
<p>Manual Recording</p>	<ul style="list-style-type: none"> - If press the manual recording button, the device will recognize the moment as an event and sort out the video in seperated folder 'manual'. - It is recorded in 30 frames and security LED will quickly flicker. 	

- Voice Guidance

CONTENTS	VOICE GUIDANCE
Normal recording	Start recording.
System Off	Shut down the system.
Overwriting	Recording does not have enough available. Please check overwriting setting.
GPS connection	GPS connected.
Abnormal recording	Video is not being entered.
Enable registration	Stand-by mode for Wi-Fi registration.
Disable registration	Stand-by mode for Wi-Fi registration.
No Wi-Fi Dongle (or in cloud mode)	No Wi-Fi Dongle
Complete the smartphone registration	Complete the registration.
Already registered smartphone	Already registered smartphone
Connect the Wi-Fi	User's connected.
Disconnect the Wi-Fi	User access disabled.
Connect the cloud	Cloud is connected.
Disconnect the cloud	Cloud is disconnected.

- Voice Guidance

CONTENTS	VOICE GUIDANCE
Change to cloud mode	Change to cloud mode.
Change to Wi-Fi mode	Change to Wi-Fi mode.
Wi-Fi power on	Wi-Fi power is on
Wi-Fi power off	Wi-Fi power is off.
Change the Smartphone setting	Setting changed and reboot.
Change parking mode to normal recording	Driving mode to start recording. Safe driving
Format the Micro SD memory card	On- formatting the memory card. Please wait
No Mirco SD memory card	No Memory card
Micro SD memory card damage	Memory card is damaged and can not be recorded
Micro SD memory file system recover	Reboot because of the damaged memory card. Please repace the memory card if this continues
Update the firmware	On installing the program. Do not turn off the power
Fail to firmware update	Program file is corrupt and can not be installed.
Event recording alarm	Impact event has occurred during parking
LBP ON	Shut down the system to protect the battery of car
LBP OFF	Restart the system to protect the battery of car

- 1 Remove the memory card after the device turns off.

- 2 Insert the removed memory card into the memory reader and connect it to the USB port on your PC.

- 3 Select the removable disk in the explorer folder.
 - Folders in the removable disk are displayed as shown on the following page.
 - When the event storage capacity is more than 10%, the [Events] folder is created.



Do not randomly delete or format files in the memory card.
Back up your important files in advance.

MEMORY CARD VIDEO FOLDER

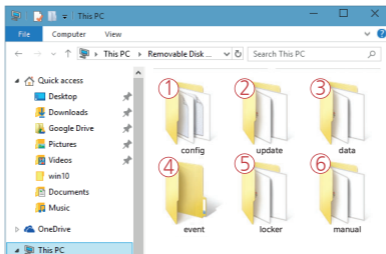

Predictable recording time of SD memory capacity (Default: All cameras : Max. 30 FPS)

8GB(40mins), 16GB(1.5hrs), 32GB(3hrs), 64GB(6hrs), 128GB(12hrs), 256GB(23hrs),
512GB(46hrs), 1TB(92hrs)

※ Total recording time may be different depending on use conditions and environment.

<p>① Config (Manage system)</p>	<p>Log.txt : It records the device's statement in a log file. Version.ini : Saving version information of device.</p>
<p>② Update (Firmware update)</p>	<p>The latest firmware is stores and updated automatically, or it can be updated by manually inserting the firmware.</p>
<p>③ Data (Normal recording)</p>	<p>Recordings are saved. File list numbers are different depending on the Micro SD memory card's capacity.</p>
<p>④ Event (Event recording)</p>	<p>Event (shock, movement) data is stored. * The 'Parking' event will be saved in the general data folder.</p>
<p>⑤ Locker (Event recording)</p>	<p>Event data(Impact, Parking, Motion) is stored.</p>
<p>⑥ Manual (Manual recording)</p>	<p>The manually record video is saved.</p>

- Download our smartphone app
 - Available for Android and Apple iOS. Search 'GNET' on Google Play and App Store.
 - Simply scan and access the QR code below.

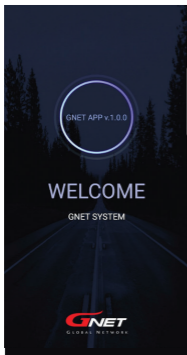

- Precaution before connecting the Smartphone
 - Set the time zone on the GNET app or the viewer.
 - Smartphone make, model, or specification can interfere and delay real time video playback.
 - DO NOT operate the device or adjust App settings while driving.
Please always safely pull over when interacting with GNET products.

SMARTPHONE CONNECTION

- How to connect an Apple iOS smartphone

- 1 Install the GNET application on the smartphone.
* G-net application is not available while cloud mode is on.



- 2 Press the Wi-Fi® button on the dash camera to enter standby mode with the voice message "Standby mode for Wi-Fi registration" (last 2 minutes)



- 3 Enter the Settings menu and proceed to locate and connect to the dash camera's Wi-Fi network (begins with GNET_BB_).



The password is as follows: **qwertyuiop**

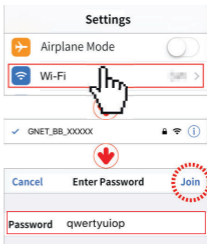

- 4 The registration of the dash camera is completed when you hear "User's connected".

* If the connection fails due to a weak Wi-Fi signal, please carefully unplug and immediately re-insert the Wi-Fi dongle back into the camera. Proceed to try the connection again by pressing the Wi-Fi button to enter standby mode.



- How to connect an Android smartphone

- 1 Install the GNET application on the smartphone.
* G-net application is not available while cloud mode is on.



- 2 Press the Wi-Fi® button on the dash camera to enter standby mode with the voice message "Standby mode for Wi-Fi registration" (last 2 minutes)



- 3 Touch the "+" to search for your device - use the left and right arrows scroll. Once your device has been located select the "Connect" button.

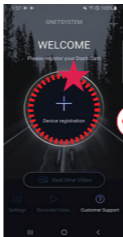

[★] will indicate first time connection to the device ▶



- 4 The registration of the dash camera is completed when you hear "User's connected".

* If the connection fails due to a weak Wi-Fi signal, please carefully unplug and immediately re-insert the Wi-Fi dongle back into the camera. Proceed to try the connection again by pressing the Wi-Fi button to enter standby mode.



• APP Main Screen Description

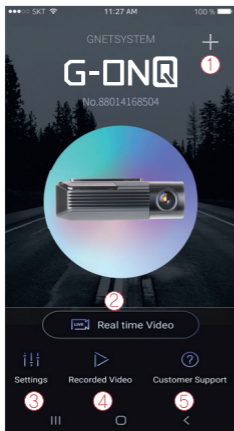

- ① This function allows you to connect other dash cams or delete the registered devices.
※ Supported only on Android mobile
- ② Real-Time Video
Select this button to view a live video feed from the dash camera.
- ③ Settings
You can easily toggle camera settings via your smartphone. When finished, select the "Save" button to reboot the system.
- ④ Recorded Video
View previously recorded video from the camera's SD card. Video can be downloaded directly onto the smartphone.
- ⑤ Customer Support
If you need product support, select this button to go to the Customer Support Center.

- Both mobile apps(Android / iOS) and web are available.



- App



withCLOUD



- Web (You can access it through the address below)

<https://cloud.gnetsystem.com>

- Main (PC)

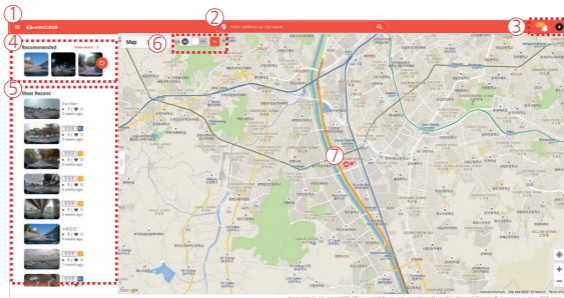

① Menu button

② Location search(Enter City or Address) : The map moves to the area you searched for.

③ Event alarm : It is displayed when an event occurs, and when you press an event in the list, the video is played.

User icon : You can select Channel / Settings / Logout

④ Recommended : The video is recommended in the order of high views and likes.

Press 'View More' to go to the recommended video page.

⑤ Recent videos : The latest shared video will be displayed based on location.

⑥ Show only my vehicle : Function to show only my vehicle on the map. Can set ON/OFF.

Quick menu(My vehicle) : Run basic menus right away without finding a vehicle on the map.
(If there are multiple vehicles, this is the most recently accessed vehicle.)

⑦ Vehicle icon

Other user's vehicle



My vehicle(Driving)



My vehicle(Parking)



- Main (Mobile)



- ① Menu button
- ② Event alarm : It is displayed when an event occurs, and when you press an event in the list, the video is played.
User icon : You can select Channel / Settings / Logout
Location search(Enter City or Adress) : The map moves to the area you searched for.
- ③ Open/fold the side tabs : Press the button to open and close the left tab.
- ④ Recommended : The video is recommended in the order of high views and likes.
Press 'View More' to go to the recommended video page.
- ⑤ Recent videos : The latest shared video will be displayed based on location.
- ⑥ Show only my vehicle : Function to show only my vehicle on the map. Can set ON/OFF.
Quick menu(My vehicle) : Run basic menus right away without finding a vehicle on the map.
(If there are multiple vehicles, this is the most recently accessed vehicle.)

- ⑦ Vehicle icon

Other user's vehicle



My vehicle(Driving)



My vehicle(Parking)



- Live video / Recommended

Live video

You can check the real-time image by selecting the vehicle icon of the user who shared your vehicle or location/video on the map.

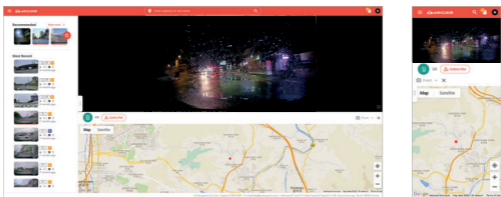

Recommended

The function of recommending videos with high views and likes. If you press 'More' in the recommended video on the main screen, it moves.

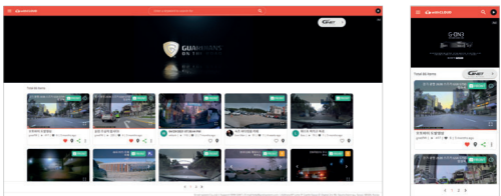

- Event videos / Channel

Event videos

A screen where I collect event videos of my vehicle. You can set up or delete sharing, and search for videos by date/vehicle/event.

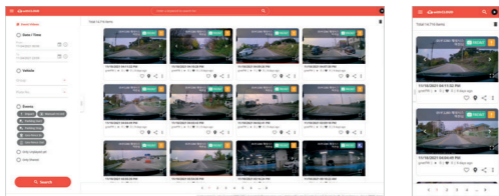

Channel

You can view the event video shared by the user, the subscription channel, and the shared video that you like.

Live video of my vehicle is displayed at the lower end of the profile area.

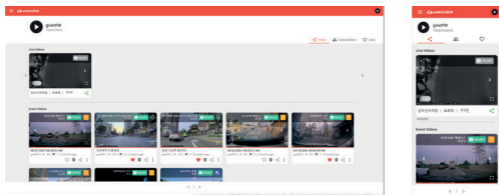

- Vehicle management / GPS Tracking

Vehicle management

In the registered vehicle, such as setting the location of my vehicle, setting the black box, and setting the cloud plan, all settings related to it are possible.

You can check by selecting the photo/text mode of the list.

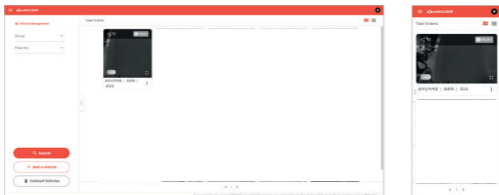

GPS Tracking

You can view the driving record of the vehicle by date, vehicle, and section, and an event while driving. The details are also displayed. If you press the driving history, you can know the driving time, mileage, and departure/arrival time.

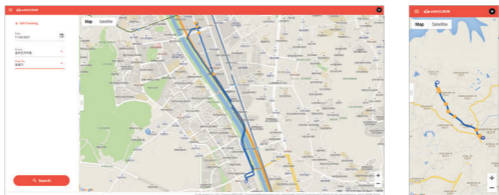

! The PC specification should be over 'CPU i5 3.0 GHz, Memory 4GB' to play the Full HD. If the PC specification is lower than standard, it is possible to happen "No-play back" or disconnect

- 1 PC viewer program is not installed in case of first use or when format the memory card.

- 2 Insert the Micro SD memory card and turn on the device.

- 3 Depends on the capacity, the recording time will be different. At first use, take 3~5 minutes to initialize and create the file system (All LED flicker while initializing. After it starts recording, REC LED will turn on) Therefore do not turn off the power

- 4 Insert the Micro SD memory card to PC

- 5 Install the [Viewer.exe] file in the Micro SD memory card as picture shown.

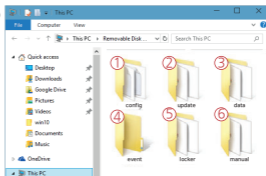

- 6 Click the [YES] button on the user control menu.

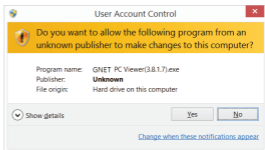

- 7 Click the [Next] button and click the [Installation] button.

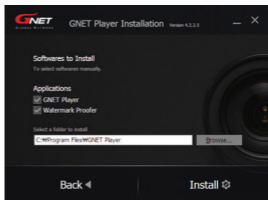

- 8 Confirmation the latest version pop-up will appear as picture shown if network is connected. If there is no internet connection, PC Viewer program will be executed directly.



- 9 Click the [Execute a viewer] button to start viewer program.

- 10 When the installation is completed, the PC Viewer program runs automatically and Gnet icon will be created on the computer.



- 11 [Open the file]

When click the file button() the browse folder will appear like picture. And select removable disk, Press [OK] button.

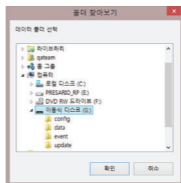

• PC Viewer (Window)



① Tool Box

	Save		Folder Open
	Print		Setting

② Google Map

When GPS and internet are connected, it will work normally

③ Playlists and Information Display

④ GPS reception window

It can be used only when GPS is connected

⑤ Video control popup

	Thumbnail
	Draw a lane
	View a video
	Split View
	PIP View
	Toggle (change) color
	black and white mode

⑥ G-sensor (acceleration) graph

⑦ Speedometer

(It can be used only when GPS is connected)

⑧ Play a recorded video

	Reverse and forward play
	Pause
	Repeat event video
	Previous, Next Event
	Play one frame

⑨ Adjust playback speed

⑩ Sound control

- How to Check G-sensor data

When you play the video, three-dimensional coordinate system information (G-sensor data) on the X-axis(progress direction), Y-axis (left-right), and Z-axis (height) of the image currently being played at the G-sensor data location is output.



<Magnification of G-sensor data>

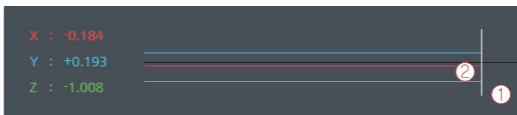

- ① The location of the image currently being played
- ② Numerical values and graphs of three-dimensional coordinate system information (G-sensor data)