

Technology • Art • Sound
Manufactured by
elettromedia Italy



ML Power

ADVANCED WEB MANUAL

ML Power 1

rev 1.0 c

The User Manual is also
available from our web site
www.hertzaudiovideo.com

www.hertzaudiovideo.com

HERTZ
The Sound Experience

Index

1. INTRODUCTION	3
2. PACKAGE CONTENTS	3
3. SAFE SOUND	4
4. GENERAL PRECAUTIONS	5
5. INSTALLATION AND SIZE	6
6. BATTERY / REMOTE CONNECTION AND HOW TO REPLACE THE FUSE	7
7. AUTO TURN-ON WITH HI-LEVEL INPUTS	7
8. TOP PANEL CONTROLS: SWITCHES AND ADJUSTMENT CONTROLS	8
9. FRONT AND REAR PANELS	9
10. CONFIGURATION DIAGRAMS	
HOW TO USE REMOTE VOLUME CONTROL	11
PRE-IN FOR ONE SUBWOOFER	11
PRE-IN FOR TWO SUBWOOFERS	12
HI-IN INPUT	13
HI-IN INPUT AND PRE-OUT	14
PRE-IN FROM PROCESSOR OUTPUT	15
11. CABLES	16
12. BLOCK DIAGRAM	17
13. TECHNICAL SPECIFICATIONS	18

1 INTRODUCTION

Thank you for purchasing a Hertz product, designed according to the highest quality standards.





Your ML Power amplifier is a cutting-edge product of compact size, providing high power and quality of sound.

It will definitely ensure you maximum satisfaction by taking up very small room in your vehicle.

Before the installation, in addition to reading the Quick Start Guide (QSG), the consultation of this user's manual available on the Hertz website will let you achieve the highest performance from your amplifier.

2. PACKAGE CONTENTS

In the package, besides your amplifier, you will find:

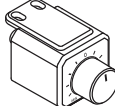
- Quick Start Guide 
 - Warranty Card 
 - 40 A blade fuse  x3
 - 4,2 x 16 mm self-tapping, cross-headed fixing screws  x4
- OPTIONAL**
- HRC BM: SUB volume control 

3. SAFE SOUND

HERTZ AMPLIFIERS CAN BE PART OF A HIGH POWER AUDIO SYSTEM THAT CAN GENERATE VERY HIGH UNDISTORTED SOUND PRESSURE LEVELS. PLEASE REMEMBER THAT LONG EXPOSURE TO AN EXCESSIVELY HIGH SOUND PRESSURE LEVEL MAY DAMAGE YOUR HEARING; THEREFORE, PLEASE USE COMMON SENSE AND PRACTICE SAFE SOUND.

Safety must be at the forefront while driving. The listening volume should never obscure the noise coming from the outside of your vehicle; you should be able to hear the sounds generated by your vehicle in order to promptly face any emergency situation.

To achieve the best possible performance from your new components, we recommend you follow the instructions in this manual carefully. In order to design and create top level car hi-fi systems you need to understand automobile mechanical and electrical issues very well; if you think you lack the required knowledge or the proper tools, please consult with a specialized installer.

A professional installation will ensure your system delivers all the performance you have paid for, without affecting the safety and reliability of your vehicle.

This manual has been designed to provide you with the basic instructions required to install and use this product. However, the range of possible applications is very wide; to obtain further information, please contact your authorized Hertz dealer or Hertz service center.

You can also send an e-mail directly to the following addresses:

Italy - supporto.tecnico@elettromedia.it

Worldwide - support@elettromedia.it

4. GENERAL PRECAUTIONS



- This symbol indicates that you have to pay attention to these instructions. Disregarding them might cause accidental harms or damage your amplifier.
- Before installing the amplifier, make sure you carefully read and understand all instructions.
- The vehicle electric system must have 12V DC voltage with negative to ground. Make sure your car has it in order to avoid any damages to your amplifier and to the vehicle.
- Pre-plan the configuration of your new amplifier and the best wiring routes to ease installation.
- Always wear protective eyewear when using tools that may generate splinters.
- During installation, keep the amplifier in its packing as long as possible; this will protect it from damages.
- Secure all auxiliary devices you built to install the components to the vehicle structure through brackets, screws, nuts and bolts; this insures stability and safety while driving.
- The amplifier detachment while driving can damage the people in the vehicle and other cars. Secure the amplifier at best, paying utmost attention if installation is inside the passenger's compartment. Do not carry out any installation inside the engine compartment.
- Before installing the amplifier, turn off the source and all other electronic devices in the audio system for preventing any damages.
- Make sure the location you chose for the components does not affect the correct functioning of the vehicle mechanic and electric devices.
- Do not run the cables or install the amplifier next to electronic gearcases.
- Use extreme caution when cutting or drilling the car plate, checking there are no electrical wiring or structural element underneath.
- Before connecting the power cable to the amplifier, disconnect the negative lead (-) from the car battery.
- Make sure power cable is not short circuited during installation and connection.
- Power cable must have mechanically resistant and self-extinguishing insulation. Its section have a size corresponding with what is suggested in this manual. Avoid to run it over or through sharp edges or close to moving mechanical devices. Make sure it is well fixed all along its length. Block positive and negative cables just close to the amplifier respective power supply terminal blocks through a clamping screw.
- Use rubber grommets to protect the wire if it runs in a hole of the plate or proper materials if it is close to heat-generating parts.
- To ground the device (-) in the right way, use a screw in the vehicle chassis; scrape all paint or grease from the metal if necessary, checking with a tester that there is continuity between the battery negative terminal (-) and the fixing point. If possible, connect all components to the same ground point; this solution rejects most noise.
- Route all signal cables away from power cables.
- Never run cables outside the vehicle; you would not be protected against wear and in case of accidents.
- When installing speakers and the cables that connect them, make sure that non-insulated parts never touch, even occasionally, the vehicle cutting parts. If they do, the amplifier protection is activated.
- To prevent all problems, use very good quality cables, connectors and accessories, choosing them in Connection catalogue.
- When installation is over, and before plugging the main power supply fuse, check the system wiring and make sure all connections were done in the right way.
- Power amplifiers put an increased load on the battery and on its charging system. We recommend checking your alternator and battery condition to ensure they can handle the increased consumption. Standard electrical systems which are in good condition should be able to stand this extra load without problems but we recommend the use of an energy storage capacitor and/or a battery for high level audio systems.
- Put a fuse and its insulated fuse holder 40 cm max. far from the battery positive terminal; connect one end of the power cable to it after connecting the other end to the amplifier. The fuse value must be 50% higher than the amplifier built-in one. In case the cable supplies several amplifiers, the fuse value will have to be 50% higher than the sum of the values of all other fuses in the amplifiers.
- There must be good air circulation where the amplifier is installed; this area must not be affected by humidity, rain, external deposits or parts coming from the vehicle mechanical devices. Do not hinder in any way the cooling of the amplifier side fins
- Install the amplifier in the vehicle parts where temperature is between 0°C (32°F) and 55°C (131°F).

WARNING: When working in demanding conditions, the amplifier can reach temperatures of around 80 - 90°C (176- 194°F). Make sure it is not dangerously hot before touching it.

- Periodically clean the amplifier without using aggressive solvents that might damage it. Dampen a piece of cloth with water and soap, wring it and clean the amplifier. Then use a piece of cloth dampened with water only; eventually clean the amplifier with a dry piece of cloth.
- Remove dust and solid deposits from the heat sink side fins. Don't use compressed air on the amplifier since it would push solid parts in the amplifiers. If necessary, please contact a specialised service centre for internal cleaning. Cooling system obstruction makes the amplifier go in safety mode.

5. INSTALLATION AND SIZES

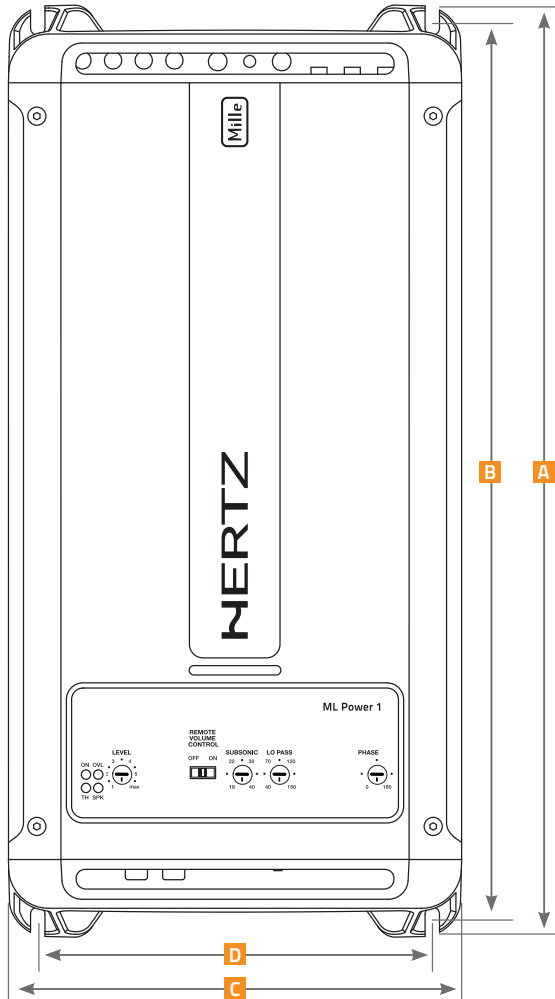

	A	B	C	D	E	
ML Power 1	349	332	170	148	46,7	mm
	13.74	13.07	6.69	5.83	1.84	in.

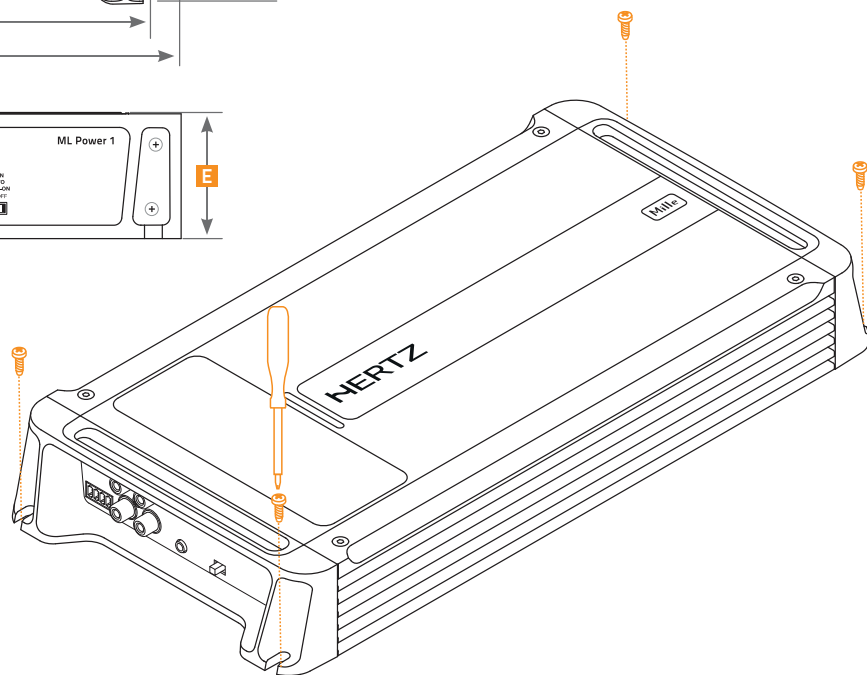
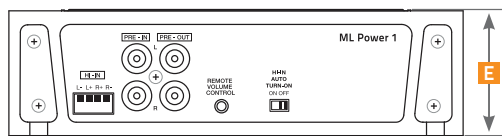

6. BATTERY / REMOTE CONNECTION AND HOW TO REPLACE THE FUSE

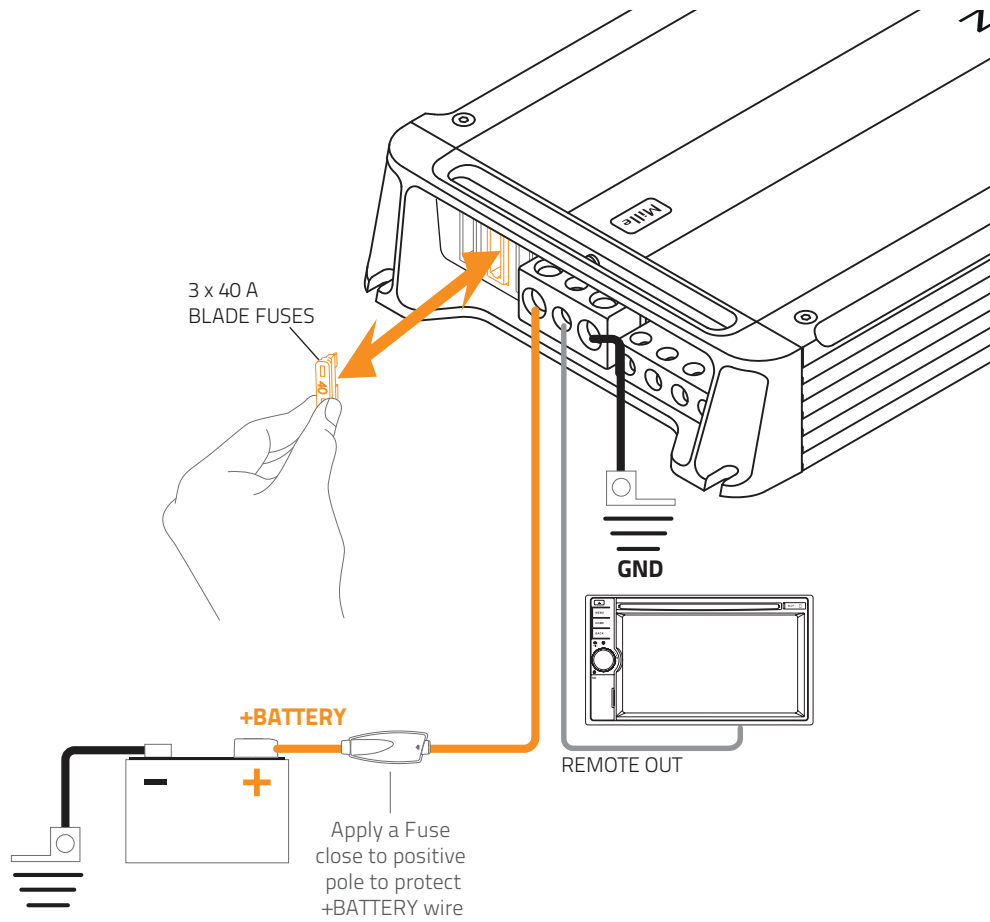

7. AUTO TURN-ON WITH HI-LEVEL INPUTS

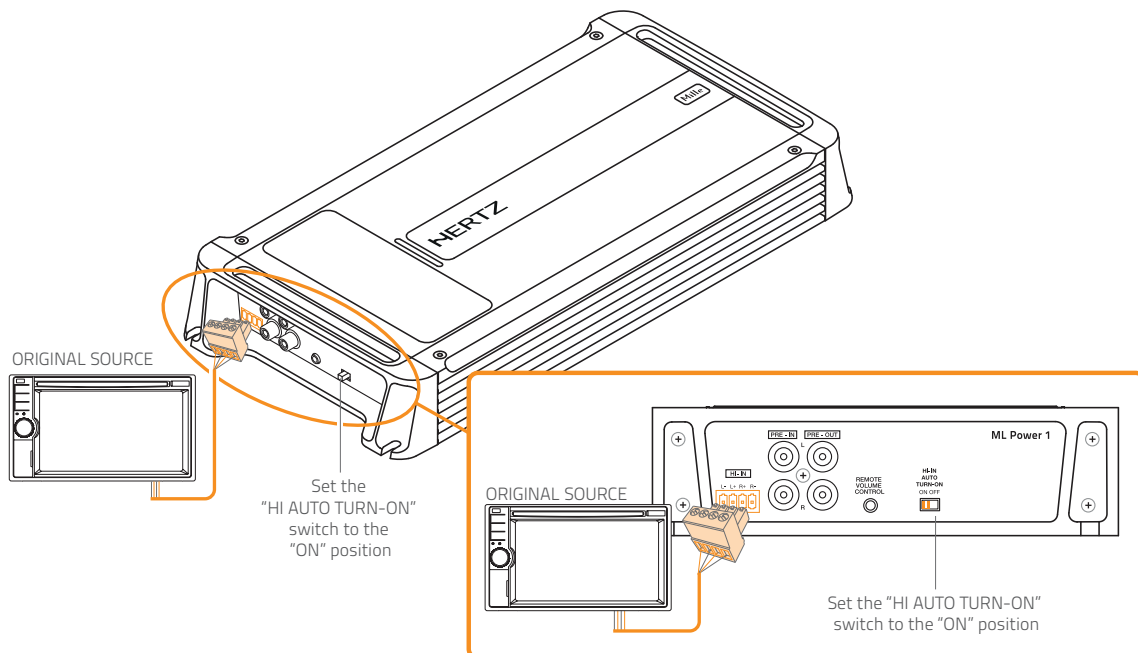

8. TOP PANEL CONTROLS: SWITCHES AND ADJUSTMENT CONTROLS

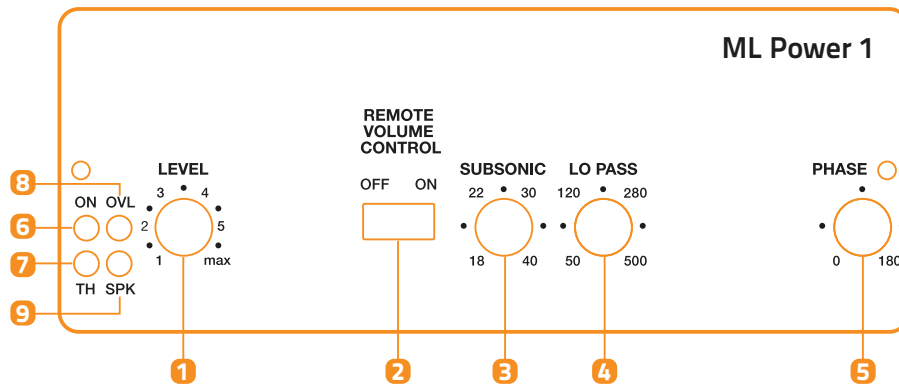

- 1 LEVEL: Input sensitivity adjustment control.** Set to 1 position. Use a CD as source, increase head unit volume until output distorts, then decrease volume by 1 step in order to eliminate distortion. Turn LEVEL up until sound becomes distorted, then turn LEVEL down a bit for optimum sound.
- 2 REMOTE VOLUME CONTROL (ON - OFF):** Activate **ON** or deactivate **OFF** external remote volume control. Connect external adjustment control to front panel proper connectors.
- 3 SUBSONIC: (18 Hz ÷ 40 Hz): Crossover point (Hi-Pass filter) adjustment.** Rotating the knob you can select any frequency between 18Hz and 40Hz. The frequencies below the crossover point will be attenuated at 24dB/Oct. This control is useful to remove ultra-low frequencies present in some audio signals which do not contribute to music information and might cause distortion or abnormal warming.
- 4 LO-PASS (50 Hz ÷ 500 Hz): Crossover point adjustment.** Rotating the knob you can select any frequency between 50Hz and 500Hz. The frequencies above the crossover point will be attenuated at 24dB/Oct.
- 5 PHASE (0° ÷ 180°): Phase signal rotation point adjustment.** Rotating the knob you can select any phase angle between 0° and 180° (phase reversal). The PHASE angle is centered at 80Hz. For frequency beyond or below this value, phase angle decrease. While listening to the front loudspeaker (driven from other amplifier), adjust PHASE in order to have a good bass response.
- 6 ON: Power LED.** It lights up when you turn on the amplifier. If all LEDs (6) (7) (8) (9) turn on at the same time, the amplifier will shut down and you will have to contact a service centre.
- 7 TH: Terminal status LED.** It lights up when thermal protection is active, above 85°C. The amplifier shuts down until the chassis temperature goes below 75°C.
- 8 OVL: Overload status LED.** It lights up when overload occurs on the power output terminals. The amplifier goes in muting for 3 seconds and this LED starts flashing until you turn off the amplifier. **REMOVE THE CAUSE OF OVERLOAD.**
- 9 SPK: Speaker status LED.** It lights up when a speaker touches the car body. The amplifier goes in muting for 3 seconds and this LED starts flashing until you turn off the amplifier. **REMOVE THE CONTACT BETWEEN SPEAKER WIRE AND CAR BODY.**

9. FRONT AND REAR PANELS

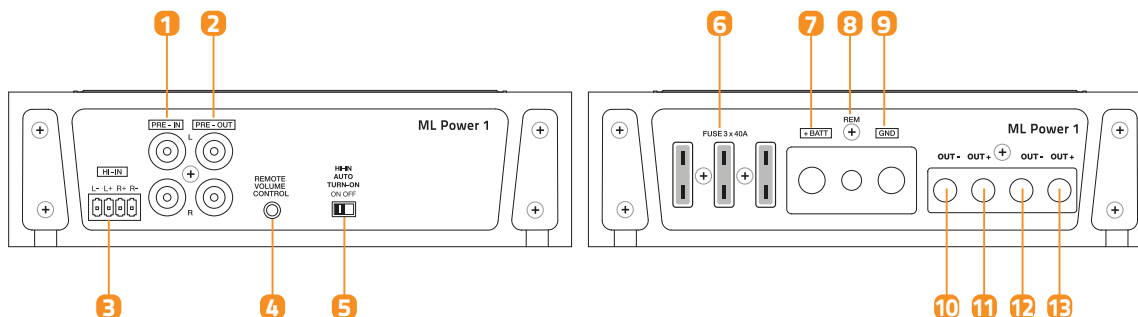

- 1 PRE-OUT** This jack provide Left and Right pre-amplified outputs to drive a separate amplifier. These signals are full range, without crossover action.
- 2 PRE-IN:** Left and Right pre-amplified inputs. Drive power output with L and R mixed signal. Connect to pre-amplified source output. Signal can be 0.2 to 5V RMS.
- 3 HI-IN:** Hi-Level signal Left and Right inputs. If the head unit does not feature a pre-amplified output, connect here its speaker wire to drive Left and Right channels. Signal can be 0.8 to 20V RMS.
- 4 REMOTE VOLUME CONTROL:** Input for REMOTE SUB VOLUME CONTROL. Connect here the adjustment control that the amplifier features (optional).
- 5 HI-IN AUTO TURN-ON (ON - OFF):** Select **ON** to turn on the amplifier through the speaker power cable, if the source does not feature a 12V DC REMOTE OUT. Select **OFF** if REMOTE OUT from the source is available.
- 6 PROTECTION FUSE:** 3 x 40A
- 7 POWER (+ BATT):** Terminal block for the amplifier 11 ÷ 15V DC power supply positive pole connection. Insert here the battery positive cable. The plug accepts cables up to 2 A.W.G.
- 8 REMOTE IN:** REMOTE IN terminal for the remote cable coming from the device which turns on the amplifier. Voltage must be between 7 and 16V DC.
- 9 POWER (GND):** Terminal block for the amplifier power supply negative pole connection. Insert here the battery negative cable or wire connected to the vehicle chassis. The plug accepts cables up to 2 A.W.G.
- 10 OUT - Speaker OUT:** Negative power terminal, connect to negative speaker terminal.
- 11 OUT + Speaker OUT:** Positive power terminal, connect to positive speaker terminal.
- 12 OUT - Speaker OUT:** Negative power terminal (same output as nr.10), connect to negative terminal of second speaker if needed.
- 13 OUT + Speaker OUT:** Positive power terminal (same output as nr.11), connect to positive terminal of second speaker if needed.

10. CONFIGURATION DIAGRAMS

HOW TO USE REMOTE VOLUME CONTROL

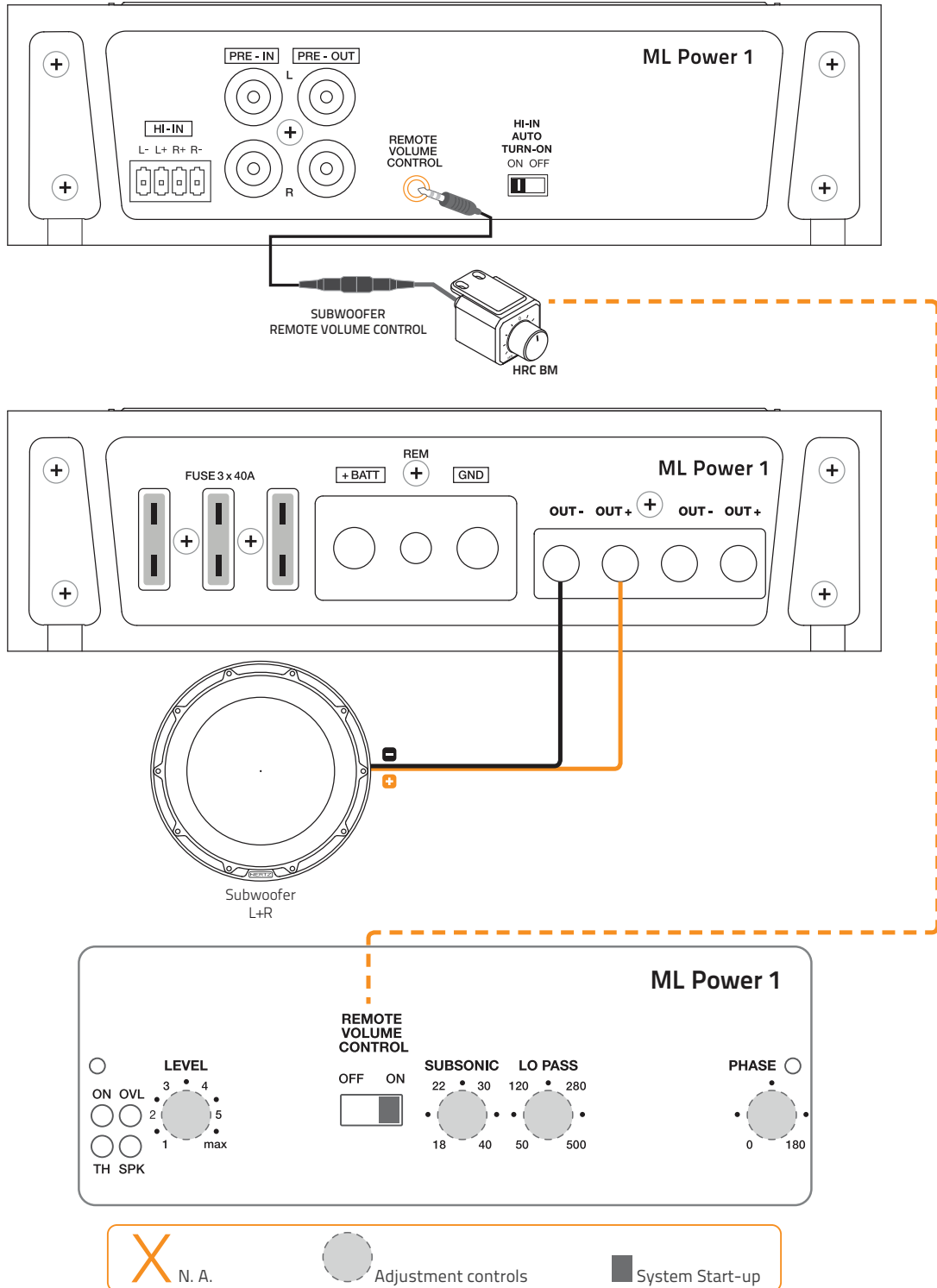

PRE-IN FOR ONE SUBWOOFER

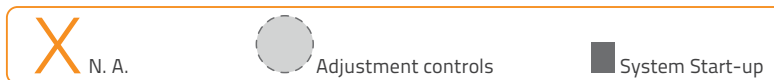
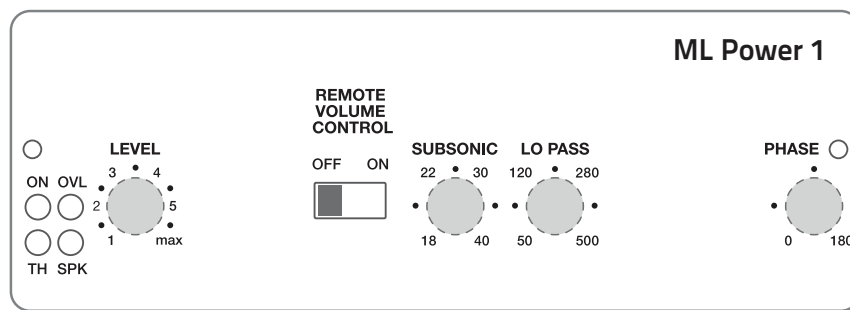
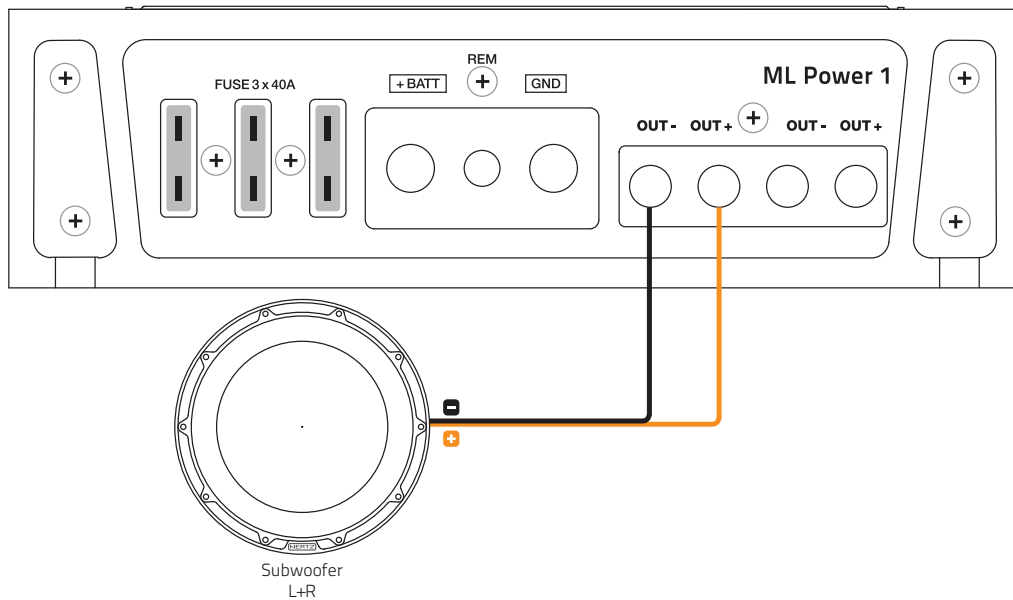
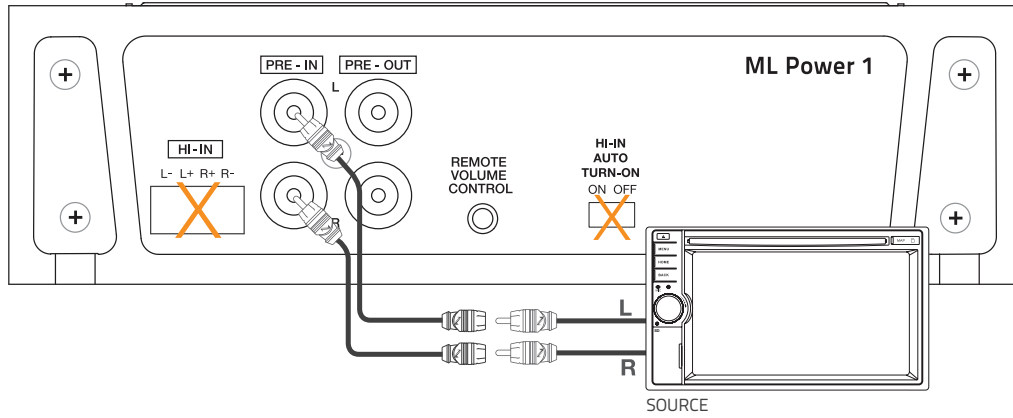

PRE-IN FOR TWO SUBWOOFER

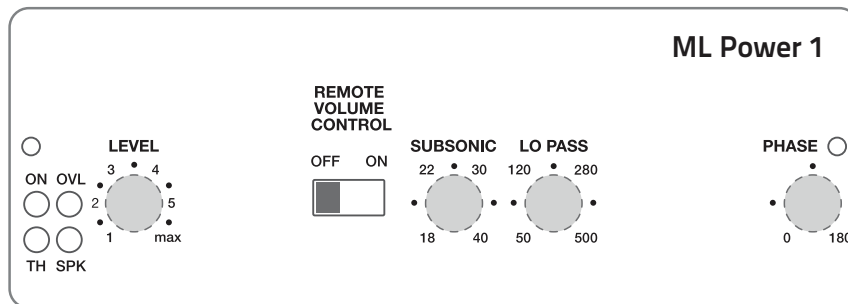
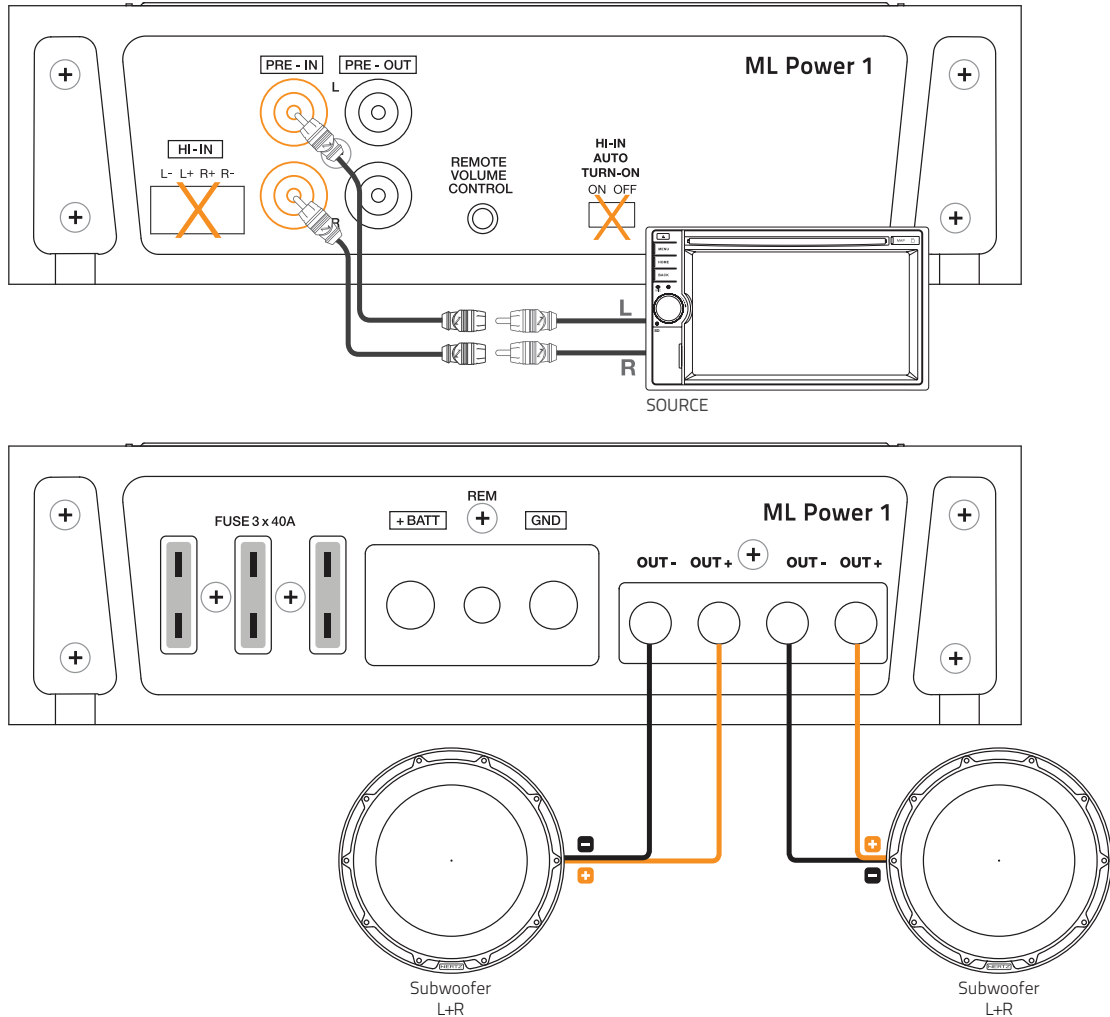

X N. A.
 Adjustment controls
 System Start-up

HI-IN INPUT

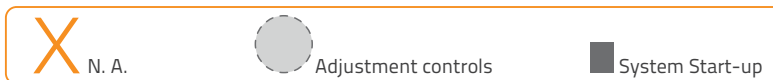
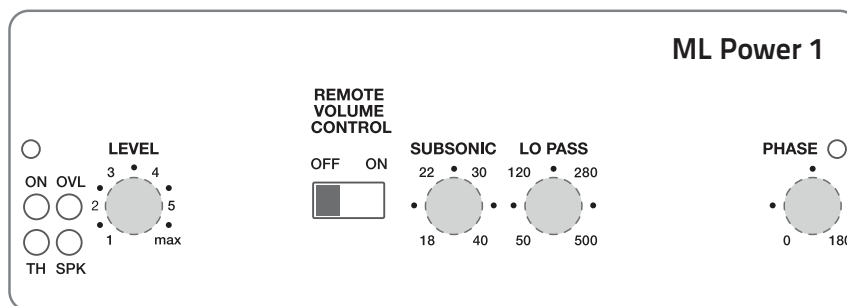
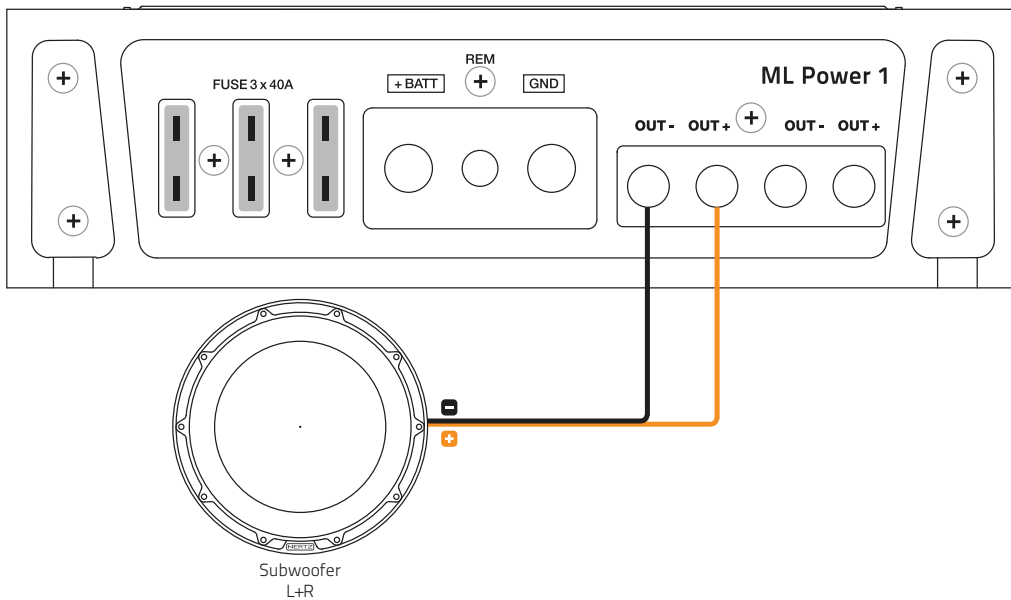
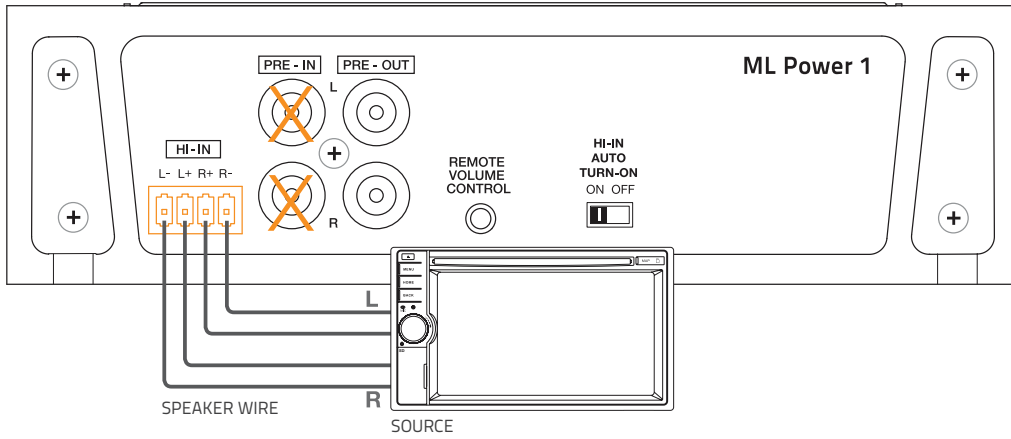

HI-IN INPUT AND PRE-OUT

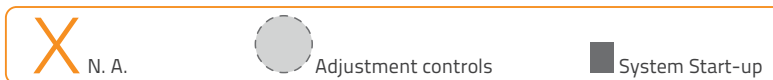
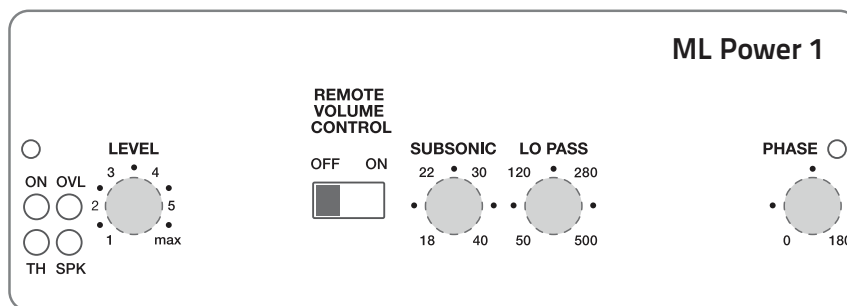
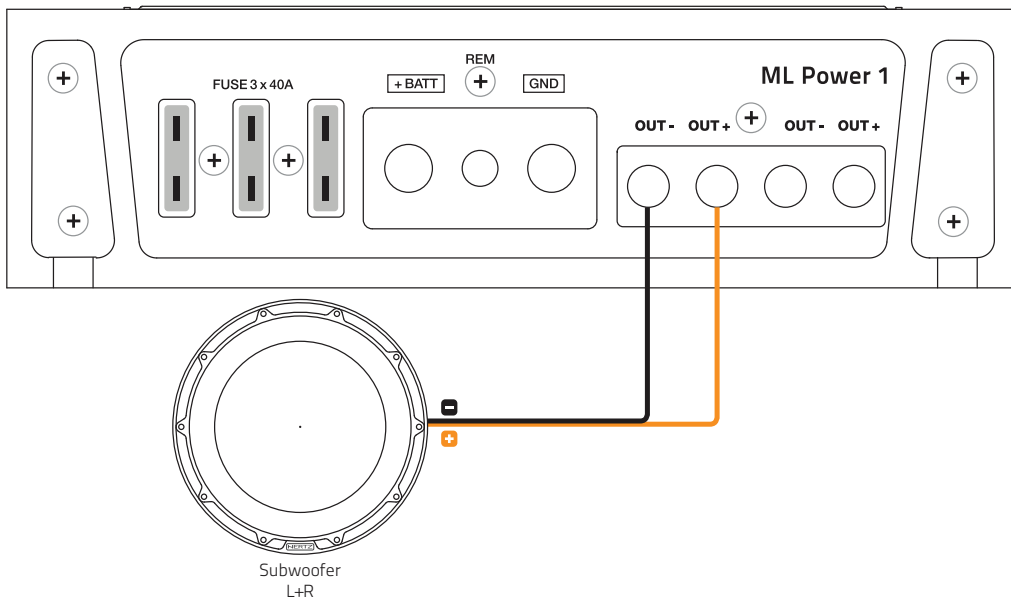
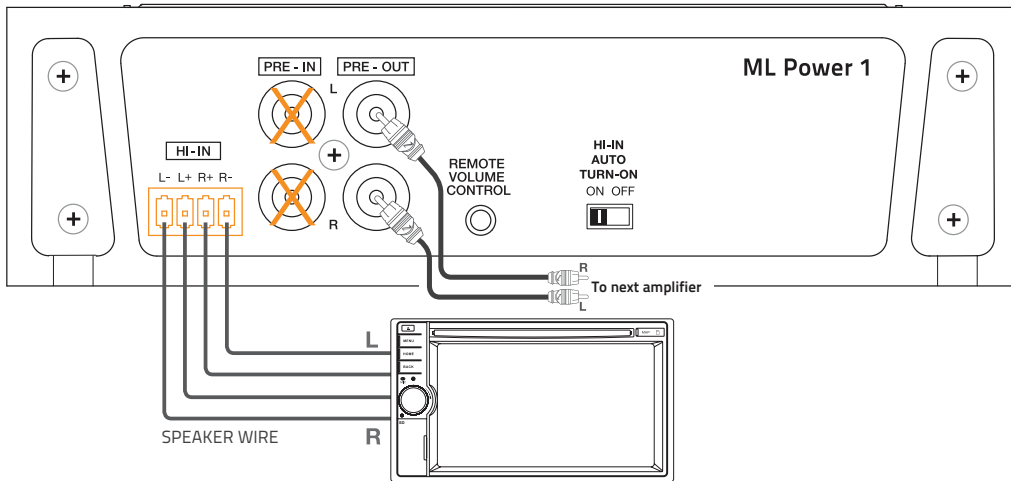

PRE-IN FROM PROCESSOR OUTPUT

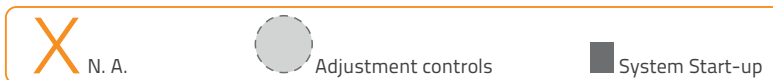
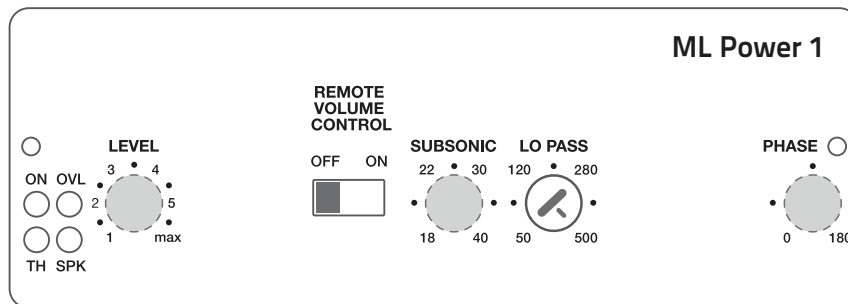
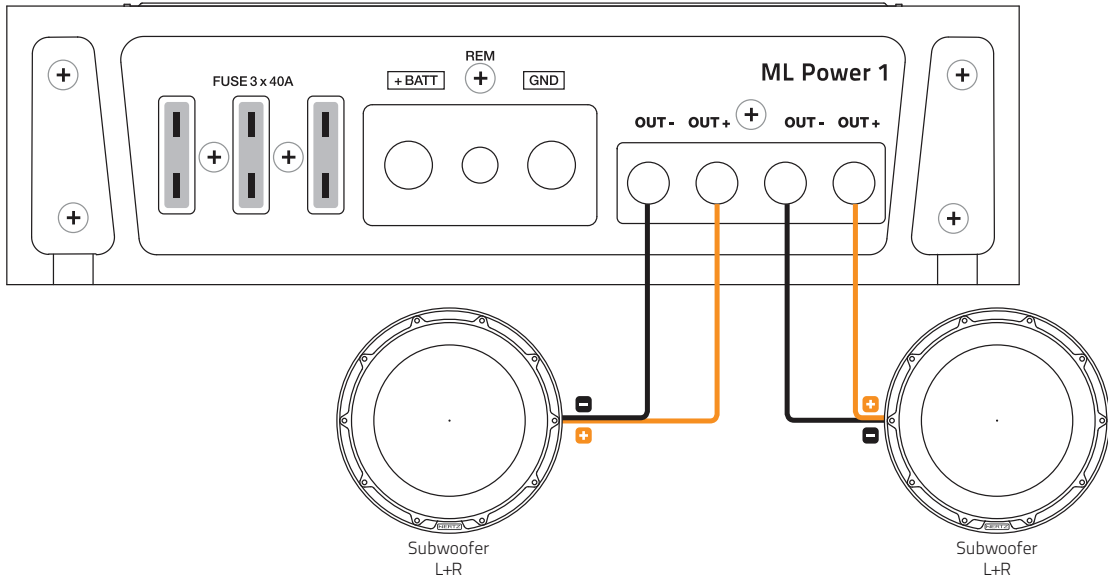
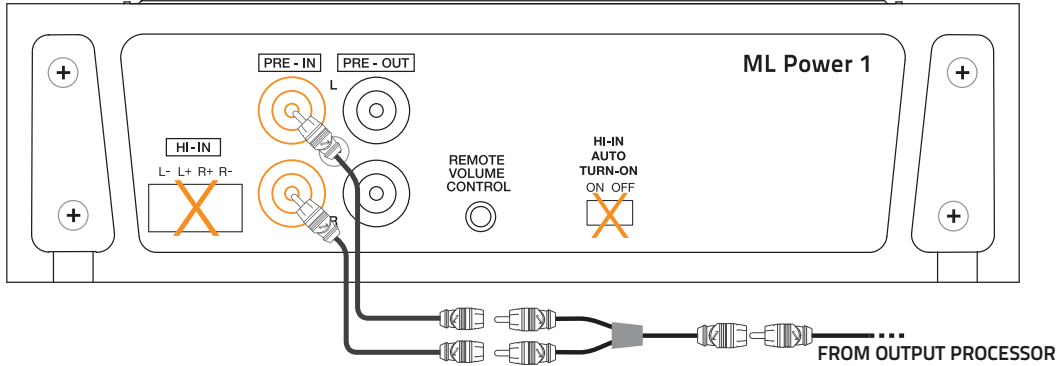

11. CABLES

Connection cables

For maximum performance, always use new, good quality cables; their outer jacket must not be spoiled, and the copper must not show oxidation. For proper operation, always consider the length of the connection, the load and the current it has to handle. Connection products are the most flexible and complete; they are designed and built in order to get the best out of every installation, especially when used with Hertz amplifiers.

Speaker cable recommendations

The table refers to continuous power into 4 Ω load. If load decreases, cable size will have to increase proportionally.

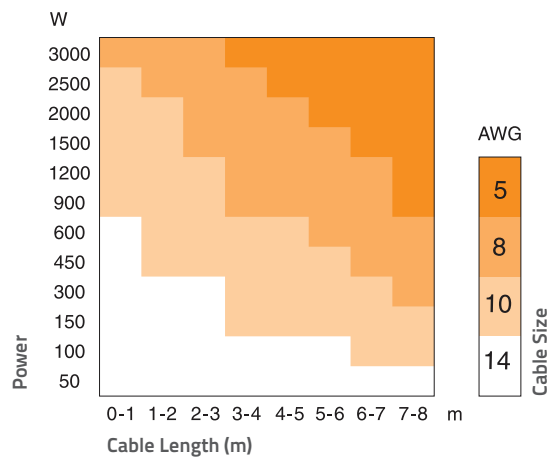

Power and Ground cable recommendations

If you don't know your system current consumption, find it using the mathematical formula below and find this same value on the left hand column of the table. Then calculate the length of your connection and find this same value on the bottom column of the table. At the point where these two values cross is the minimum section in gauge (A.W.G.) which Connection recommends for building a high performance, reliable system.

How to calculate your system current consumption

$$I = \frac{TP \times 2}{V_{batt}}$$

I = Current consumption of your system in ampere (A);

TP = Total power (RMS) of channels of all amplifiers in your system;

V_{batt} = Usually value is 12 V, the nominal automotive electrical system voltage.

Example:

- Your total system power (RMS) of all channels in all amplifiers is a combined 650 W.
- Your amplifier average is 50% efficiency, as most amplifiers today.
- Your electrical system is 12 V.

$$I = \frac{650 \times 2}{12} = 108,3 \text{ A Current consumption}$$

Power & Ground cable calculation table		Cable Size	
Minimum gauge size recommended for MAINPOWER & POWER FLOW cables. MAINPOWER cables ensure higher instantaneous current transfer.		A.W.G.	mm ²
240-350		1/0	53,5
180-240		2	33,6
150-180		4	21,2
120-150		8	8,4
100-120		10	5,3
80-100		12	3,3
60-80		14	2,1
40-60		16	1,3
20-40		18	0,8
8-20			
0-8			
	0-1 1-2 2-3 3-4 4-5 5-6 6-7 7-8		

12. BLOCK DIAGRAM

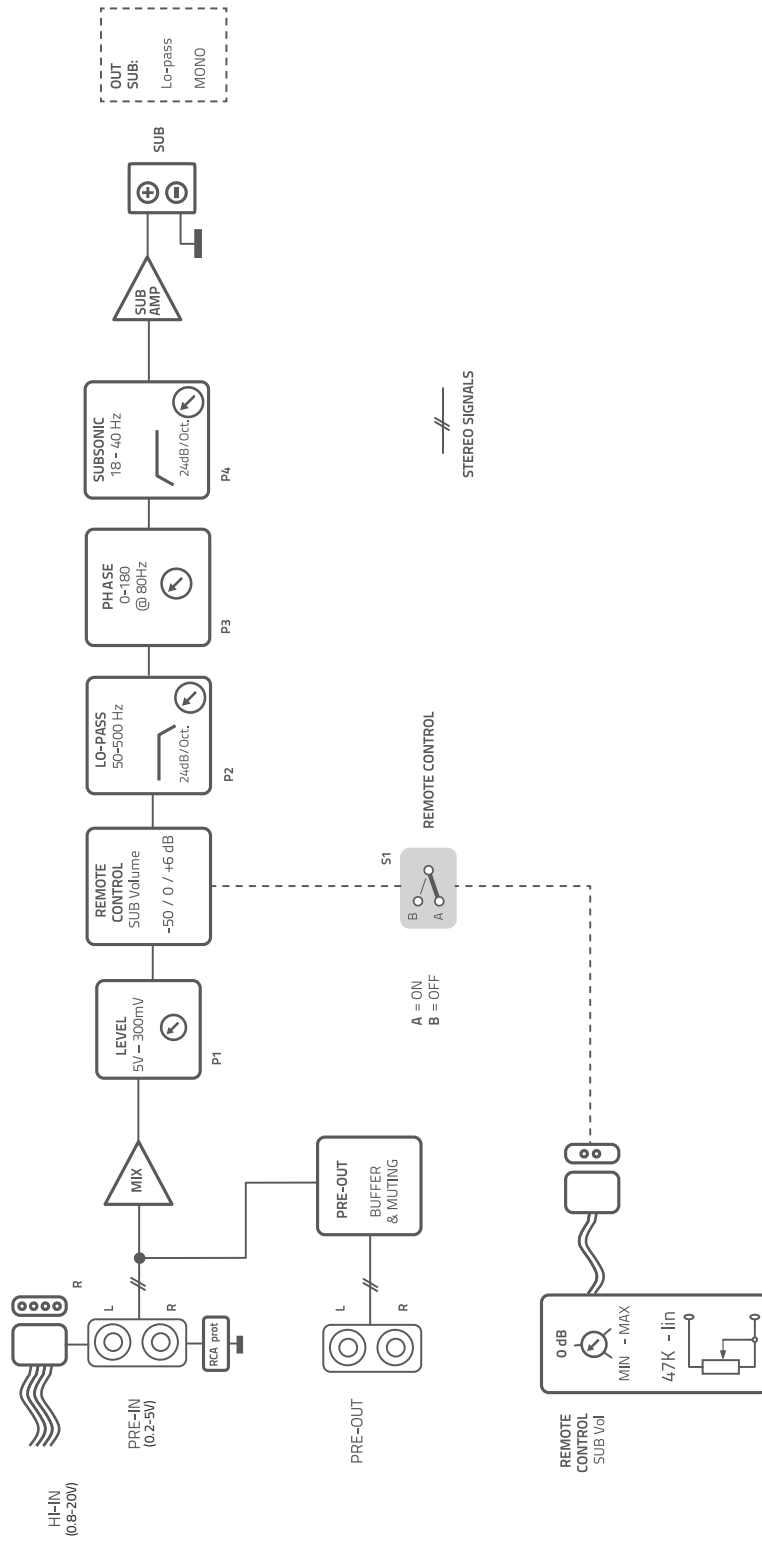

13. TECHNICAL SPECIFICATIONS

Power Supply	
Power supply voltage / fuse:	11+15 VDC
Idling current:	2 A
Idling current when OFF:	0.04 mA
Consumption @ 1 Ω , 14.4 VDC (Max Musical Power):	83,5 A
Remote In:	4 + 15 VDC - 1 mA
ART TM :	Automatic Remote Turn-On/Off with Speaker-In
Fuse:	3 x 40 A

Amplifier Stage	
Distorsion - THD (100 Hz @ 4 Ω):	0.08 %
Bandwidth (-3 dB):	18 + 500 Hz
S/N Ratio (A weighted @ 1 V):	105 dB
Damping factor (100 Hz @ 4 Ω):	100
Pre-In sensitivity:	0.2 + 5 V RMS
Pre-In impedance:	15 k Ω
Speaker-In sensitivity:	0.8 + 20 V RMS
Speaker-In impedance:	470 Ω
Load impedance (MIN) @ 1 Ch:	4 + 1 Ω :
Output Power (RMS) @ 14.4 VDC, THD 1%:	
1 Ch:	600 W x 1 (4 Ω)
1 Ch:	1000 W x 1 (2 Ω)
1 Ch:	1000 W x 1 (1 Ω)
CEA 2006-A Ratings:	
RMS Power (4 Ω , \leq 1 %THD+N, 14.4 V):	600 W x 1 Ch
S/N Ratio (ref. 1 W output):	83,5 dBA



Inputs / Outputs / Filter	
INPUTS:	PRE IN / SPEAKER IN
OUTPUTS:	Pre OUT
Filter: Lo-Pass:	50 + 500 Hz @ 24 dB/Oct.
Phase:	(continuous adjustment) 0 + 180°
Subsonic: Hi-Pass	18 + 40 @ 24 dB/Oct.
Remote SUB Volume:	(-50 + 6) dB

Size / Weight	
Max size (mm / in.):	349 x 170 x 46,7 / 13.74 x 6.69 x 1.84
Weight (kg / lb.):	3,09 / 6.81

Technology *Art-Sound*
Manufactured by
elettromedia spa

All Specifications Subject to Change Without Notice

HERTZ

PART OF **ELETTROMEDIA** - 62018 Potenza Picena (MC) Italy - T +39 0733 870 870 - F +39 0733 870 880 - www.elettromedia.it



ML Power QUICK START GUIDE

rev 1.0 a

Il Manuale Utente è disponibile
anche sul nostro sito
www.hertzaudiovideo.com

The User's Manual is also
available on our web site
www.hertzaudiovideo.com

Index

1. PRECAUTIONS	8
2. INSTALLATION AND SIZES	34
3. CABLE SIZE CALCULATION TABLES. A: POWER SUPPLY / B: SPEAKERS	34
4. POWER SUPPLY and REMOTE IN CONNECTION / FUSE REPLACEMENT	35
5. PRE IN / SPEAKER IN / PRE OUT	36
6. AUTO TURN-ON BY SPEAKER IN (without REMOTE IN)	37
7. INSTALLATION EXAMPLES:	38



1. PRECAUTIONS

English / English

Before installing the components, please carefully read all of the instructions contained in this manual. It is advisable to carefully follow the highlighted instructions. Failure to respect these instructions may cause unintentional harm or damage to the components.

SAFETY CONSIDERATIONS

1. Make sure your car has 12 VDC voltage negative ground electric system.
2. Check your alternator and battery condition to ensure they can handle the increased consumption.
3. Do not carry out any installation inside the engine compartment or exposed to water, excessive humidity, dust or dirt.
4. Never run cables outside the vehicle or install the amplifier next to electronic gearcases.
5. Install the amplifier in the vehicle parts where temperature is between 0°C (32°F) and 55°C (131°F). Let the amplifier outer profile be at least 5 cm (2") far from possible walls. There must be good air circulation where the amplifier is installed. If you cover the heat sink, the amplifier goes in protection.
6. The amplifier can reach temperatures of around 80°C (176°F). Make sure it is not dangerously hot before touching it.
7. Periodically clean the amplifier without using aggressive solvents that might damage it. Don't use compressed air, since it would push solid parts in the amplifiers. Dampen a piece of cloth with water and soap, wring it and clean the amplifier. Then use a piece of cloth dampened with water only; eventually clean the amplifier with a dry piece of cloth.
8. Make sure the location you chose for the components does not affect the correct functioning of the vehicle mechanical and electrical devices.
9. Make sure power cable is not short circuited during installation and connection with the battery.
10. Use extreme caution when cutting or drilling the car plate, checking there are no electrical wiring or structural element underneath.
11. When positioning the power supply cable, avoid to run the wire over or through sharp edges or close to moving mechanical devices. Use rubber grommets to protect the wire if it runs in a hole of the plate or proper materials if it is close to heat-generating parts.
12. Make sure all the cables are properly secured all along their length. Also, make sure their outer protective jacket is flame resistant and self extinguishing. Use a clamping screw to secure positive and negative cables just close to the amplifier respective power supply terminal blocks.
13. Choose the cable gauge according to the amplifier power and to the suggestions you can find here. Use high quality cables, connectors and accessories, as you can find in the Connection catalogue.
14. Pre-plan the configuration of your new amplifier and the best wiring routes to ease installation.
15. In order to avoid incidental damage, keep the product in the original packaging until you are ready for the final installation.
16. Always wear protective eyewear when using tools, as splints or product residue may become airborne.

TYPICAL INSTALLATION SEQUENCE

If you have any questions please refer to the Advanced Manual you can find available on www.hertzaudiovideo.com or contact your Hertz dealer or Hertz authorized service for assistance.

1. Before installing the amplifier turn off the source and all other electronic devices in the audio system to prevent any damages.
2. Using a cable with adequate AWG (see chart: Power Supply Cable), run the power wire from the battery location to the amplifier mounting location.
3. Connect the power supply with the correct polarity. connect (+) terminal to the cable coming from the battery and (-) terminal to the car chassis.
4. Put an insulated fuse holder 40 cm max far from the battery positive terminal; connect one end of the power cable to it after connecting the other end to the amplifier. Do not mount the fuse.
5. To ground the device (-) in the right way, use a screw in the vehicle chassis; scrape all paint or grease from the metal if necessary, checking with a tester that there is continuity between the battery negative terminal (-) and the fixing point. If possible, connect all components to the same ground point; this solution rejects most noise which can be generated during the audio reproduction.
6. Route all signal cables close together and away from power cables.
7. Connect the RCA input cables, the applied signal must be between 0.2 VRMS and 5 VRMS.
8. Connect the high level inputs using the proper plug. Applied signal must be between 0.8 VRMS and 20 VRMS. Don't use it if you are already using Pre In preamplified connection.
9. Connect the speaker output using 10 AWG max speaker cable.
10. Don't connect (-) L and (-) R speaker outputs together. If you use an external stereo crossover, make sure that its negative poles are not connected together.
11. The amplifier turns on by connecting the remote turn on terminal (REMOTE IN) to the source specific output. The amplifier turns on automatically, without remote signal, also if using high level inputs (Speaker IN) by setting the "AUTO TURN ON" switch to position ON.
12. The LED on the front panel lights up green indicating that the product is on. The LED lights up red if the outputs go on overload, if the thermal protection is triggered, if the speaker cables short circuit with the vehicle chassis and if the amplifier is malfunctioning.
13. The fuse/s is/are located near the power supply and speaker terminals. To replace, remove the fuse/s from the housing. Always replace the fuse of the same rating.
14. Secure all auxiliary devices you built to install the components to the vehicle structure; this insures stability and safety while driving. The amplifier detachment while driving can seriously damage the people in the vehicle and other cars.
15. When installation is over, check the system's wiring and make sure all connections were done in the right way.
16. Put the fuse into the fuse holder. The fuse value will have to be 30% higher than the amplifier built-in one. In case the cable supplies several amplifiers, the fuse value will have to be 30% higher than the sum of the values of all other fuses in the amplifiers.
17. Listening level calibration is made by adjusting the source volume up to ¾ of its maximum level; then, adjust the amplifier levels until you hear distortion.
18. Warranty Certificate: please check out the Hertz website for further information.

SAFE SOUND

USE COMMON SENSE AND PRACTICE SAFE SOUND. PLEASE REMEMBER THAT LONG EXPOSURE TO EXCESSIVELY HIGH SOUND PRESSURE LEVELS MAY DAMAGE YOUR HEARING. SAFETY MUST BE AT THE FOREFRONT WHILE DRIVING.

**Information on electrical and electronic equipment waste (for those European countries which organize the separate collection of waste)**

Products which are marked with a wheeled bin with an X through it can not be disposed of together with ordinary domestic waste. These electrical and electronic products must be recycled in proper facilities, capable of managing the disposal of these products and components. In order to know where and how to deliver these products to the nearest recycling/disposal site please contact your local municipal office. Recycling and disposing of waste in a proper way contributes to the protection of the environment and to prevent harmful effects on health.

ML Power

2. INSTALLATION AND SIZES

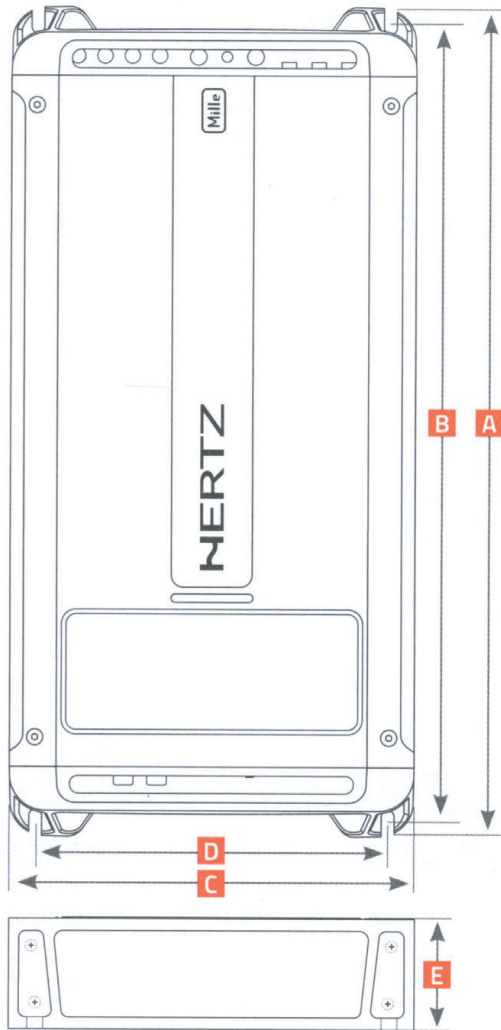

	A	B	C	D	E	
ML POWER 1	349	332	170	148	46.7	mm
	13.74	13.07	6.69	5.82	1.84	in.
ML POWER 4	289	272	170	148	46.7	mm
	11.38	10.7	6.69	5.82	1.84	in.
ML POWER 5	349	332	170	148	46.7	mm
	13.74	13.07	6.69	5.82	1.84	in.

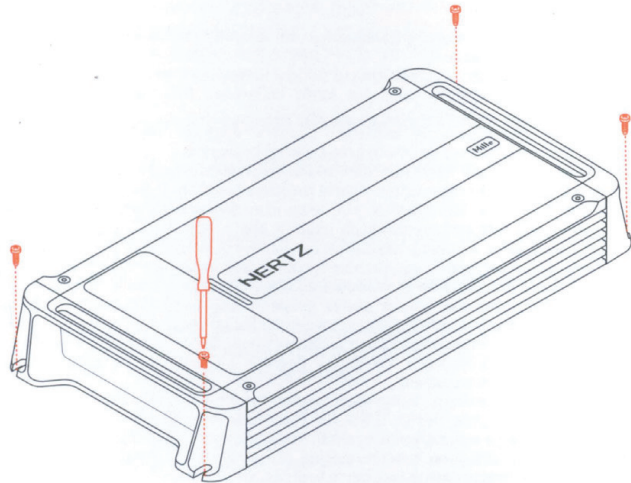

3. CABLE SIZE CALCULATION TABLES: A: Power supply cable / B: Speakers cable

A: Power supply cable

Power & Ground cable calculation table		Cable Size	
Minimum gauge size recommended for MAINPOWER & POWER FLOW cables. MAINPOWER cables ensure higher instantaneous current transfer.		AWG.	mm ²
240-350		1/0	53,5
180-240		2	33,6
150-180		4	21,2
120-150		8	8,4
100-120		10	5,3
80-100		12	3,3
60-80		14	2,1
40-60		16	1,3
20-40		18	0,8
8-20			
0-8			

*Current Draw I (A)	0-1	1-2	2-3	3-4	4-5	5-6	6-7	7-8
240-350								
180-240								
150-180								
120-150								
100-120								
80-100								
60-80								
40-60								
20-40								
8-20								
0-8								

Cable length (m)

B: Speakers cable

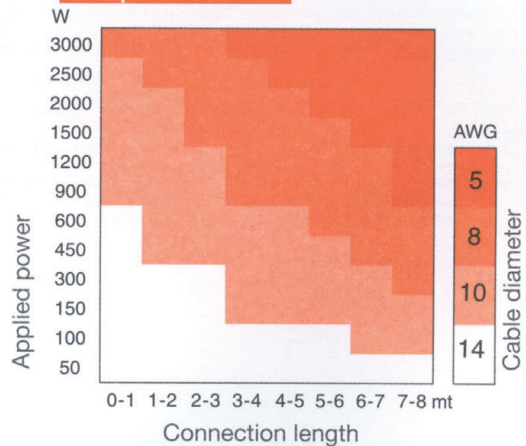

4. POWER SUPPLY and REMOTE IN CONNECTION / FUSE REPLACEMENT

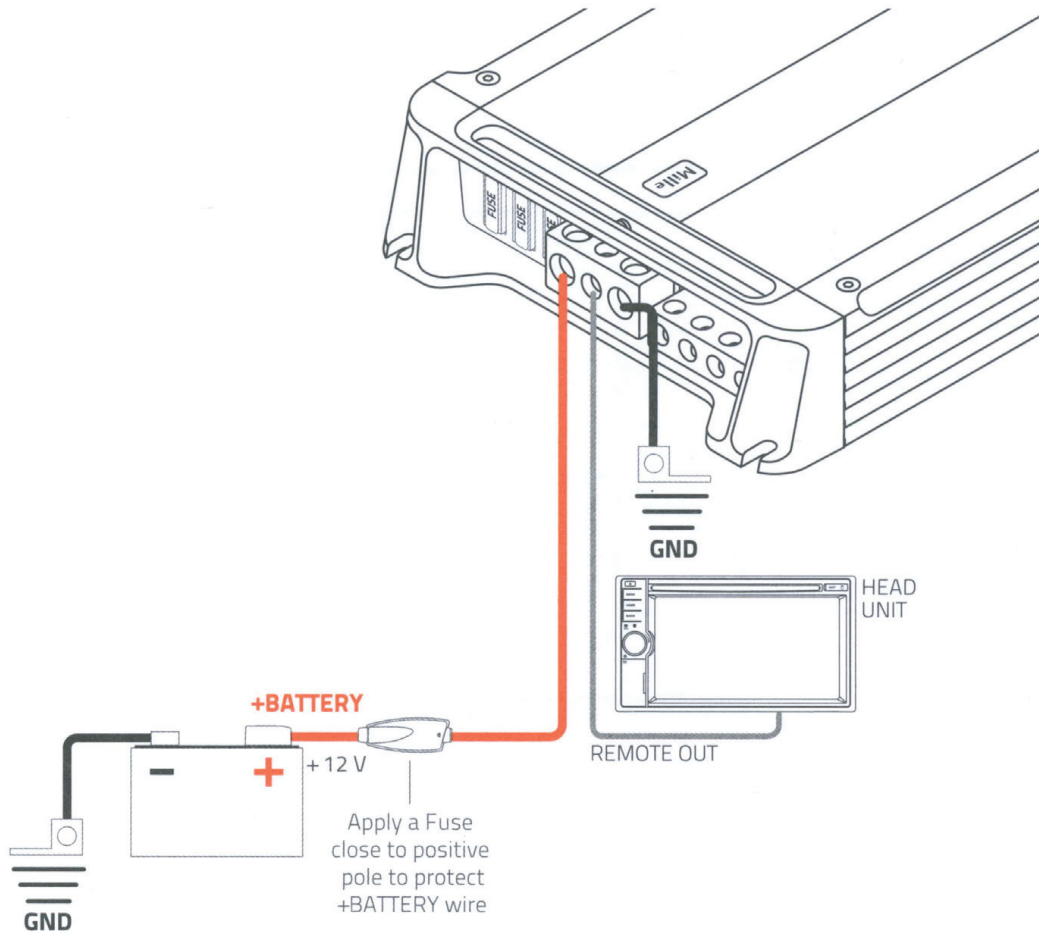

MODEL	FUSE
ML POWER 1	3 x 40 A
ML POWER 4	2 x 40 A
ML POWER 5	2 x 40 A

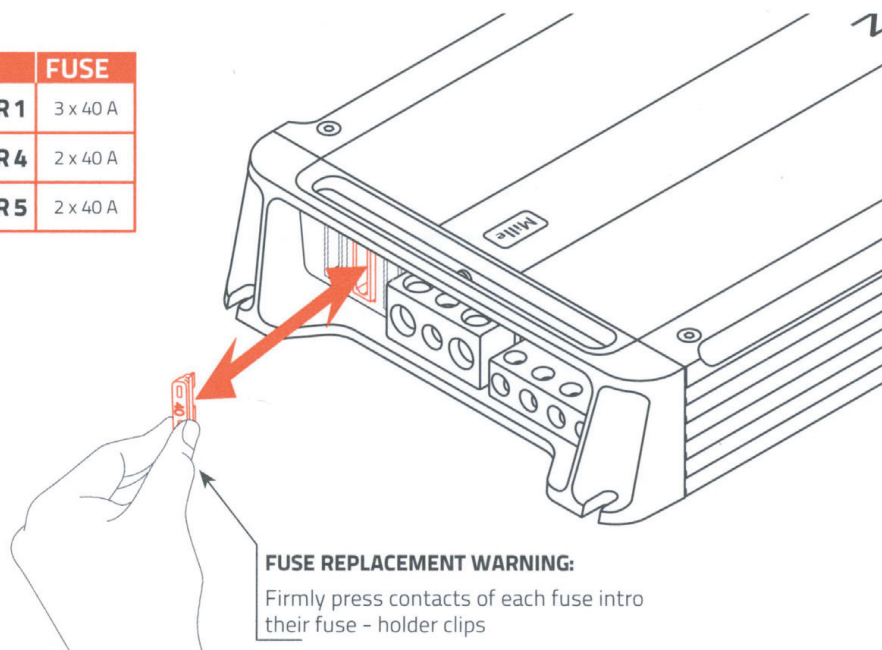

ML Power

5. PRE IN / SPEAKER IN / PRE OUT

PRE INPUTS

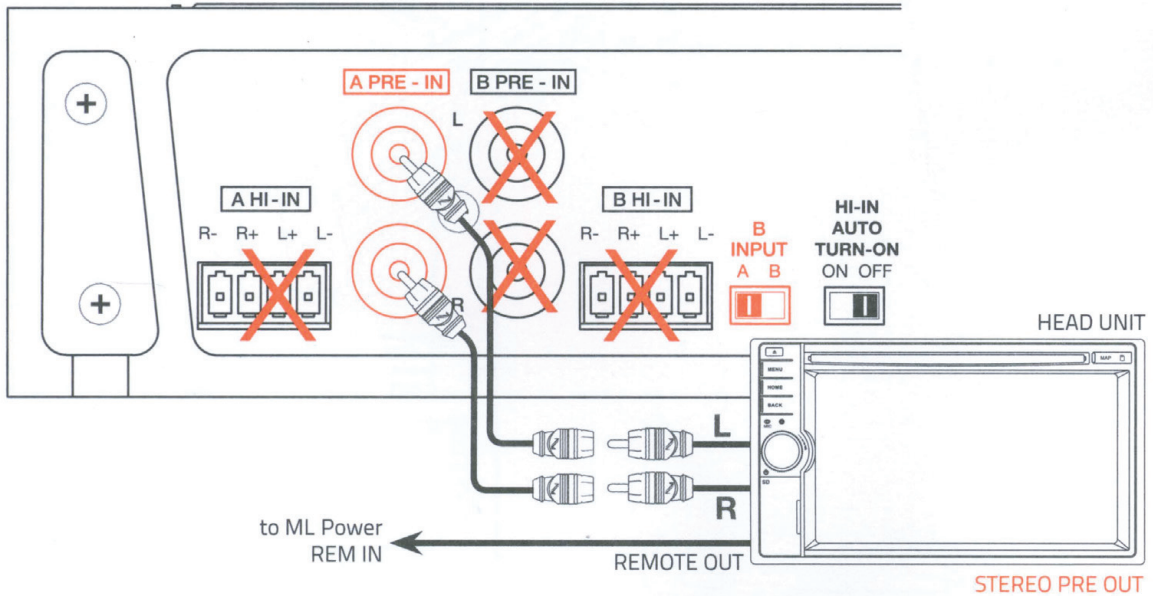

HI LEVEL INPUTS

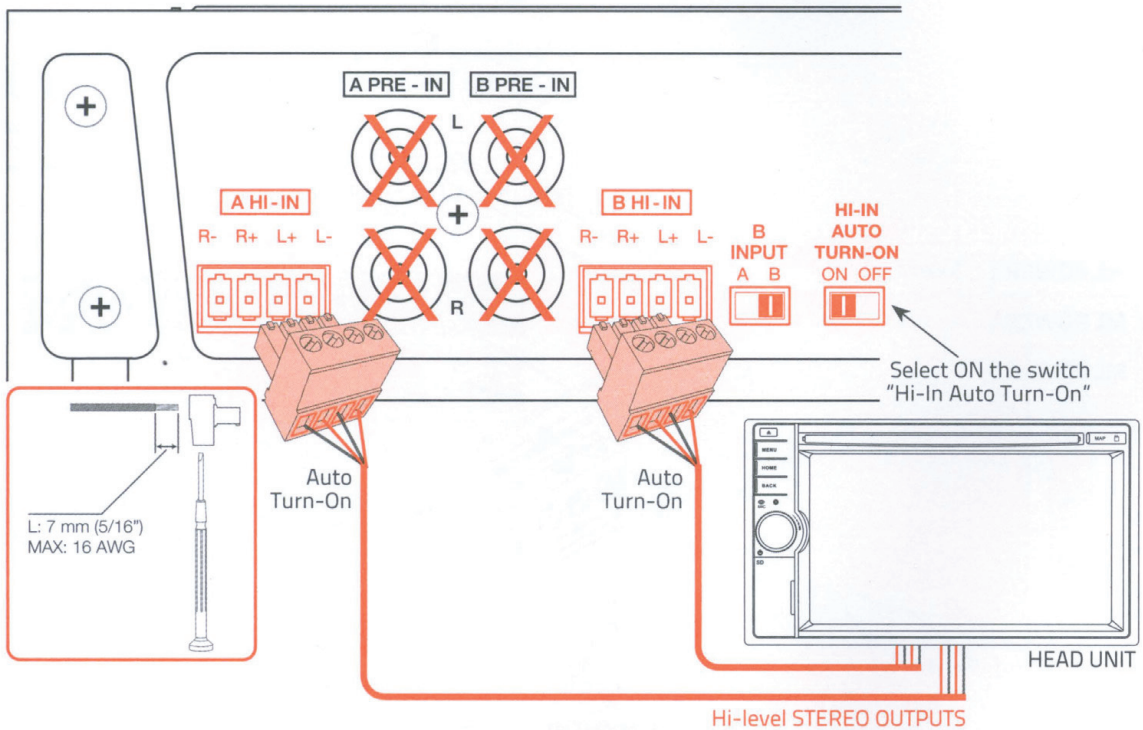

X	Not AVAILABLE	○ — □	Set-up CONTROLS	○ — □	Adjustment CONTROLS
---	---------------	-------	-----------------	-------	---------------------

6. AUTO TURN ON BY SPEAKER IN (without REMOTE IN)

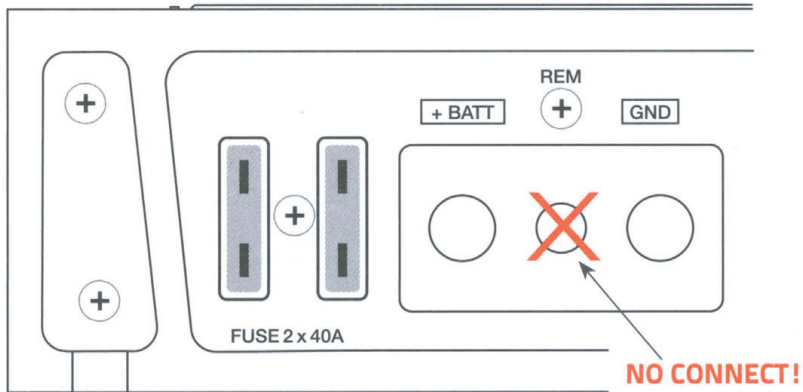
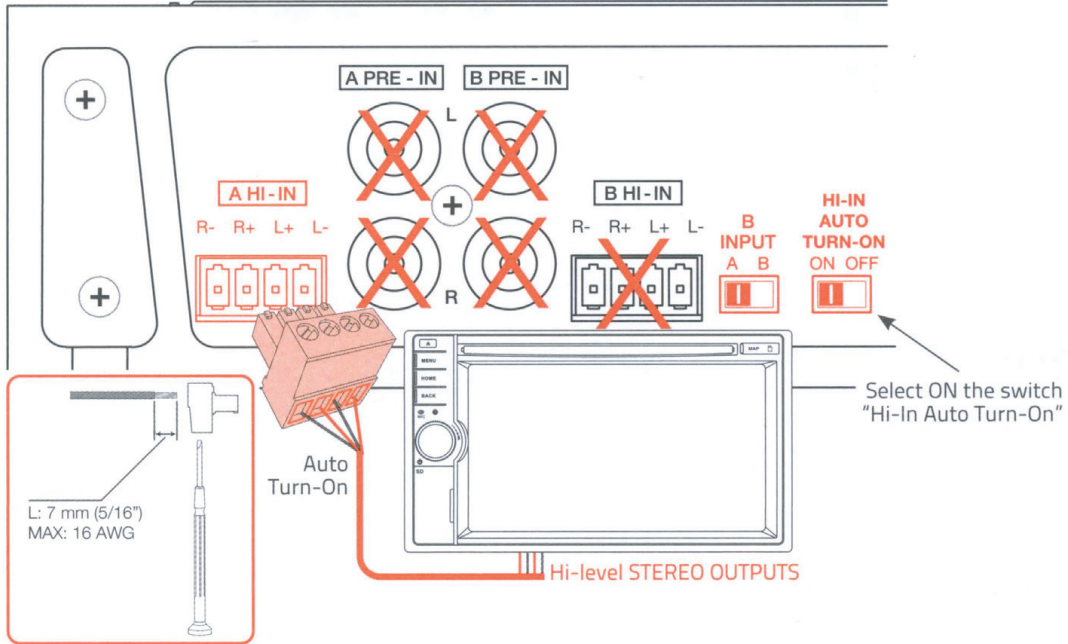

X Not AVAILABLE
 ○ - □ Set-up CONTROLS
 ○ - □ Adjustment CONTROLS

7. INSTALLATION EXAMPLES

ML POWER 1

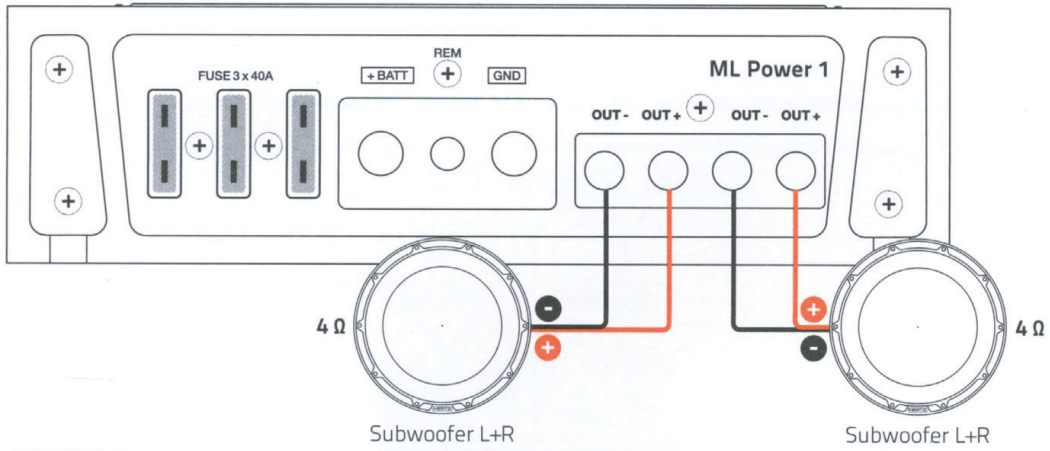

ML POWER 4

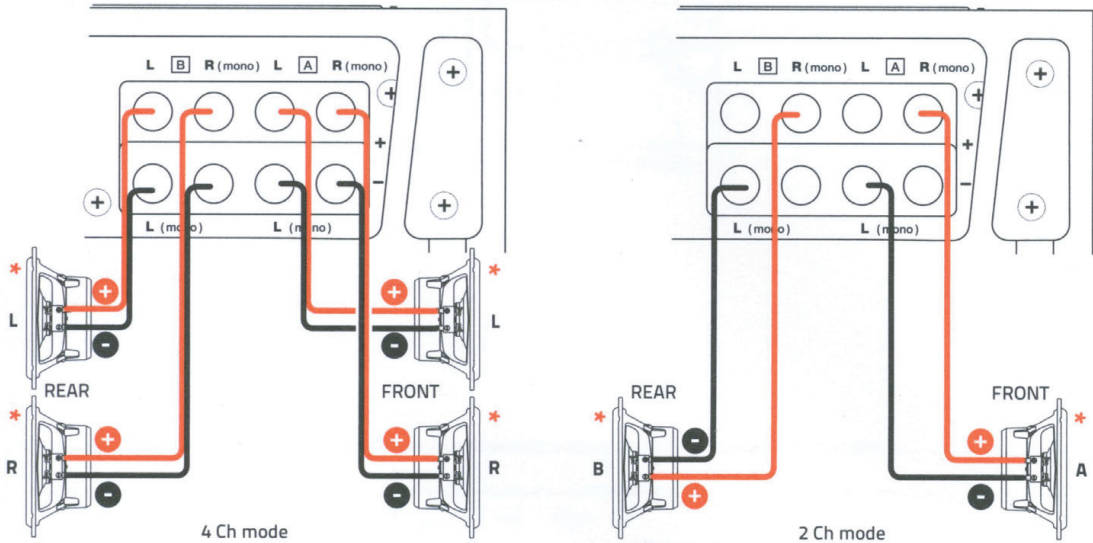

* Coaxial speakers

ML POWER 5

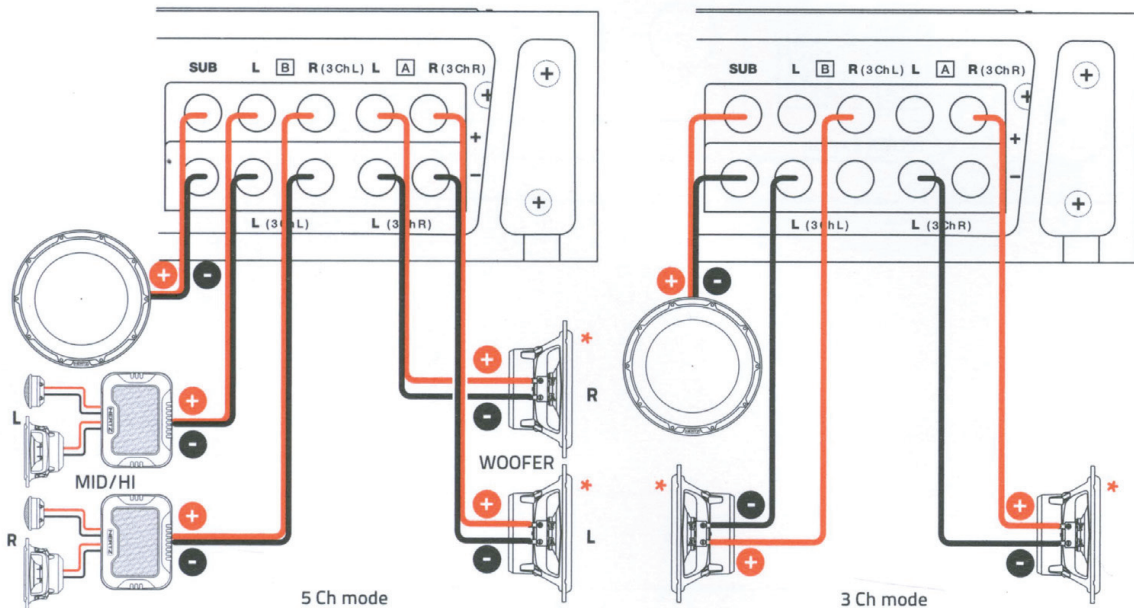

* Coaxial speakers

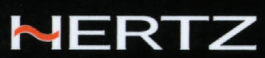

POWER ML POWER 1

D-CLASS MONO AMPLIFIER

1000 W

ADC
ADVANCED D-CLASS



HRC BM (optional)

POWER SUPPLY

Power supply voltage:	11÷15 VDC
Idling current:	2 A
Idling current when off:	0.04 mA
Consumption @ 1Ω, 14.4 VDC (Max Musical Power):	83.5 A

AMPLIFIER STAGE

Distorsion - THD (100 Hz @ 4Ω):	0.08 %
Bandwidth (-3 dB):	18 ÷ 500 Hz
S/N Ratio (A weighted @ 1 V):	105 dB
Damping factor (100 Hz @ 4Ω):	100
Pre-In sensitivity:	0.2 ÷ 5 V RMS
Pre-In impedance:	15 kΩ
Speaker-In sensitivity:	0.8 ÷ 20 V RMS
Speaker-In impedance:	470 Ω
Load impedance: 1 Ch	4 ÷ 1Ω

CEA 2006-A RATINGS

RMS Power (4 Ω, ± 1 % THD+N, 14.4 V):	600 W x 1Ch
S/N Ratio (ref. 1 W output):	83,5 dBA



OUTPUT POWER (RMS) @ 14.4 VDC, THD 1%:

1 Ch	600 W x 1 (4Ω)
1 Ch	1000 W x 1 (2Ω)
1 Ch	1000 W x 1 (1Ω)

OTHER FUNCTIONS

Remote In:	4 ÷ 15 VDC - 1 mA
ART™:	Automatic Remote Turn-On/Off with Speaker-In
Fuse:	3 x 40 A

1. ADC (ADVANCED D-CLASS TECHNOLOGY) ensures hi-end acoustic response with unmatched power efficiency;
2. Thermally optimized double extruded heat sink featuring die-cast aluminium ergonomic terminals;
3. Stable at 1Ω to drive safely Mille subwoofers;
4. Optional HRC BM for subwoofer volume control;
5. 24 dB/Oct. continuously adjustable (50 to 500Hz) Lo-Pass filters and 24dB/Oct. subsonic filter (18 to 40Hz);
6. Variable phase control with 0-180° continuity to optimize low frequencies;
7. ML Power IN with balanced Speaker In inputs for an increased noise rejection and RCA In;
8. Operating status real time monitoring through 4 LEDs ;
9. Pre-out full range outputs also available with Speaker In inputs;
10. ART™ (Automatic Remote Turn On-Off).

INPUTS / FILTERS

Inputs:	Pre IN / Speaker IN
Outputs:	Pre OUT
Filters: Lo-pass	50 ÷ 500 Hz @ 24 dB/Oct.
Phase:	(continuous adjustment) 0 ÷ 180°
Subsonic: Hi-pass	18 ÷ 40 Hz @ 24 dB/Oct.
Remote SUB Volume:	(-50 ÷ 6) dB

FILTER CONFIG.

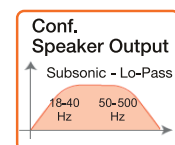

SIZE / WEIGHT

Max size (mm/inches):	170 x 349 x 46.70 6.69" x 13.74" x 1.84"
Weight (kg/lb):	3.09 / 6.81

Modello Model Modell Modèle Modelo Модель 型号

N° Serie - Serial Number
Seriennummer
Numéro de série - N° Serie
Серийный номер - 序列号

Data acquisto - Date of
purchase - Kaufdatum Date
de l'achat - Fecha de Compra
Дата покупки - 购买日期

Nome dell'acquirente - Purchaser's name - Name
des Käufers - Nom de l'acheteur Datos del comprador
Имя покупателя - 用户姓名

Indirizzo - Address - Anschrift - Adresse - Domicilio - Адрес - 地址

C.A.P. - Zip Code - Postleitzahl
Code Postal - C.P. - Почтовый
индекс - 邮编

Tel. - Phone - Tel. - Tél.
Telefono - Телефон - 电话

Timbro Rivenditore - Dealer's Mark - Stempel des Händlers
Cachet du revendeur - Sello del Reevendedor
Штамп распространителя - 经销商标志

Firma - Signature - Unterschrift - Signature - Firma - Подпись - 签名

Certificato di garanzia

Warranty certificate

Garantieschein

Certificat de garantie

Certificado de garantia

Гарантийный сертификат

保修卡

WARRANTY

WWW.HERTZAUDIOVIDEO.COM

HERTZ

Declared defect _____

For technical service's use only _____

Repaired on _____

Repaired by _____

Defect _____

Warranty

Yes

No

Declared defect _____

For technical service's use only _____

Repaired on _____

Repaired by _____

Defect _____

Warranty

Yes

No

Hertz products are warranted for the period fixed by current laws, under normal functioning conditions, against defects concerning materials or their manufacturing.

Warranty is valid from the date of purchase, certified by receipt.

Warranty is not valid if:

- the product is damaged by incidents, installations and inadequate use or by any causes not depending on materials or manufacturing defects;
- the product is modified or tampered by unauthorised people;
- its serial number is disguised or cancelled.

When the product is under warranty, its manufacturer will decide whether to repair or replace its defective parts. The faulty product must be taken to the retailer where it was purchased, by showing the warranty certificate completely filled in.

In case the product is no longer under warranty, it will be repaired at current costs.

We don't assume liabilities for damages due to transport. We are not responsible for: costs or loss of profits due to impossibility of using the product, other accidental or possible costs, expenses or damages met by the customer.

Warranty according to effective laws.