

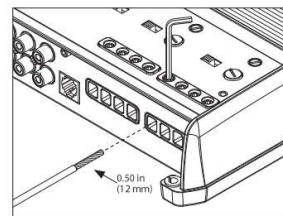

XDM400/4

400W 4-CHANNEL AMPLIFIER

OWNER'S MANUAL
MANUEL D'UTILISATION
MANUAL DEL PROPIETARIO
BEDIENUNGSANLEITUNG
MANUALE DEL PROPRIETARIO

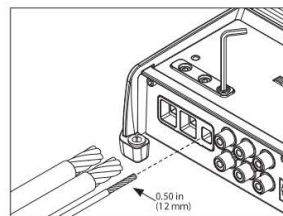
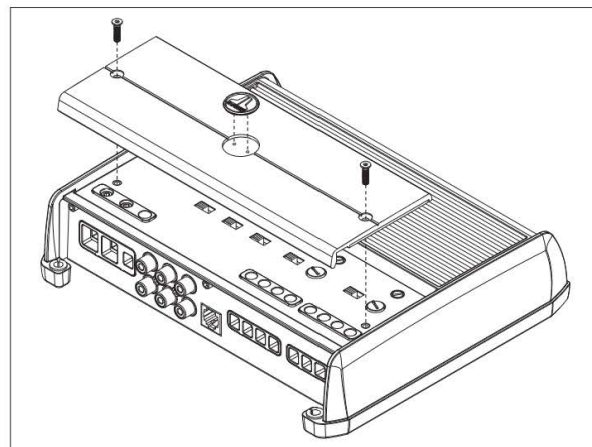
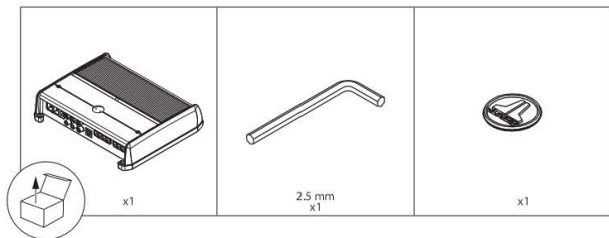

INSTALLATION CONSIDERATIONS

- Installation requires appropriate tools and safety equipment. Professional installation is recommended.
- This product is water-resistant. Do not submerge or subject to high-pressure water spray.
- Before installation, turn off the audio system and disconnect the battery system from the audio system.
- When possible, install in a dry, well-ventilated location that does not interfere with factory-installed systems. If a dry environment is not available, a location that is not exposed to heavy splashing may be used.
- Do not install in the engine compartment, any areas of extreme heat or where it will be directly exposed to the elements.
- Before cutting or drilling, check for potential obstacles behind mounting surfaces.
- Carefully route all system wiring away moving parts and sharp edges; secure with cable ties or wire clamps and use grommets and loom where appropriate to protect from sharp edges.

SAFETY CONSIDERATIONS

- Only use this product with 12 volt, negative-ground electrical systems. This product is not certified or approved for use in aircraft.
- Mount this product securely to prevent damage or injury in severe conditions.
- An appropriate fuse (or circuit breaker) at the main power wire is vital for vehicle/vessel safety and must be installed within 18 inches (45 cm) of the positive battery connection.
- For ABYC and NMEA applications, circuit protection is required within 7 inches (18 cm) of the battery, unless the cable is in an enclosure or conduit.
- Listen to your audio system at levels appropriate for operating conditions and hearing safety.

CONNECTIONS

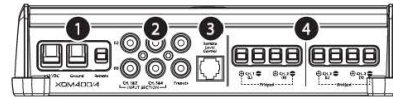

| | Connection | Description | Notes | |
|---|--------------------------|---|--|---|
| 1 | +12VDC | Positive (+12V) Power Connection | <ul style="list-style-type: none"> • 4 AWG wire (8 AWG minimum) • Install 40A fuse at (+) battery post | |
| | Ground | Negative (GND) Ground Connection | <ul style="list-style-type: none"> • 4 AWG wire (required) | |
| | Remote | Positive (+12V) Activation Connection | <ul style="list-style-type: none"> • 18 – 12 AWG wire capacity • See 1 Turn On Mode for more info | |
| 2 | CH. 1 Input | Left Input Signal, Black RCA | <ul style="list-style-type: none"> • Accepts 200mV – 4V input voltage • See 2 Input Mode for more info | |
| | CH. 2 Input | Right Input Signal, Red RCA | | |
| | CH. 3 Input | Left Input Signal, Black RCA | | |
| | CH. 4 Input | Right Input Signal, Red RCA | | |
| | Preout 1 | Left Pass-Through Preamp Signal, Black RCA | <ul style="list-style-type: none"> • See 2 Preouts From for more info | |
| | Preout 2 | Right Pass-Through Preamp Signal, Red RCA | | |
| 3 | Remote Level Control | Remote Level Controller Connection (optional) (HD-RLC or MHD-RLC) | <ul style="list-style-type: none"> • Operates as an attenuator only: Fully counter-clockwise = Level Muted Fully clockwise = Level Unaffected | |
| 4 | CH. 1 (L) Speaker Output | (+) Positive Speaker Output | CH. 1&2 Bridged (+) | <ul style="list-style-type: none"> • Minimum impedance load: Stereo mode >2 ohms Bridged mode 24 ohms • 16 – 8 AWG wire capacity |
| | | (-) Negative Speaker Output | | |
| | CH. 2 (R) Speaker Output | (+) Positive Speaker Output | CH. 1&2 Bridged (-) | |
| | | (-) Negative Speaker Output | | |
| | CH. 3 (L) Speaker Output | (+) Positive Speaker Output | CH. 3&4 Bridged (+) | |
| | | (-) Negative Speaker Output | | |
| | CH. 4 (R) Speaker Output | (+) Positive Speaker Output | CH. 3&4 Bridged (-) | |
| | | (-) Negative Speaker Output | | |

CONTROLS

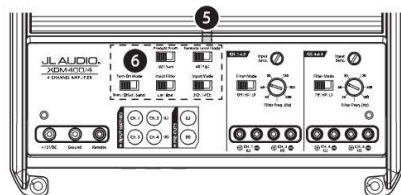

| | Control (Function) | Setting | Description |
|---|---|---|---|
| 5 | Status LED (indicates operating status) | Flashing Green | Amplifier Powering Up, Audio Output Muted |
| | | Green | On-Normal Operation, Active Audio Output |
| | | Red | On-Safe Mode, Over-Temperature Condition, Audio Output Reduced • Reverts to normal operation when temperature returns to a safe level |
| | | Amber (yellow) | On-Safe Mode, Over-Current Condition, Audio Output Muted • May exhibit repetitive, audible ticking or thumping noise in the output • Inspect for speaker/wire short circuit or low impedance |
| | | LEDs Off | Amplifier Turns Off (unexpectedly), Low-Voltage Condition • Occurs when battery or remote turn-on voltage drops below 10V • Reverts to normal operation when voltage rises above 11V |
| 6 | Turn On Mode (configures activation method) | Remote | +12V Remote Turn-On (Preferred) • Controlled by a switched +12V circuit or turn-on output of your source unit/OEM interface |
| | | Offset | DC Offset-Sensing (Automatic) • Turns On by detecting the presence of small DC signal in OEM audio outputs and turns Off after the signal is removed • Designed for high-level (speaker) signals only • Detects input signal from CH. 1 (L) only |
| | | Signal | Signal-Sensing (Automatic) • Turns On by detecting full-range OEM audio signals and turns Off after the signal is removed (within 30 seconds) • Using DC Offset or Signal Sensing methods will turn the "Remote" terminal into a +12V turn-on output. |
| | Input Filter (configures input filter application) | Car | Select for most installations (automotive or marine) |
| | | Boat | Select if experiencing interference from high-current mechanical switches/devices |
| Input Mode (configures input signal connections) | 2 Ch. | Select when using CH. 1&2 inputs only • CH. 3 will operate with CH. 1 signal • CH. 4 will operate with CH. 2 signal | |
| | 4 Ch. | Select when using all four inputs | |
| Remote Level Mode (configures HD-RIC operation - optional) | All | Adjusts level of all channels equally | • Multiple amplifiers can be controlled from a single HD-RIC, using a non-duplex phone line splitter and multiple phone cables. |
| | 3-4 | Adjusts level of channels 3 & 4 only | |
| Preouts From (configures preamp output signals) | 1&2 | Same signal that is connected to CH. 1&2 inputs | |
| | Sum | Summed signal, combining CH. 1&3 and CH. 2&4 inputs into a stereo signal pair | |

CONTROLS

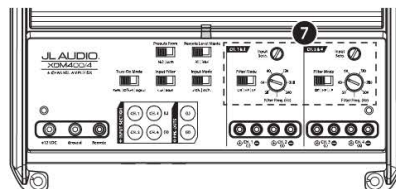

| | Control (Function) | Setting | Description |
|---|---|---|--|
| 7 | Input Sens. (adjusts each channel pair's input stage) | Variable | Use to match the source unit's output voltage with the inputs of each pair of amplifier channels. See Appendix A for detailed information. |
| | | Off | Filter defeated; passes full range of frequencies present at the inputs |
| | CH. 1&2 Filter Mode (configures the filter of CH. 1&2) | HP | Attenuates frequencies below the CH. 1&2 "Filter Freq. [Hz]" dial, at a rate of 12dB/octave |
| | | LP | Attenuates frequencies above the CH. 1&2 "Filter Freq. [Hz]" dial, at a rate of 12dB/octave |
| | CH. 1&2 Filter Freq. (Hz) (adjusts filter cutoff frequency) | Variable | Use to adjust the cut off frequency of channel 1&2's active filter, from 50 Hz – 500 Hz / 12dB per octave |
| | | Off | Filter defeated; passes full range of frequencies present at the inputs |
| CH. 3&4 Filter Mode (configures the filter of CH. 3&4) | HP | Attenuates frequencies below the CH. 3&4 "Filter Freq. [Hz]" dial, at a rate of 12dB/octave | |
| | LP | Attenuates frequencies above the CH. 3&4 "Filter Freq. [Hz]" dial, at a rate of 12dB/octave | |
| CH. 3&4 Filter Freq. (Hz) (adjusts filter cutoff frequency) | Variable | Use to adjust the cut off frequency of channel 3&4's active filter, from 50 Hz – 500 Hz / 12dB per octave | |

EN

APPENDIX A:

Input Sensitivity Level Setting

Follow the steps below to adjust the input sensitivity of each amplifier channel pair to achieve overall system balance.

| Necessary Equipment | |
|---|--|
| <ul style="list-style-type: none"> Digital AC Voltmeter Sine-wave test tone recorded at 0 dBfs reference level in the frequency range to be amplified. Do not use attenuated test tones (-10 dB, -20 dB, etc.). Full range channel/amplifier applications: 1 kHz Subwoofer channel/amplifier applications: 50 Hz Depending on your type of source unit, the sine-wave may be played via a CD, USB thumb drive, portable media player or Bluetooth® audio source. Make sure to disable any EQ/DSP modes on your portable media player during level setting. | |
| The Nine-Step Procedure | |
| 1. | Disconnect the speaker(s) from the amplifier's speaker output connectors. |
| 2. | Turn off all processing (bass/treble, loudness, EQ, etc.) on the source unit, processors (if used) and amplifier. Set the fader control to center position and the subwoofer level control to 3/4 of maximum, if used. |
| 3. | Turn all "Input Sens." controls all the way down. |
| 4. | Set the source unit volume to 3/4 of full volume. This will allow for reasonable gain overlap with moderate clipping at full volume. |
| 5. | Using the chart below, determine the target voltage for input sensitivity adjustment according to the nominal impedance of the speaker system connected to the amplifier outputs. |
| 6. | Verify that you have disconnected the speakers before proceeding. Play a track with an appropriate sine wave (within the frequency range to be amplified) at 3/4 source unit volume. |
| 7. | Connect the AC voltmeter to the speaker output terminals of the amplifier. If the channel pair is operating in stereo, it is only necessary to measure one channel. If bridged, make sure you test the voltage at the correct terminals (L+ and R-). |
| 8. | Increase the "Input Sens." control until the target voltage is observed with the voltmeter. |
| 9. | Once you have adjusted each channel section to its maximum low-distortion output level, reconnect the speaker(s). The "Input Sens." controls can now be adjusted downward if the amplifier requires attenuation to achieve the desired system balance. |
| IMPORTANT! | |
| <ul style="list-style-type: none"> Do not increase any "Input Sens." setting for any amplifier channel or channel pair in the system beyond the maximum level established during this procedure. Doing so will result in audible distortion and possible speaker damage. It will be necessary to re-adjust the "Input Sens." if any equalizer boost is activated after setting the "Input Sens." with this procedure. This applies to any EQ boost circuit, including source unit tone controls or EQ circuits. EQ cuts will not require re-adjustment. | |

| Nominal Impedance | Target AC Voltage | |
|-------------------|-------------------|-----------------|
| | Stereo | Bridged |
| 8Ω | 17.3 V | 34.6 V |
| 4Ω | 17.3 V | 28.2 V |
| 2Ω | 14.1 V | not recommended |

SPECIFICATIONS

| Amplifier Section | | |
|--|--|---------------------------------------|
| Amplifier Topology | NexD™ Ultra-High Speed Class D | |
| Power Supply Type | Unregulated MOSFET Switching | |
| Minimum Copper Power/GND Wire | 8 AWG (Note: CCA/Copper Clad Aluminum wire is not recommended.) | |
| Recommended Fuse | 40 A | |
| Rated RMS Power @ 14.4V, <1% THD+N | 75W x 4 @ 4 Ω | 100W x 4 @ 2 Ω |
| | 150W x 2 @ 8 Ω Bridged | 200W x 2 @ 4 Ω Bridged |
| Rated RMS Power @ 12.5V, <1% THD+N | 60W x 4 @ 4 Ω | 90W x 4 @ 2 Ω |
| | 120W x 2 @ 8 Ω Bridged | 180W x 2 @ 4 Ω Bridged |
| Frequency Response | 12 Hz – 22 kHz (+0, -1dB) | |
| S/N Ratio (A-weighted, 20 Hz–20 kHz noise bandwidth) | >104 dB (Referred to rated power), >84 dB (Referred to 1W) | |
| | Damping Factor | >150 / 50 Hz @ 4 Ω, >75 / 50 Hz @ 2 Ω |
| Input Section | | |
| Number of Inputs | 4 (Two Stereo Pairs) | |
| Input Type | Differential-Balanced with RCA Jack inputs | |
| Input Voltage Range | 200mV – 4V RMS | |
| Signal Processing | | |
| Filter Type | CH. 1&2 | CH. 3&4 |
| | Active, 12dB/octave, High-Pass or Low-Pass (50 – 500 Hz), defeatable | |
| Remote Level Control | HD-RLC or MHD-RLC (optional). Full mute to 0 dB range. | |
| Dimensions | | |
| L x W x H | 8.52 in. x 7.09 in. x 2.05 in. (217 mm x 180 mm x 52 mm) | |

EN

Due to ongoing product development, all specifications are subject to change without notice.





WARRANTY INFORMATION
CAR AUDIO



SKU#011570
©2021 JL Audio, Inc.

USA Limited Warranty

FOR CAR AUDIO PRODUCTS SOLD AT RETAIL:

JL Audio warrants these products to be free of defects in materials and workmanship from the original date of purchase for these periods:

One (1) year from the original date of purchase: Car Speakers and Subwoofers

Two (2) years from the original date of purchase: Car Amplifiers, Electronics, Enclosed Subwoofers, Stealthbox and Connection Products

Note: The Car Amplifier Warranty Period is extended to three (3) years when accompanied with the purchase of a qualifying JL Audio Amplifier Power Connection System and with installation by an authorized JL Audio dealer.

This warranty is not transferable and applies only to the original retail purchaser from an authorized JL Audio dealer in the USA. Should service be necessary under this warranty for any reason due to manufacturing defect or malfunction, JL Audio will (at its discretion), repair or replace the defective product with new or remanufactured product at no charge.

Note: Products purchased from unauthorized dealers are not covered under warranty.

Damage caused by the following is not covered under warranty: accident, misuse, physical abuse, product modification or neglect, failure to follow installation instructions, unauthorized repair attempts, misrepresentations by the seller. Loudspeakers with thermal or over-excursion damage are not covered under warranty. This warranty does not cover incidental, accidental or consequential damages and does not cover the cost of removing or reinstalling products. Cosmetic damage due to improper handling, accident or normal wear and tear or exposure to harsh chemicals is not covered under warranty. JL Audio will not be responsible for restoring or maintaining custom finishes or cosmetic treatments applied to products.

This warranty is void if the product's serial number has been removed, altered or defaced.

Any applicable implied warranties are limited in duration to the period of the express warranty as provided herein beginning with the date of the original purchase at retail, and no warranties, whether express or implied, shall apply to this product thereafter. Some states do not allow limitations on implied warranties, therefore these exclusions may not apply to you. This warranty gives you specific legal rights, and you may also have other rights which vary from state to state.

If you need service on your JL Audio product:

All USA retail warranty returns should be sent to JL Audio freight prepaid through an authorized JL Audio dealer and must be accompanied by proof of purchase (a copy of the original retail sales receipt.) Direct returns from consumers or non-authorized dealers will be refused unless specifically authorized by JL Audio with a valid return authorization number. Warranty expiration on products returned without proof of purchase will be determined from the manufacturing date code. Coverage may be invalidated as this date is prior to purchase date. Return only defective components. (If one speaker fails in a system, return only that speaker component, not the entire system.) Non-defective items received will be returned freight-collect. Customer is responsible for shipping charges and insurance in sending the product to JL Audio. Freight damage on returns is not covered under warranty.

JL Audio Customer Service:

1-954-443-1100

9:00 AM – 5:00 PM (Eastern Time Zone)

JL Audio Technical Support:

www.jlaudio.com/support

Original Equipment Warranty

For JL Audio products installed as original equipment by a boat or vehicle manufacturer, warranty coverage is provided within the boat or vehicle manufacturer's warranty program. Please contact your boat dealer or manufacturer.

International Warranty

JL Audio Car Audio products are warrantied against defects in materials and workmanship for a minimum time period as stated in the USA warranty above, beginning on the date of purchase from a Dealer authorized by a JL Audio Distributor. The warranty is only valid within the country of purchase and products are covered by each country's JL Audio Distributor warranty program. To find your country's Distributor please visit this link: www.jlaudio.com/pages/dealer-locator

Consumers in the EEA countries and the Russian Federation are protected by local consumer law and benefit from local statutory warranties.

JL Audio reserves the right to change or modify any of the terms and conditions contained in this Warranty Statement, at any time and in our sole discretion. Any changes or modification will be effective immediately upon posting of the revisions on the JL Audio website at www.jlaudio.com/warranty, and you waive any right you may have to receive specific notice of such changes or modifications.