

DMX958XR DMX908S DMX9708S

MONITOR WITH RECEIVER INSTRUCTION MANUAL

JVCKENWOOD Corporation

- Updated information (the latest Instruction Manual, system updates, new functions, etc.) is available from <https://www.kenwood.com/cs/ce/>.
- The Instruction manual is subject to change for modification of specifications and so forth. Be sure to download the latest edition of the Instruction manual for reference. <https://www.kenwood.com/cs/ce/>



Take the time to read through this instruction manual.

Familiarity with installation and operation procedures will help you obtain the best performance from your new receiver.

For your records

Record the serial number, found on the top of the unit, in the spaces designated on the warranty card, and in the space provided below. Refer to the model and serial numbers whenever you call upon your KENWOOD dealer for information or service on the product.

Model DMX958XR / DMX908S / DMX9708S Serial number _____

US Residence Only

Register Online

Register your KENWOOD product at www.kenwood.com/usa/

Important Notice on Software

Software License on This Product

The software embedded in this product comprises a number of independent software components, each of which is copyrighted by JVCKENWOOD Corporation or by a third party. This product uses software components that are based on an End-User License Agreement (hereinafter called "EULA") stipulated by JVCKENWOOD Corporation and by third parties. The EULA dictates the availability of the source codes of free-software components as a prerequisite to distributing them in executable form under the terms of the GNU General Public License or the Lesser General Public License (hereinafter called "GPL/LGPL"). To get information about the software components that are subject to the terms of the GPL/LGPL, please visit the following Website:

Website URL <https://www2.jvckenwood.com/gpl/>

Queries concerning the contents of the source code or the like will not be accepted.

Please note that software components based on a EULA that is not subject to the terms of the GPL/LGPL or those that have been developed or created by JVCKENWOOD Corporation will be excluded from the scope of source code disclosure.

Because licenses to use software components distributed under the GPL/LGPL are offered to the customers for free of charge, no warranty is granted to the customers, whether explicitly or implicitly, to the extent of the applicable laws. Unless otherwise stipulated by the applicable laws or agreed upon in writing, the copyright holders or those who are entitled to modify and redistribute the software components are not held responsible for any and all damages resulting from their use or from inability to use them. For more information about the terms of use of the software components, required items of compliance and so on, please refer to the GPL/LGPL.

Customers wishing themselves to use a software component that is subject to the GPL/LGPL embedded in this product are encouraged to read the terms of the corresponding license before use. Because each individual license is prescribed by a third party other than

JVCKENWOOD Corporation, the original (English) of the license is presented.

EULA

Software License Agreement

JVCKENWOOD Corporation (hereinafter called "Licensor") holds either the copyright to the embedded software or the right to sublicense it. This agreement establishes the conditions under which the customer uses this "Licensed Software." The customer shall agree to the terms of this license agreement before proceeding to use Licensed Software.

This agreement is deemed to have taken effect when the customer (hereinafter called "User") has used a product implementation of Licensed Software.

The Licensed Software may contain software Licensor has been licensed to use by third parties directly or indirectly. Some third parties may have terms of use prescribed for their customers, apart from this Software License Agreement. This agreement does not apply to such software. Be sure to consult "Important Notice on Software" as presented separately.

Article 1 (General)

Licensor grants to User a non-exclusive, non-assignable right of use Licensed Software within the country where the User purchases the Product (hereinafter the "Country") (except for the exception provided for in Paragraph 1, Article 3).

Article 2 (Right of Use)

1. The rise of use granted under this agreement is the right to use Licensed Software in this product.
2. User may not duplicate, copy, modify, add to, translate or otherwise alter, or loan licensed Software and the associated literature in whole or in part.
3. Use of Licensed Software is limited to a private extent, and Licensed Software may not be distributed, licensed or sublicensed for any purposes whatsoever, including commercial use.
4. User shall use Licensed Software as per the instruction manual or instructions given in the help file and may not use or duplicate data in violations of the regulations of the Copyright Law or other governing laws by using Licensed Software in whole or in part.

Article 3 (Terms of License)

1. In assigning this product, User may not retain the original copy of the embedded Licensed Software (including associated literature, updates and upgrades) and any duplicates and associated literature with regard to the license to use Licensed Software. User may transfer Licensed Software only to the condition of binding the assignee to abide by the terms of this Software License Agreement.
2. User may not reverse-engineer, disassemble, decompile or otherwise analyze the source code of Licensed Software.

Article 4 (Rights to Licensed Software)

All rights to Licensed Software and the associated literature, including copyrights, shall reside with Licensor or the original right holder who has granted the Right of Use and right to sublicense to Licensor (hereinafter referred to as "Original Right Holder"), and User does not have any rights other than Right of Use granted hereunder with regard to Licensed Software and the associated literature.

Article 5 (Exemption Granted to Licensor)

1. Licensor and Original Right Holder do not assume any responsibility for damages caused to User or third parties resulting from the exercise by User of the license granted hereunder, unless otherwise provided by any law to the contrary.
2. Licensor does not warrant Licensed Software to be merchantable, compatible and fit for specific purposes.

Article 6 (Responsibility for Third Parties)

If disputes over the infringement of third parties' intellectual property rights, such as copyrights and patent rights, arise out of the use of Licensed Software by User, User shall resolve these disputes at User's own expenses while keep Licensor and Original Right Holder harmless.

Article 7 (Secrecy Obligation)

User shall keep confidential Licensed Software provided hereunder, information contained in the associated literature or the like and those provisions of this agreement not yet in public knowledge and may not disclose or leak these to third parties without prior written consent from Licensor.

Article 8 (Cancellation of the Agreement)

Licensor reserves the right to cancel this agreement forthwith and claim compensation from User for the damages caused by such cancellation when User:

- (1) Breaches any of the provisions of this agreement, or
- (2) Has received a petition for seizure, provisional seizure, provisional disposition or any other kind of compulsory execution.

Article 9 (Destruction of Licensed Software)

If this agreement is terminated under the provision of the foregoing paragraph, User shall destroy Licensed Software, along with all associated literature and its duplicates, within two (2) weeks from the date of termination.

Article 10 (Copyright Protection)

1. Copyrights and all other intellectual property rights relating to Licensed Software shall reside with Licensor and Original Right Holder and in no circumstances with User.
2. User shall abide by the laws relating to copyrights and intellectual property rights in using Licensed Software.

Article 11 (Export Control)

1. Licensed Software and the associated literature or the like may not be exported to places outside the Country (including transmission outside the Country over the Internet or the like).
2. User agrees that Licensed Software is subject to export controls imposed by the Country and the United States of America.
3. User agrees to comply with all the international and domestic laws that apply to this software (U.S. Export Administration Regulations and regulations established by the U.S., the Country and their governmental agencies regarding usage by end users and export destinations).

Article 12 (Miscellaneous)

1. Even if this agreement is invalidated in part by law, all other provisions shall remain in effect.
2. Licensor and User shall consult each other in good faith to resolve any matters not provided for in this agreement or questions arising from the interpretation of this agreement.
3. Licensor and User agree that this agreement is governed by the law of Japan and that all disputes involving claims and obligations that may arise out of this agreement will be settled by arbitration at the Tokyo District Court as the court of first instance.

Contents

Before Use 6

Precautions.....	6
How to read this manual	6

Basic Operations 7

Functions of the Buttons on the Front Panel ...	7
Turning on the Unit	8
Initial Settings.....	8
Adjusting the volume	10
Touch screen operations	10
Display the HOME screen	11
Popup menu	11
Source selection screen description.....	12
Source control screen descriptions	14
List screen	15

Widget 16

Widget.....	16
Multi Widget.....	16
Weather Widget.....	18
Photo Frame Widget	18
Importing Image Files.....	19
Widget SETUP	19

APPS 20

Wireless Mirroring Operation.....	20
Apple CarPlay Operation	20
Android Auto Operation.....	22
KENWOOD Traffic Powered By INRIX.....	24

USB 25

Connecting a USB device	25
USB Basic Operation.....	25
Search Operation.....	27

iPod/iPhone 28

Preparation	28
iPod/iPhone Basic Operation	29
Search Operation.....	30

Radio 31

Radio Basic Operation	31
Memory Operation	32
Selecting Operation	33
Traffic Information	33

HD Radio™ Tuner 34

HD Radio Tuner Basic Operation.....	34
Receive Mode	36
Memory Operation	36
Selecting Operation	36
Bookmark.....	38
Alert Message	39

SiriusXM® 40

SiriusXM® Basic Operation40
Storing Channels in Preset Memory.....42
Preset select42
Direct search42
Category/Channel search.....43
Replay43
TuneMix™44
SmartFavorites, TuneStart™44
TuneScan™44
Traffic & Weather Now™45
Content Alerts.....45
SportsFlash™46
SiriusXM SETUP46

Bluetooth Control 52

Information for using Bluetooth® devices.....52
Register the Bluetooth device53
Playing the Bluetooth Audio Device56
Using the Hands-Free Unit.....58
Hands-Free Setup.....63

Other External Components 64

View Camera64
Use Dashboard Camera.....66
External audio/video players67
HDMI source.....67
Maestro Features Operation.....67

Setup 69

Monitor Screen Setup69
System Setup69
User Interface Setup.....70
Special Setup71
Display Setup.....71
AV Setup73
Connection Setup73

Controlling Audio 75

3-way speaker system setup75
Speaker / X'over setup76
Controlling General Audio78
Equalizer Control78
Volume Offset.....79
Sound Effect80
Listening Position / DTA81
Audio Setup memory82

Remote control 83

Battery Installation.....83
Functions of the Remote control Buttons83

Connection/Installation 86

Before Installation86
Installing the unit88

Troubleshooting 95

Problems and Solutions95
Error Messages95

Appendix 97

Playable Media and Files.....97
Specifications.....98
About this Unit 101

Before Use

Precautions

⚠ WARNINGS

📖 To prevent injury or fire, take the following precautions:

- To prevent a short circuit, never put or leave any metallic objects (such as coins or metallic tools) inside the unit.
- Do not watch or fix your eyes on the unit's display when you are driving for any extended period.
- If you experience problems during installation, consult your KENWOOD dealer.

📖 Precautions on using this unit

- When you purchase optional accessories, check with your KENWOOD dealer to make sure that they work with your model and in your area.
- You can select a language to display menus, audio file tags, etc. See **User Interface Setup (P.70)**.
- The Radio Broadcast Data System feature won't work in areas where the service is not supported by any broadcasting station.

📖 Protecting the monitor

- To protect the monitor from damage, do not operate the monitor using a ball point pen or similar tool with a sharp tip.

📖 Cleaning the unit

- If the faceplate of this unit is stained, wipe it with a dry soft cloth such as a silicon cloth. If the faceplate is stained badly, wipe it with a cloth moistened with neutral cleaner, then wipe it again with a clean soft dry cloth.

NOTE

- Applying spray cleaner directly to the unit may damage its mechanical parts. Wiping the faceplate with a hard cloth or using a volatile liquid such as thinner or alcohol may scratch the surface or erase the screened print.

📖 Acquiring GPS signal

The first time you turn on this unit, you must wait while the system acquires satellite signals for the first time. This process could take up to several minutes. Make sure your vehicle is outdoors in an open area away from tall buildings and trees for fastest acquisition.

After the system acquires satellites for the first time, it will acquire satellites quickly each time thereafter.

📖 About GLONASS

This unit uses Global Navigation Satellite System (GLONASS) in addition to GPS.

Combining GPS and GLONASS can refine positioning accuracy than using GPS only.

📖 Caution for Smartphone Users

Simultaneously running multiple applications on your smartphone while screen sharing places heavy demand on the microprocessor of the phone, potentially affecting communication and performance.

For best results while pairing with your KENWOOD receiver, please be sure to close any unused applications.

How to read this manual

- The screens and panels shown in this manual are examples used to provide a clear explanation of operations. For this reason, they may be different from the actual screens or panels, or some display patterns may be different from the actual ones.
- **Display language:** English is used for the purpose of explanation. You can select a display language from the **SETUP** menu. See **User Interface Setup (P.70)**.



This symbol on the product means there are important operating and maintenance instructions in this manual.

Be sure to carefully read instructions in this manual.

Basic Operations

Functions of the Buttons on the Front Panel

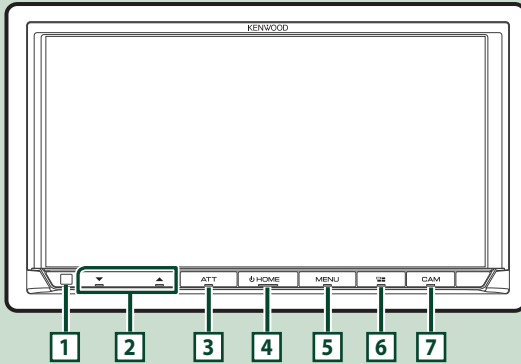

NOTE

- The panels shown in this manual are examples used to provide a clear explanation of operations. For this reason, they may be different from the actual panels.

Number	Name	Motion
1	Remote Sensor	<ul style="list-style-type: none"> Receives the remote control signal.
2	▼, ▲ (Volume)	<ul style="list-style-type: none"> Adjusts the volume. The volume will go up to 15 when you keep pressing ▲. (P.10)
3	ATT	<ul style="list-style-type: none"> Switches attenuation of the volume on/off.
4	HOME	<ul style="list-style-type: none"> Displays the HOME screen (P.11). Pressing for 1 second turns the power off. When the power is off, turns the power on.
5	MENU	<ul style="list-style-type: none"> Displays the popup menu screen. Pressing for 1 second turns the screen off.
6		<ul style="list-style-type: none"> Displays the APP (Apple CarPlay/Android Auto/Wireless Mirroring) screen. Pressing and holding displays the Voice Recognition screen (P.60). When neither Apple CarPlay, Android Auto, nor a Bluetooth Hands-Free phone is connected, pressing and holding displays Bluetooth pairing waiting dialog. (P.53)
7	CAM	<ul style="list-style-type: none"> Switches view camera display on/off (P.64). The camera whose view is displayed first changes according to the "Camera Setup" setting and the shift lever position in the shift gate. The camera whose view was displayed last is kept and the same camera view will be displayed the next time. If its assignment setting is changed, the rear camera view is displayed.

Turning on the Unit

- 1 Press the **HOME** button.



➤ The unit is turned on.

● To turn off the unit

- 1 Press the **HOME** button for 1 second.

NOTE

- If it is your first time to turn the unit on after installation, it will be necessary to perform Initial SETUP (P.8).

Initial Settings

Initial SETUP

Perform this setup when you use this unit first time.

- 1 Set each item as follows.

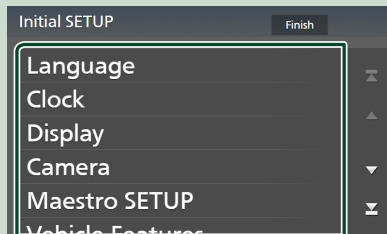

■ Language

Select the language used for the control screen and setting items. Default is "American English(en)".

- ① Touch **Language**.
- ② Touch **Language Select**.
- ③ Select the desired language.
- ④ Touch .

For details, see **User Interface Setup (P.70)**.

■ Clock



Sets the synchronization of the clock and adjusts it.

For details, see **Date and clock settings (P.9)**.

■ Display

Set the key illumination color.

If it is hard to see the image on the screen even, adjust the viewing angle.

- ① Touch **Display**.
- ② Touch **Key Color**.
- ③ Select the desired color.
- ④ Touch .
- ⑤ Touch **Viewing Angle**.
- ⑥ Select a viewing angle.
- ⑦ Touch .

For details, see **Display Setup (P.71)**.

■ Camera

Set the parameters for the camera.

- ① Touch **Camera**.
- ② Set each item and touch .

For details, see **Camera Setup (P.64)**.

■ Maestro SETUP

This function requires a commercial adaptor. Consult your KENWOOD dealer for details.

■ Vehicle Features

This function requires a commercial adaptor. Consult your KENWOOD dealer for details.

■ DEMO

Set the demonstration mode. Default is "ON".

2 Touch Finish.

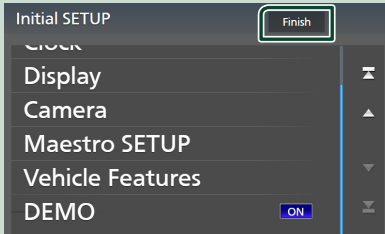

NOTE

- These settings can be made from the SETUP menu. See **Setup (P.69)**.

Date and clock settings

1 Press the **MENU** button.

- Popup menu appears.

2 Touch **SETUP**.



- SETUP Menu screen appears.

3 Touch **User Interface**.

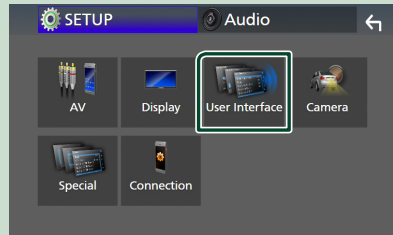

- User Interface screen appears.

4 Set each item as follows.

Scroll the page to show hidden items.

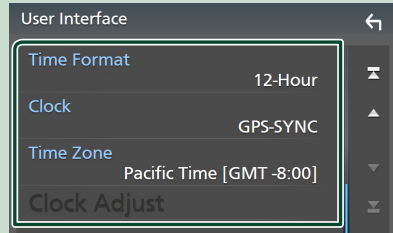

■ Time Format

Select the time display format.

12-Hour (Default)/ **24-Hour**

■ Clock

GPS-SYNC (Default): Synchronizes the clock time with the GPS.

Manual: Set the clock manually.

■ Time Zone

Select the time zone.

■ Clock Adjust

If you select **Manual** for Clock, adjust the date and time manually. **(P.10)**

NOTE

- Please set the date and time. If they are not set, some functions may not work.

Adjust the date and time manually

- 1** Touch **Clock** on the User Interface screen.
- 2** Select **Manual**.
- 3** Touch **Time Zone** on the User Interface screen.
- 4** Select the time zone.
- 5** Touch **Clock Adjust** on the User Interface screen.
- 6** Adjust the date, then adjust the time.

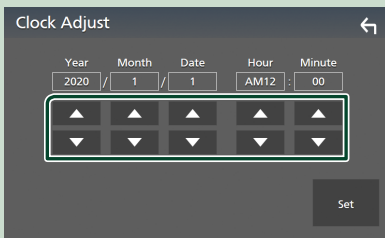

- 7** Touch **Set**.

Adjusting the volume

You can adjust the volume (0 to 40).
Press ▲ to increase, and press ▼ to decrease.
Holding ▲ increases the volume continuously to level 15.



Touch screen operations

To perform operations on the screen, you need to touch, touch and hold, flick or swipe to select an item, display a setting menu screen or change pages.

● **Touch**

Touch the screen gently to select an item on the screen.

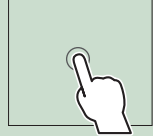

● **Touch and hold**

Touch the screen and keep your finger in place until the display changes or a message is displayed.

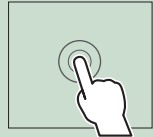

● **Flick**

Slide your finger quickly to the left or right on the screen to change the page. You can scroll a list screen by flicking up/down on the screen.

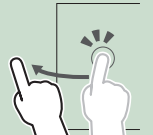

● **Swipe**

Slide your finger up or down on the screen to scroll the screen.



Display the HOME screen

- 1 Press the **HOME** button.



➤ HOME screen appears.

HOME screen descriptions

Most functions can be performed from the HOME screen.

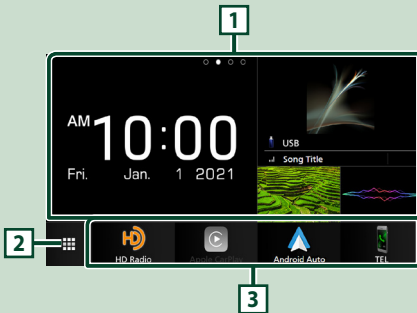







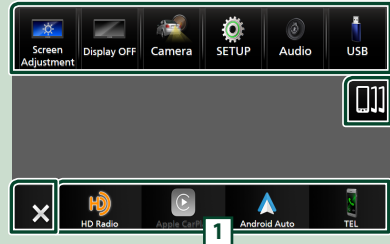

- 1 • Widget **(P.16)**
 - You can change the widget by flicking left or right on the widget area.
 - Touch the widget to display the detailed screen.
- 2 • Displays the source selection screen. **(P.12)**
- 3 • Short-cut playback source icons **(P.13)**

Popup menu

- 1 Press the **MENU** button.
 - Popup menu appears.
- 2 Touch to display the popup menu.



The contents of the menu are as follows.

	• Displays the Screen Adjustment screen. (P.69)
	• Turns the display off. (P.12)
	• Displays the view camera screen. (P.64)
	• Displays the SETUP Menu screen. (P.69)
	• Displays the Audio screen. (P.75)
	• Displays the control screen of current source. Icon feature differs depending on the source. This icon is for USB source.
	• Close the popup menu.
	• Displays the Device List screen. (P.53)
	1 • Short-cut source icons: The source changes to the one you have set with a short-cut. For the short-cut setting, refer to Customize Short-cut source icons on HOME screen (P.13) .

Turn off the screen

- 1 Select **Display OFF** on the popup menu.

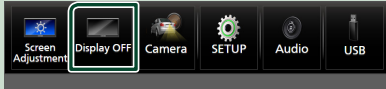

NOTE

- Touch the display to turn on the screen.
- To display the clock while the screen is off, it is necessary to set "OSD Clock" to "ON". **(P.71)**

Source selection screen description

You can display icons of all playback sources and options on the source selection screen.

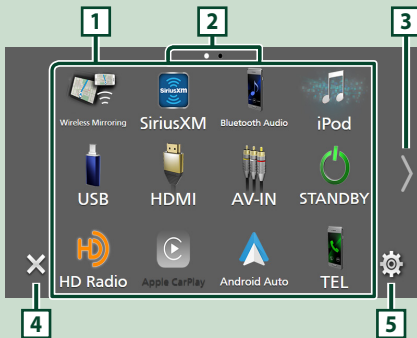

- 1 • Changes playback sources. For playback sources, see **Select the playback source (P.12)**.
- 2 • Page indication
- 3 • Changes pages. (Touch / .) You can also change pages by flicking left or right on the screen.
- 4 • Returns to the previous screen.
- 5 • Displays the SETUP Menu screen. **(P.69)**

Select the playback source

- 1 Press the **HOME** button.
➤ HOME screen appears.

- 2 Touch .

From the screen, you can select the following sources and functions.

	• Switches to the Apple CarPlay screen from the connected iPhone. (P.20)
	• Switches to the Android Auto screen from the connected Android™ smartphone. (P.22)
	• Displays the Hands-Free screen. (P.58) When neither Apple CarPlay, Android Auto, nor a Bluetooth Hands-Free phone is connected, displays Bluetooth pairing waiting dialog.*1 (P.53)
	• Switches to the Radio broadcast.*2 (P.31)
	• Switches to the HD Radio broadcast.*3 (P.34)
	• Switches to the SiriusXM® satellite radio broadcast. (P.40)
	• Plays a Bluetooth audio device. (P.56)
	• Plays an iPod/iPhone. (P.28)
	• Plays files on a USB device. (P.25)
	• Plays a device connected to the HDMI input terminal. (P.67)
	• Switches to an external component connected to the AV Audio input and the VIDEO input terminal. *4 *5 (P.67)
	• Switches to the Wireless Mirroring screen from the connected Android™ smartphone. (P.20)
	• Puts the unit in standby. (P.13)

• For sources and information displayed when an iDataLink is connected, see **Maestro Features Operation (P.67)**.

*1 When connecting as Apple CarPlay or Android Auto, it works as a phone provided in Apple CarPlay or Android Auto. If Apple CarPlay or Android Auto are connected during talking by the Bluetooth device or iDataLink phone, the current call will be continued.

*2 DMX9708S only

*3 DMX958XR / DMX908S only

*4 You can use the **AV-IN** source when a cable from a visual source except a camera is connected to the VIDEO input terminal, and a cable is connected to the AV Audio input terminal. **(P.92)**

*5 This can be selected when the AV-IN is set to **NONE** on the Camera Assignment Setting screen. **(P.65)**

To select the playback source on the HOME screen



The 4 items displayed in the bottom row on the source selection screen are shown on the HOME screen.

You can change the items displayed on this area by customizing the source selection screen. **(P.13)**

To select the playback source on the source control screen

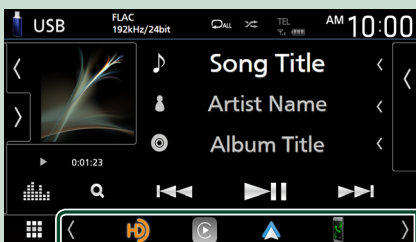

Display source selection icons by touching **[</>]** or flicking left or right on the source control screen, then select a playback source.

Put the unit in standby

1 Press the **HOME** button.
➤ HOME screen appears.

2 Touch **[Grid Icon]**.

3 Touch **STANDBY**.



Customize Short-cut source icons on HOME screen

You can arrange the positions of the source icons as you like.

1 Press the **HOME** button.
➤ HOME screen appears.

2 Touch **[Grid Icon]**.

3 Touch and hold the icon which you want to move in the customizing mode.

4 Drag the icon to the desired position.



Changes the page

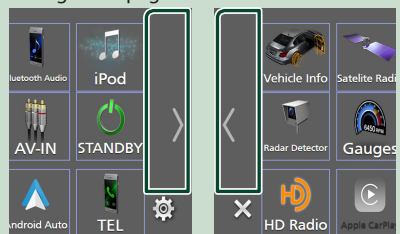

Source control screen descriptions

There are some functions which can be performed from most screens.

Indicators

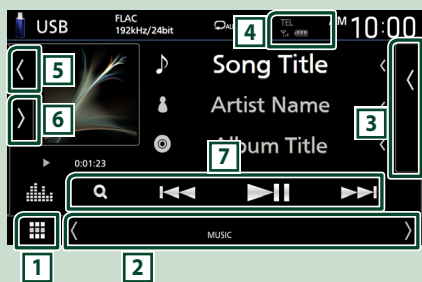

Short-cut source icons



1 All sources icon

Displays the source selection screen. (P.12)

2 Secondary screen

- : The Secondary screen changes to another one every time you touch it. You can also change the Secondary screen by flicking left or right on the screen.
- Indicators: Displays the current source condition and so on.
 - **ATT**: The attenuator is active.
 - **MUTE**: The mute function is active.
 - **LOUD**: The loudness control function is active.
- Short-cut source icons: The source changes to the one you have set with a short-cut. For the short-cut setting, refer to **Customize Short-cut source icons on HOME screen (P.13)**.

3 Content list

Displays the track/file/station/channel list.



- Connected Bluetooth device information.

5 Artwork & information

You can select whether to display an artwork and song information or only song information in more detail.

Touching the artwork area switches to the VU meter. (The USB, iPod, Bluetooth audio sources only)

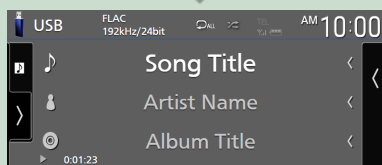
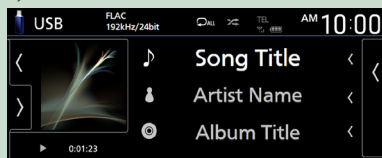

Change the text size of song information when the "Small Audio Text" is set to "ON"/"OFF" in the User Interface screen (P.70).

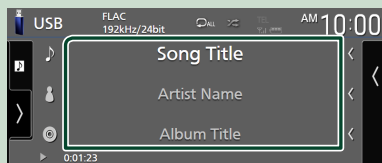
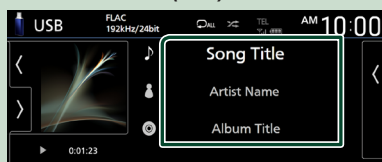

6 Function panel

Touch the left side of the screen to display the function panel. Touch again to close the panel.

7 Operation keys

You can operate the current source with these operation keys. The available functions are different depending on the source type.

List screen

There are some common function keys in the list screens of most sources.
The operation and the display screen are different for each source. (P.27, 30, 57)

Display the list screen

For USB/iPod:

- 1 Touch **Q** or the item listed on the information area in the source control screen.

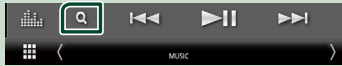

► The list screen appears.

For Bluetooth audio:

- 1 Touch **Q**.



► The list screen appears.

You can use following operation keys from this screen.

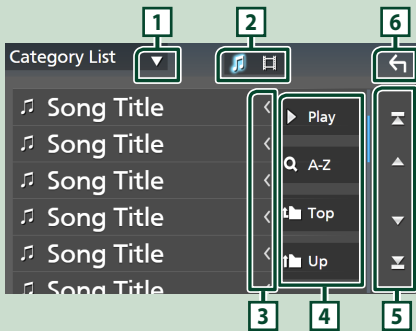

- 1 Displays the list type selection window.

- 2 Displays a music/movie file list.

- 3 **Text scroll**
Scrolls the displayed text.

- 4 **Play** etc.

Keys with various functions are displayed here.

- **Play**: Plays all tracks in the folder containing the current track.
- **A-Z**: Jumps to the letter you entered (alphabetical search).
- **Top Up**: Moves to the upper hierarchy level.

- 5 / **Page scroll**

You can change pages to display more items by touching / .

- / : Displays the top or bottom page.

- 6 **Return**

Returns to the previous screen.

NOTE

- Depending on the current source or mode, some function key may not appear.

Widget

Widget

- 1 Press the **HOME** button.
- 2 You can change the widget by flicking left or right on the widget area.



Widget list

- Weather Widget *1
- Multi Widget *2
- Clock Widget
- Tire Pressure Widget *3
- Radar Widget *3
- Climate Widget *3
- Photo Frame Widget

*1 You can receive INRIX weather forecast by connecting your iPhone or Android smartphone in which the "KENWOOD Traffic Powered By INRIX" application is installed.
 *2 Up to 3 pages can be set to the multi widget screen.
 *3 Displayable widgets vary depending on the type of the connected iDataLink (commercially available) and the model of the vehicle.

Multi Widget

You can place a widget on each of the following areas. Up to 4 widgets can be placed per a multi widget screen.

- 1 Press the **HOME** button.
- 2 Flick the widget area to the left/right to display the multi widget.

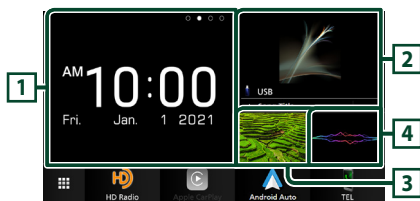

1 Widget (L)

2 Widget (M)

3 Widget (S1)

4 Widget (S2)

Replace the widget

● To move the widget

- 1 Touch and hold the widget.
 - Widget customize mode is activated.
- 2 Drag the widget to the desired position.

● To delete the widget

- 1 Touch and hold the widget.
 - Widget customize mode is activated.
- 2 Touch **×** on the right top corner of the widget.
 - The selected widget is deleted.

● To replace the widget

1 Touch on the multi widget screen.

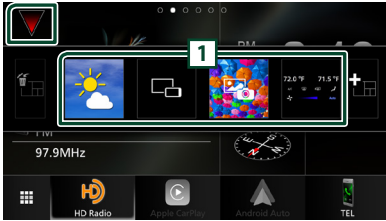

➤ Widget list popup appears.

1 Widget icon

The widgets which can be placed to the multi widget screen are listed.

2 Flick the widget list popup to the left/right to select the widget to replace.

3 Touch and hold the new widget.

➤ Widget customize mode is activated.

4 Drag the widget from the widget list popup to the desired widget area.

You can set up following items.

- Clock Widget
- Weather Widget *1
- Compass Widget
- Current source information *2
- Visualizer Widget
- Mirroring Widget *3 *4
- Photo Frame Widget
- Climate Widget *5
- Radar Widget *5
- Tire Pressure Widget *5

*1 You can receive INRIX weather forecast by connecting your iPhone or Android smartphone in which the "KENWOOD Traffic Powered By INRIX" application is installed.



*2 You cannot display the screen of Wireless Mirroring on this widget. To display the screen of the source, select the Mirroring Widget.

*3 This can be selected when using Wireless Mirroring.

*4 You cannot play the video file on the USB device when using Wireless Mirroring.

*5 This can be selected when the iDatalink (commercially available) is connected.

NOTE

-  and the widget list popup disappear when no operation is done for 5 seconds.
- When the screen is switched from another widget to multi widget screen,  appears again.

Add a new multi widget

You can add pages to the multi widget screen.

1 Touch on the multi widget screen.

➤ Widget list popup appears.

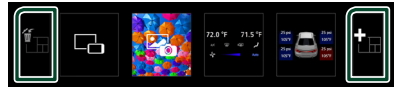

Displays confirmation message to delete the current page from the multi widget screen. For details, see **To delete the multi widget (P.17)**.



Adds a page to the multi widget screen.

2 Touch on the widget list popup.

➤ A new page is added.

NOTE

- You can add up to 2 pages to the multi widget screen. If you have already added 2 pages, you cannot select .
- The widget list popup is displayed on the new page until you place a widget to.

To delete the multi widget

1 Touch on the widget list popup.

➤ Confirmation message appears.

2 Touch **Yes**.

➤ Current page is deleted.

NOTE

- You cannot delete the first page of the multi widget screen.

Weather Widget

You can display the weather forecast of the present location on the Home screen.

Preparation

- See **KENWOOD Traffic Powered By INRIX (P.24)**.
- Select "ON" for Weather Widget. See **Widget SETUP (P.19)**.

- 1 Press the **HOME** button.
- 2 Flick the widget area to the left/right to display the weather widget.

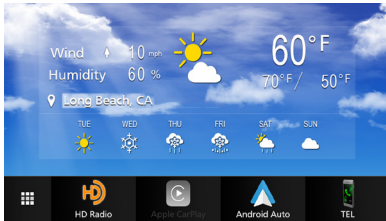

Photo Frame Widget

You can display a slideshow of the image files stored in your iPhone or Android smartphone on the Home screen.

Preparation

- See **Importing Image Files (P.19)**.
- Select "ON" for Photo Frame Widget. See **Widget SETUP (P.19)**.

Photo Frame

- 1 Press the **HOME** button.
- 2 Flick the widget area to the left/right to display the photo frame widget.

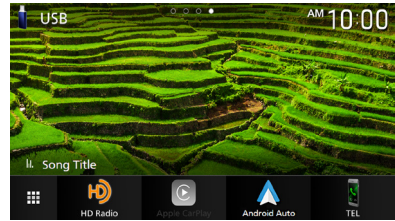

- To scroll the screen to display the hidden part, select "ON" for **Photo Frame Scroll**. See **Widget SETUP (P.19)**.

Importing Image Files

You can display image files stored in your iPhone or Android smartphone by connecting your iPhone or Android smartphone in which the "KENWOOD Portal APP" application is installed to this unit.

The image files are displayed on the photo frame widget. Also, you can set an image as the wallpaper.

See **Photo Frame Widget (P.18)** and **To register an original image (P.72)**.

Preparation

- Install the latest version of the "KENWOOD Portal APP" application on your iPhone or Android smartphone.
 - iPhone: Search for "KENWOOD Portal APP" in the Apple App Store to find and install the most current version.
 - Android smartphone: Search for "KENWOOD Portal APP" on Google Play to find and install the most current version.
- For details, see "KENWOOD Portal APP" application.

1 Connect the device.

- To connect a device via Bluetooth, register it as the Bluetooth device and do the App (SPP) profile setting of the connection beforehand. See **Register the Bluetooth device (P.53)** and **Switch the connected device (P.54)**.
- Connect an iPhone via the USB terminal. (P.93)

2 Unlock your device.

Widget SETUP

Set up the widgets on the Home screen.

1 Press the **MENU** button.

- Pop-up menu appears.

2 Touch **SETUP**.

- SETUP screen appears.

3 Touch **User Interface**.

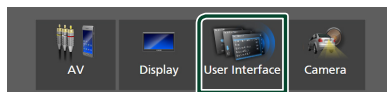

- User Interface screen appears.

4 Touch **Widget SETUP** in the **User Interface** screen.

5 Set each item as follows.

■ **Weather Widget**

Determine whether to use the weather widget.

"ON" (Default)/"OFF"

■ **Photo Frame Widget**

Determine whether to use the photo frame widget.

"ON" (Default)/"OFF"

■ **Photo Frame Scroll**

Select whether to use the scroll function on the photo frame widget.

ON (Default): You can see the image scrolled up/down/left/right when the image is larger than the screen.

OFF: The screen displays only in center of the image when the image is larger than the screen.

6 Touch .

APPS

Wireless Mirroring Operation

You can display the same screen of the Android smartphone on the monitor of the unit using the Wireless Mirroring function of the Android smartphone.

Preparation

- You can use the Wireless Mirroring function with Android smartphones compatible with this function.
- This function may be called Wireless Display, Screen Mirroring, AllShare Cast, etc., depending on the manufacturer.
- The settings on the Android smartphone differ depending on the device type. For details, refer to the instruction manual supplied with your Android smartphone.
- If your Android smartphone is locked, Mirroring screen may not appear.
- If the Android smartphone is not ready for UIBC, you cannot perform touch operation.

- 1 Press the **HOME** button.
- 2 Touch .
- 3 Touch **Wireless Mirroring** . (P.12)
 - The App screen is displayed.
- 4 Operate your Android smartphone to activate the **Wireless Mirroring** function, then connect to this unit.
- 5 Select ("DMX****") as the network to use.
 - When the connection is established, then the same screen displayed on the Android smartphone is displayed.

NOTE

- Apps is discontinued when the power is turned ON/OFF or you leave the vehicle. To restart Apps, operate the Android smartphone.
- When the Apps source is displayed, you cannot register or reconnect a Bluetooth device. Switch the Apps source to another source, and then operate the Bluetooth device.
- The device name selected on step 5 can be changed. See **Change the device name for Wireless Mirroring** (P.74).

Apple CarPlay Operation

Apple CarPlay is a smarter, safer way to use your iPhone in the car. Apple CarPlay takes the things you want to do with iPhone while driving and displays them on the screen of the product. You can get directions, make calls, send and receive messages, and listen to the music from iPhone while driving. You can also use Siri voice control to make it easier to operate iPhone.

For details about Apple CarPlay, visit <https://www.apple.com/ios/carplay/>.

Compatible iPhone devices

You can use Apple CarPlay with the following iPhone models.

- | | |
|------------------------------|------------------|
| • iPhone 12 Pro Max | • iPhone XS |
| • iPhone 12 Pro | • iPhone XR |
| • iPhone 12 | • iPhone X |
| • iPhone 12 mini | • iPhone 8 Plus |
| • iPhone SE (2nd generation) | • iPhone 8 |
| • iPhone 11 Pro Max | • iPhone 7 Plus |
| • iPhone 11 Pro | • iPhone 7 |
| • iPhone 11 | • iPhone SE |
| • iPhone XS Max | • iPhone 6s Plus |
| | • iPhone 6s |

Connecting an iPhone

Wired connection

- 1 Connect your iPhone via the USB terminal by the following methods. (P.93)
 - Connect using KCA-iP103 (optional accessory) and USB adaptor.
 - Connect using USB-C to Lightning cable (sold separately).

When an iPhone compatible with Apple CarPlay is connected to the USB terminal, the Bluetooth Hands-Free phone currently connected is disconnected. If another Bluetooth Hands-Free phone is being used, disconnection will occur after ending the call.

- 2 Unlock your iPhone.

Wireless connection

You can select the iPhone registered in **Device List** and use it as the Apple CarPlay device.

See **Register the Bluetooth device (P.53)**.

- 1 Press the **HOME** button.
- 2 Touch .
- 3 Touch **Apple CarPlay**. (P.12)

NOTE

- Turn on the Bluetooth function and Wi-Fi function of an iPhone.
- If two or more iPhone have been registered, select the iPhone to be used as the **Apple CarPlay** source. (P.21)
- It is necessary to connect the GPS antenna in order to use a wireless Apple CarPlay.
- When the Wi-Fi connection becomes unavailable, the HOME screen is displayed.
- You cannot use Apple CarPlay if the function is turned off by operating the iPhone at functional setup.

To switch the Current Screen to the Apple CarPlay Screen When Connecting Your iPhone

- Touch **Apple CarPlay** icon on the source selection screen. (P.12)
- Touch the following connection message if the message appears.

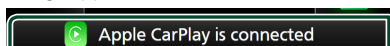

NOTE

- The connection message appears when;
 - The iPhone you used previously is connected again.
 - The screen other than HOME and the source selection screen is displayed.
- The connection message is displayed for about 5 seconds.
- If the system fails to get a friendly name from the connected iPhone, the subject of the connection message will be "Apple CarPlay" or "**** device".

Select an Apple CarPlay device

If two or more iPhone compatible with Apple CarPlay have been registered, select the iPhone to be used as the Apple CarPlay source.

See **Switch the connected device (P.54)**.

Operation keys and available Apps on the home screen of Apple CarPlay

You can use the Apps of the connected iPhone.

The items displayed and the language used on the screen differ among the connected devices.

To enter the Apple CarPlay mode, touch **Apple CarPlay** icon on the source selection screen. (P.12)

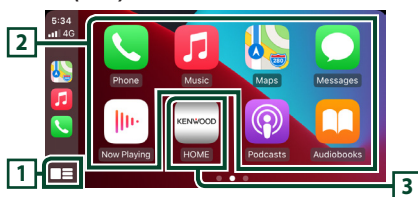

- 1 

- Displays the home screen of Apple CarPlay.
- Touch and hold to activate Siri.

2 Application keys

Starts the application.

3 HOME

Exits the Apple CarPlay screen and displays the Home screen.

* The icon design may change depending on the iOS version.

To exit the Apple CarPlay screen

- 1 Press the **HOME** button.

Use Siri

You can activate Siri.

- 1 Press the  button for 1 second.

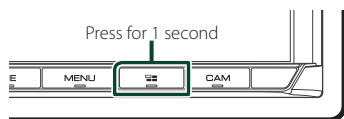

- 2 Talk to Siri.

To deactivate

- 1 Press the  button.

Switch to the Apple CarPlay screen while listening to another source

- 1 Press the  button.



NOTE

- When listening to another source with the Apple CarPlay screen displayed, playing music in the Apple CarPlay mode will switch the current source to the Apple CarPlay source.

Android Auto™ Operation

Android Auto enables you to use the functions of your Android smartphone convenient for driving. You can easily access route guidance, make calls, listen to music, and access convenient functions on the Android smartphone while driving.

For details about Android Auto, visit <https://www.android.com/auto/> and <https://support.google.com/androidauto>.

Compatible Android devices

You can use Android Auto with Android devices of Android version 6 or later.

For Wi-Fi connection, Android 8 or later.

NOTE

- Android Auto may not be available on all devices and may not be available in all countries or regions.

● About the placement of smartphone

Install the smartphone connected as Android Auto device in the place where it can receive the GPS signals.

When using Google Assistant, install the smartphone in the place where the smartphone easily catch a voice by the microphone.

NOTE

- Do not put the smartphone in a spot exposed to direct sunlight or near an air blowing out port of an air conditioner. The placement of the smartphone in such places can lead to malfunction or damage of your smartphone.
- Do not leave the smartphone in the vehicle.

Connect Android smartphone

Wired connection

1 Connect an Android smartphone via the USB terminal. (P.94)

To use the Hands-Free function, connect the Android smartphone via Bluetooth.

When an Android smartphone compatible with Android Auto is connected to the USB terminal, the device is connected via Bluetooth automatically, and the Bluetooth Hands-Free phone currently connected is disconnected.

2 Unlock your Android smartphone.

3 Press the **HOME** button.

4 Touch .

5 Touch **Android Auto**. (P.12)

Wireless connection

You can select the Android smartphone registered in **Device List** and use it as the Android Auto device. See **Register the Bluetooth device** (P.53).

1 Press the **HOME** button.

2 Touch .

3 Touch **Android Auto**. (P.12)

NOTE

- Turn on the Bluetooth function and Wi-Fi function of Android smartphone.
- If two or more Android smartphones have been registered, select the Android smartphone to be used as the Android Auto source. (P.23)
- To change the password for wireless connection manually, refer to **Reset Android Auto Wireless Connection** (P.74).
- When the Wi-Fi connection becomes unavailable, the HOME screen is displayed.

Select an Android smartphone

If two or more Android smartphones have been registered, select the Android smartphone to be used as the Android Auto source.

See **Switch the connected device** (P.54).

Operation keys and available Apps on the Android Auto screen

You can perform the operations of the Apps of the connected Android smartphone.

The items displayed on the screen differ among the connected Android devices.

To enter the Android Auto mode, touch the **Android Auto** icon on the source selection screen. (P.12)

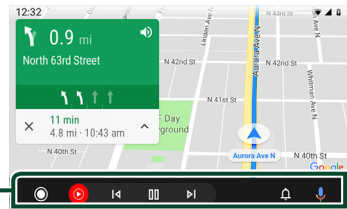

1

1 Application/information keys

Starts the application or displays information.

To exit the Android Auto screen

1 Press the **HOME** button.

Using voice control

1 Press the button for 1 second.

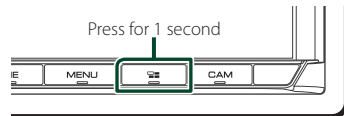

2 Start speaking.

NOTE

- When you press and hold the  button while inputting voice, you can start over from the beginning.

To cancel

1 Press the  button.

 **Switch to the Android Auto screen while listening to another source**

1 Press the  button.

**NOTE**

- When listening to another source with the Android Auto screen displayed, playing music in the Android Auto mode will switch the current source to the Android Auto source.

KENWOOD Traffic Powered By INRIX

You can receive INRIX weather forecast by connecting your iPhone or Android smartphone in which the "KENWOOD Traffic Powered By INRIX" application is installed to this unit.

Preparation

- Install the latest version of the KENWOOD Traffic Powered By INRIX application on your iPhone or Android smartphone.
 - iPhone: Search for "KENWOOD Traffic Powered By INRIX" in the Apple App Store to find and install the most current version.
 - Android smartphone: Search for "KENWOOD Traffic Powered By INRIX" on Google Play to find and install the most current version.
- For details, see "KENWOOD Traffic Powered By INRIX" application.
- The specifications may be changed as the INRIX weather forecast is provided by a third party. Therefore, the service may not be available.

1 **Connect the device.**

- To connect a device via Bluetooth, register it as the Bluetooth device and do the App (SPP) profile setting of the connection beforehand. See **Register the Bluetooth device (P.53)** and **Switch the connected device (P.54)**.
- Connect an iPhone via the USB terminal. (P.93)

NOTE

- When an Apple CarPlay is connected, you can receive INRIX weather forecast.

2 **Unlock your device.**

USB

Connecting a USB device

- 1 Connect the USB device via the USB terminal. (P.93)

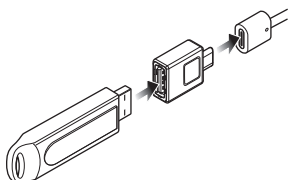

- 2 Press the **HOME** button.
- 3 Touch .
- 4 Touch **USB**. (P.12)

Disconnect the USB device

- 1 Press the **HOME** button.
- 2 Touch a source other than **USB**.
- 3 Detach the USB device.

Usable USB device

You can use a mass-storage-class USB device with this unit.

The word "USB device" appearing in this manual indicates a flash memory device.

● About the file system

The file system should be the one of the following.

- FAT16
- FAT32
- exFAT
- NTFS

NOTE

- Install the USB device in the place where it will not affect safe driving.
- You cannot connect a USB device via a USB hub and Multi Card Reader.
- Take backups of the audio files used with this unit. The files can be erased depending on the operating conditions of the USB device. We shall have no compensation for any damage arising from any erased data.

USB Basic Operation

Most functions can be controlled from the source control screen and playback screen.

NOTE

- Set the remote controller mode switch to **AUD** mode before starting operation, see **Switch the operation mode (P.83)**.

Control screen

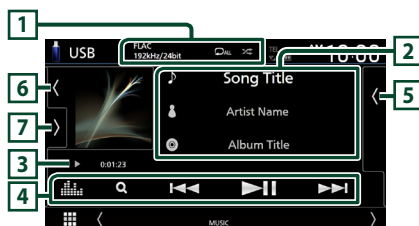





Open the drawer

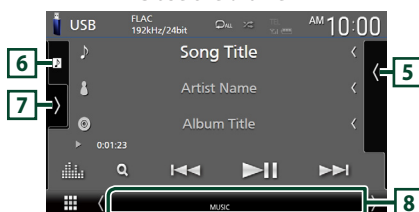



Close the drawer



1 CODEC/Repeat/Random







- When a high-resolution source is played, its format information is displayed.
- : Repeats the current track/folder. Each time you touch the key, repeat modes are switched in the following sequence: File repeat () , Folder repeat () , Repeat all ()

-  : Randomly plays all tracks in the current folder. Each time you touch the key, random modes are switched in the following sequence: File random (), Random off ()

2 Track information









- Displays the information on the current file. Only a file name and a folder name are displayed if there is no tag information.
- Change the text size of the information when the "Small Audio Text" is set to "ON"/"OFF" in the User Interface screen (P.70).

3 Play mode indicator/Playing time

- , , etc.: Current play mode indicator. Meanings of individual icons are as follows:  (play),  (fast forward),  (fast backward),  (pause).
- For confirmation of current playing position. You can drag the circle left or right to change the playing position. (Video file only)



4 Operation keys

-  : Searches track/file. For details on search operation, see **Search Operation (P.27)**.
-     : Searches the previous/next track/file. Touch and hold to fast forward or fast backward. (It will be cancelled automatically after about 50 seconds.)
-   : Plays or pauses.
-  : Displays the Graphic Equalizer screen. (P.78)

5 Content list



- Touch the right side of the screen to display the Content list. Touch again to close the list.
- Displays the playing list. When you touch a track/file name on the list, playback will start.

6 Artwork/VU meter

- Displays/hides artwork area.
- The jacket of the currently playing file is displayed.
- Touch to switch between the artwork and VU meter.

7 Function panel

Touch the left side of the screen to display the function panel. Touch again to close the panel.

-   : Searches for the previous/next folder.

8 Indicator Items

- **VIDEO**: Identifies the video file.
- **MUSIC**: Identifies the music file.

Video screen



9 File search area (Video file only)

Touch to search for the next/previous file.

10 Key display area (Video file only)

Touch to display the control screen.

Search Operation

You can search music or video files by the following operations.

- 1 Touch **Q**.
- 2 Touch **▼**.



- 3 Select a list type.

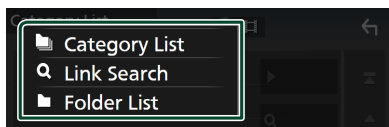

NOTE

- For operations on the list screen, see *List screen (P.15)*.

Category search

You can search for a file by selecting a category.

- 1 Touch **Category List**.
- 2 Select whether you search audio files or video files .
- 3 Touch the desired category.

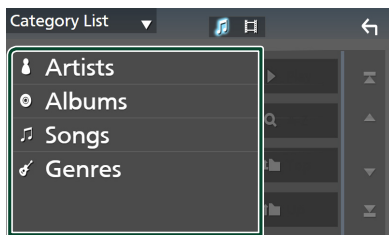

- The list corresponding to your selection appears.

- 4 Touch to select the desired item in the list. Repeat this step until you find the desired file.

Link search (Audio file only)

You can search for a file of the same artist/album/genre as that in the current track.

- 1 Touch **Link Search**.
- 2 Touch the desired tag type. You can select from artists, albums and genres.

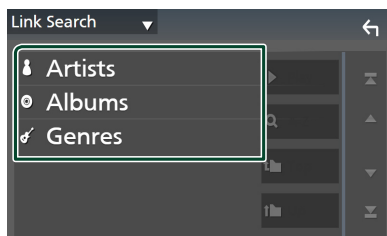

- The list corresponding to your selection appears.

- 3 Touch the desired item in the content list.

Folder search

You can search for a file according to hierarchy.

- 1 Touch **Folder List**.
- 2 Touch the desired folder.

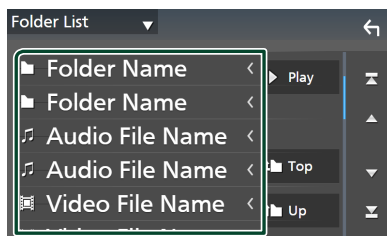

When you touch a folder its contents are displayed.

- 3 Touch to select your desired item in the list. Repeat this step until you find the desired file.

iPod/iPhone

Preparation

Connectable iPod/iPhone

The following models can be connected to this unit.

Made for

- iPhone 12 Pro Max
- iPhone 12 Pro
- iPhone 12
- iPhone 12 mini
- iPhone SE (2nd generation)
- iPhone 11 Pro Max
- iPhone 11 Pro
- iPhone 11
- iPhone XS Max
- iPhone XS
- iPhone XR
- iPhone X
- iPhone 8 Plus
- iPhone 8
- iPhone 7 Plus
- iPhone 7
- iPhone SE
- iPhone 6s Plus
- iPhone 6s
- iPod touch (7th generation)

NOTE

- Latest compatible list of iPod/iPhone. For details, see www.kenwood.com/cs/ce/ipod/.
- By connecting your iPod/iPhone to this unit, you can supply power to your iPod/iPhone as well as charge it while playing music. Note that the power of this unit must be held on.
- If you restart playback after connecting the iPod, the music that has been played by the iPod is played first.

Connect iPod/iPhone

Wired connection

Preparation

- Connect an iPod/iPhone while Apple CarPlay is not connected.
- With an iPhone compatible with Apple CarPlay, turn off Apple CarPlay by operating the iPhone at functional setup before connecting iPhone. For details of the setup method, contact the manufacturer of the terminal.
- Only one iPod/iPhone can be connected.

1 Connect your iPod/iPhone via the USB terminal by the following methods. (P.93)

- Connect using KCA-iP103 (optional accessory) and USB adaptor.
- Connect using USB-C to Lightning cable (sold separately).

2 Press the **HOME** button.

3 Touch .

4 Touch **iPod**. (P.12)

● To disconnect the iPod/iPhone connected with the cable

1 Detach the iPod/iPhone.

Bluetooth connection

Pair the iPhone through Bluetooth.

Preparation

- To connect an iPhone via Bluetooth, register it as a Bluetooth device and do the profile setting for the connection beforehand. See **Register the Bluetooth device (P.53)** and **Switch the connected device (P.54)**
- Connect an iPhone via Bluetooth while Apple CarPlay and an iPod/iPhone are not connected via USB.
- With an iPhone compatible with Apple CarPlay, turn off Apple CarPlay by operating the iPhone at functional setup before connecting iPhone. For details of the setup method, contact the manufacturer of the terminal.

● **Select the method of making connections for outputting sound from the iPod source**

- 1 Press the **MENU** button.
- 2 Touch **SETUP**.
 - SETUP Menu screen appears.
- 3 Touch **AV**.
 - AV screen appears.
- 4 Touch **iPod Bluetooth Connection**.
 - Bluetooth** (Default): Output sound using a Bluetooth device.
 - Bluetooth+HDMI**: Output sound using an HDMI device and perform music selection, etc. using a Bluetooth device.

iPod/iPhone Basic Operation

NOTE

- Set the remote controller mode switch to AUD mode before starting operation, see **Switch the operation mode (P.83)**.

Control screen

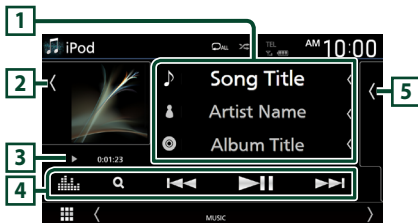

Open the drawer



Close the drawer

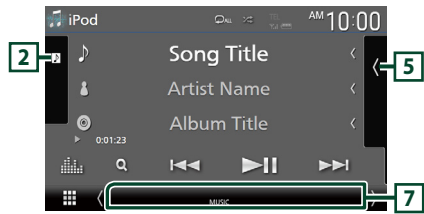

1 Track information

- Displays the information on the current file.
- Touch to display the category list screen. See **Category search (P.30)**.
- Change the text size of the information when the "Small AudioText" is set to "ON"/"OFF" in the User Interface screen (**P.70**).

2 Artwork/VU meter

- Displays/hides artwork area.
- The jacket of the currently being played file is displayed.
- Touch to switch between the artwork and VU meter.

3 Play mode indicator/Playing time

- ▶, ▶▶, etc.: Current play mode indicator
Meanings of individual icons are as follows:
▶ (play), ▶▶ (fast forward), ◀◀ (fast backward), || (pause).

4 Operation keys

- 🔍 : Searches for a track/file. For details on search operation, see **Search Operation (P.30)**.
- ◀◀ ▶▶ : Searches for the previous/next track/file.
Touch and hold to fast forward or fast backward. (It will be cancelled automatically after about 50 seconds.)
- ▶|| : Plays or pauses.
- 📊 : Displays the Graphic Equalizer screen. (**P.78**)

5 Content list

- Touch the right side of the screen to display the Content list. Touch again to close the list.
- Displays the playing list. When you touch a track/file name on the list, playback will start.

NOTE

- Content list cannot be used unless Category List is selected. To select a file, see **Category search (P.30)**.

6 Repeat/Random

- : Repeats the current track/album. Each time you touch the key, repeat modes are switched in the following sequence: Song repeat () , All songs repeat () , Repeat off ()
- : Randomly plays all tracks in the current album. Each time you touch the key, random modes are switched in the following sequence: Song random () , Random off ()

7 Indicator Items

- **MUSIC**: Identifies the music file.

Search Operation

You can search music files by the following operations.

- 1 Touch .
- 2 Touch .



- 3 Select a list type.

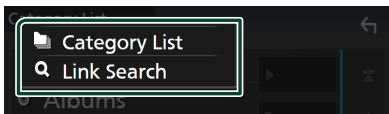

NOTE

- For operations on the list screen, see **List screen (P.15)**.

Category search

You can search for a file by selecting a category.

- 1 Touch **Category List**.
- 2 Touch the desired category.

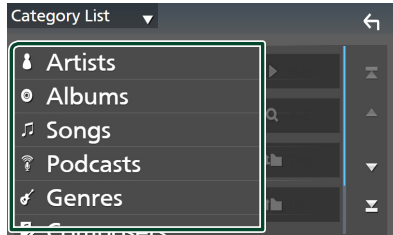

- 3 The list corresponding to your selection appears.

- 3 Touch to select the desired item in the list. Repeat this step until you find the desired file.

Link search (Audio file only)

You can search for a file of the same artist/album/genre/composer as that in the current track.

- 1 Touch **Link Search**.
- 2 Touch the desired tag type. You can select from artists, albums, genres and composers.

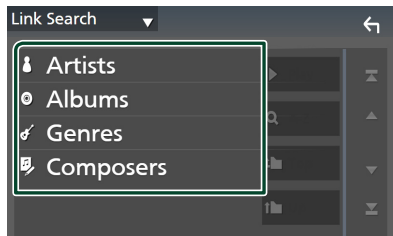

- 3 The list corresponding to your selection appears.

- 3 Touch the desired item in the content list.

Radio (DMX9708S)

Radio Basic Operation

Most functions can be controlled from the source control screen.

To listen to the Radio source, touch **Radio** icon on the source selection screen. (P.12)

NOTE

- Set the remote control mode switch to **AUD** mode before starting operation, see **Switch the operation mode (P.83)**.

Control screen

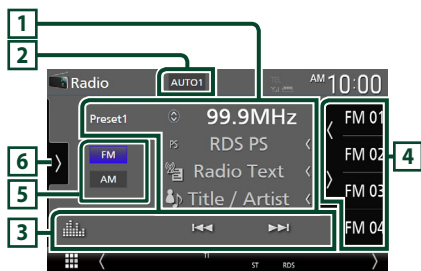

Open the drawer

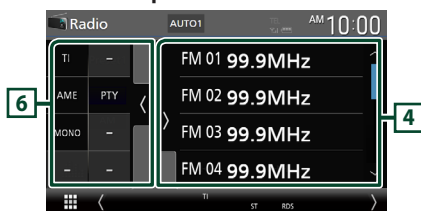

Close the drawer

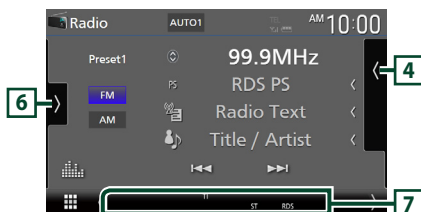

1 Information display

- Displays the information on the current station:
 - Frequency
 - Touching allows you to switch between Content A and Content B.
 - Content A: PS name, Radio Text, Title & Artist
 - Content B: PTY Genre, Radio Text plus
 - Preset#**: Preset number
- Change the text size of the information when the "Small Audio Text" is set to "ON"/"OFF" in the User Interface screen (P.70).

2 Seek mode

Touch to switch seek mode in the following sequence: **AUTO1**, **AUTO2**, **MANUAL**.

- AUTO1**: Tunes in a station with good reception automatically.
- AUTO2**: Tunes in the memorized stations one after another.
- MANUAL**: Switches to the next frequency manually.

3 Operation keys

- : Tunes in a station. The method of switching frequencies can be changed (see **2** Seek mode).
- : Displays the Graphic Equalizer screen. (P.78)

4 Preset list

- Touching allows you to change the display size.
- Recalls the memorized station.
- When touched for 2 seconds, stores the currently being received station in the memory.

5 Band keys

Switches bands (between FM and AM).

6 Function panel

Touch the left side of the screen to display the function panel. Touch again to close the panel.

- TI** (FM only): Selects the traffic information mode. For details, see **Traffic Information (P.33)**.
- AME**: Presets stations automatically. For details, see **Auto memory (P.32)**.

Radio

- **PTY** (FM only) : Searches for a program by program type. For details, see **Search by program type (P.33)**.
- **MONO** (FM only) : Selects the Monaural reception mode.

7 Indicator Items

- **ST** : A stereo broadcast is being received.
- **MONO** : The forced monaural function is active.
- **TI** : Indicates the reception state of traffic information.
 - White: TP is being received.
 - Orange: TP is not being received.

Memory Operation

Auto memory

You can store stations with good reception in the memory automatically.

1 Touch desired band key.

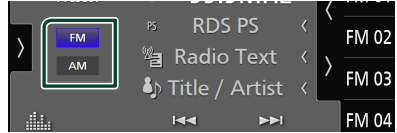

2 Touch on the left side of the screen. Touch **AME**.

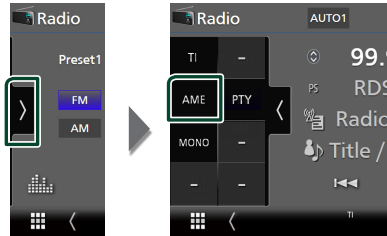

3 Touch **Yes**.

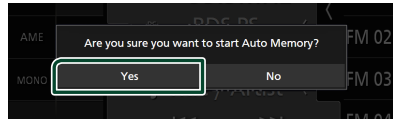

➤ Auto memory starts.

Manual memory

You can store the currently being received station in the memory.

- 1 Select the station you wish to store in the memory.
- 2 Touch **FM#** (#:1-15) or **AM#** (#:1-5) in which you want to store the station for 2 seconds until a beep sounds.

Selecting Operation

Preset select

You can list and select memorized stations.

- 1 Touch  on the right side of the screen. Select a station from the list.

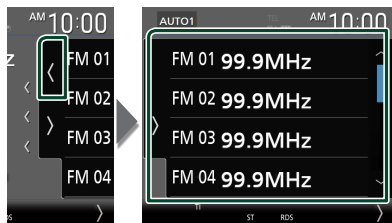

Search by program type (FM only)

You can tune in the station broadcasting the specified type of program when listening to FM.

- 1 Touch  on the left side of the screen. Touch **PTY**.

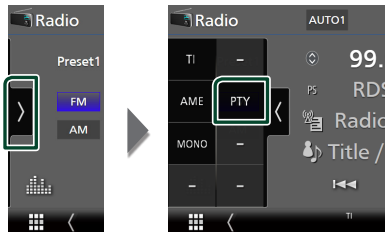

► TUNER PTY Mode screen appears.

- 2 Select a program type from the list.
- 3 Touch **Search**.

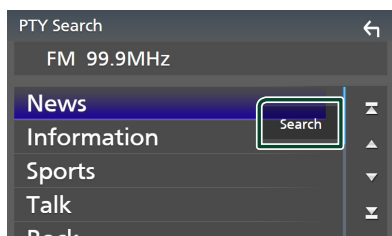

You can search for the station broadcasting the selected type of program.

Traffic Information (FM only)

You can listen to and watch traffic information automatically when a traffic bulletin starts. However, this feature requires a Radio Broadcast Data System that includes TI information.

- 1 Touch  on the left side of the screen. Touch **TI**.

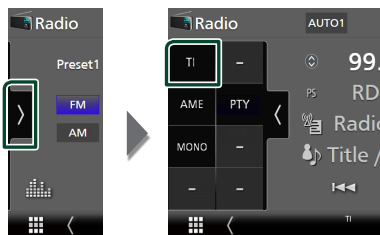

► Traffic information mode is set.

When the traffic bulletin starts

The Traffic Information screen appears automatically.

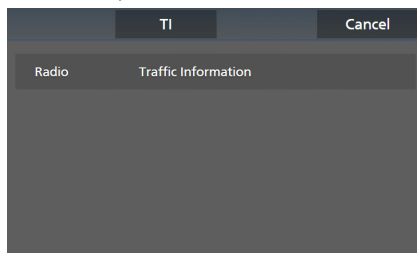

NOTE

- It is necessary to turn on the Traffic Information function in order to allow the Traffic Information screen to appear automatically.
- The volume setting made during reception of traffic information is automatically memorized. When the traffic information is received next time, this unit recalls the volume setting automatically.
- To cancel Traffic Information: Touch **Cancel**.

HD Radio™ Tuner (DMX958XR / DMX908S)

HD Radio Tuner Basic Operation

Most functions can be controlled from the source control screen.

To listen to the HD Radio source, touch **HD Radio** icon on the source selection screen. (P.12)

NOTE

- Set the remote control mode switch to AUD mode before starting operation, see **Switch the operation mode (P.83)**.
- HD Radio broadcasting is for North American sales area only.

Control screen

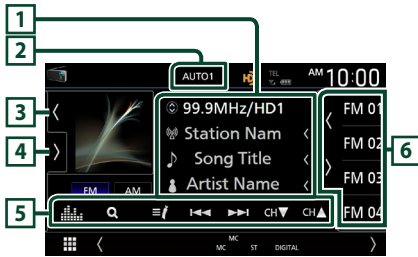

Open the drawer

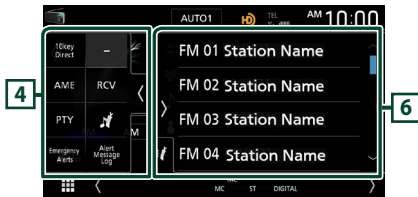

Close the drawer

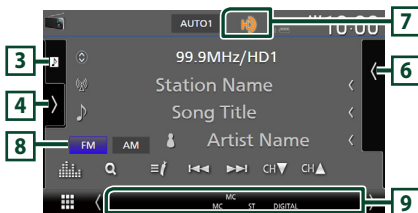

1 Information display

- Displays the information on the current station: Frequency and Channel
- Touching  allows you to switch between Content A, Content B and Content C.
- Content A: Station name, Song Title, Artist Name
- Content B: Station Message, Radio Text
- Content C: PTY Genre, Album Name
- Change the text size of the information when the "Small Audio Text" is set to "ON"/"OFF" in the User Interface screen (P.70).

2 Seek mode

Touch to switch seek mode in the following sequence: **AUTO1** , **AUTO2** , **MANUAL** .

- **AUTO1** :Tunes in a station with good reception automatically.
- **AUTO2** :Tunes in the memorized stations one after another.
- **MANUAL** : Switches to the next frequency manually.

3 Picture

- Displays/hides picture area.
- The picture data or station Logo data is displayed if available from current content.

4 Function panel

Touch the left side of the screen to display the function panel. Touch again to close the panel.

- **10key Direct** : Display the direct station/channel search screen. For details, see **Direct search (P.37)**.
- **AME** : Presets stations automatically. For details, see **Auto memory (P.36)**.
- **RCV** : Change the HD Radio reception mode. For details, see **Receive Mode (P.36)**.
- **PTY** (FM only): Searches for a program by program type. For details, see **Search by program type (P.37)**.
-  : Stores the information about the song being received. See **Bookmark (P.38)**.
- **Emergency Alerts** : Turn on or off the alert message. See **Alert Message (P.39)**.
- **Alert Message Log** : Displays the alert message received. See **Alert Message (P.39)**.

5 Operation keys

- **◀◀ ▶▶** : Tunes in a station. The method of switching frequencies can be changed (see **2** Seek mode).
- **CH▼ CH▲** : Selects a channel.
- **🔍** : Displays the Channel List screen. See **Channel search (P.37)**.
- **📖** : Displays a list of registered bookmarks. See **Bookmark list (P.38)**.
- **📊** : Displays the Graphic Equalizer screen. **(P.78)**

6 Preset list

- Touching **📖/📊** allows you to change the display size.
- Recalls the memorized station or channel.
- When touched for 2 seconds, stores the currently being received station or channel in the memory.

7 Indicator display

While receiving an HD Radio station, it lights with orange when the audio is digital and lights with gray when it is analog. While receiving an analog station, it is off.

8 Band keys

Switches bands (between FM and AM).

9 Indicator Items

- **MC**: A multicast digital broadcast is being received.
- **ANALOG**: An analog broadcast is being received.
- **DIGITAL**: A digital broadcast is being received.
- **ST**: A stereo broadcast is being received.
- **EA**:
 - White: Emergency Alert is on.
 - No light: Emergency Alert is off.
 - Orange: Interrupting or in snooze/ignore state.

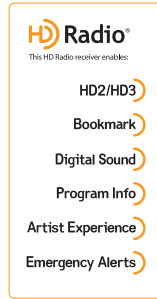

HD2/HD3

- Adjacent to traditional main stations are HD2/HD3 Channels, providing new original programming on the FM dial

Bookmark

- A music & product discovery feature that enables users to store information about content on the radio, and can deliver interactive information via QR codes

Digital Sound

- Crystal clear, CD-like digital audio quality to consumers; eliminates background noise

Program Info

- Provides song name, artist, station ID, and other relevant data to enrich the listening experience

Artist Experience

- Visual images, such as album art of over-the-air broadcasts from HD Radio stations

Emergency Alerts

- Delivers critical and life-saving messages to the public during emergency situations

Receive Mode

You can set the radio broadcasts receive mode.

- 1 Touch **>** on the left side of the screen. Touch **RCV**.

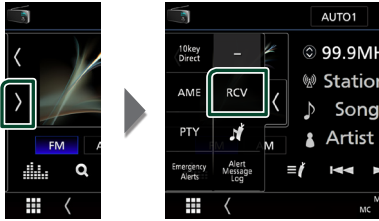

- 2 Select a receive mode.

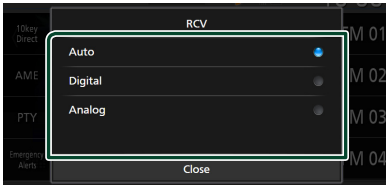

- **Auto**
Switch between digital and analog audio automatically.
- **Digital**
Select this to tune to digital audio only.
- **Analog**
Select this to tune to analog audio only.

Memory Operation

Auto memory

You can store stations with good reception in the memory automatically.

- 1 Touch desired band key.

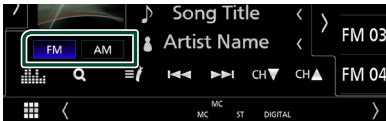

- 2 Touch **>** on the left side of the screen. Touch **AME**.

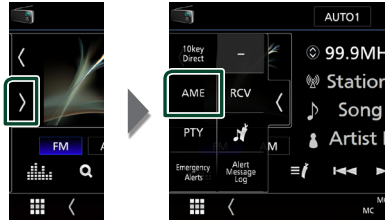

- 3 Touch **Yes**.

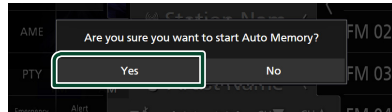

> Auto memory starts.

Manual memory

You can store the currently being received station or channel in the memory.

- 1 Select the station or channel you wish to store in the memory.
- 2 Touch **FM#** (#:1-15) or **AM#** (#:1-5) in which you want to store the station or channel for 2 seconds until a beep sounds.

Selecting Operation

Preset select

You can list and select memorized stations or channels.

- 1 Touch **<** on the right side of the screen. Select a station or channel from the list.



Direct search

You can tune in by entering the desired frequency or channel number.

- 1 Touch **10key Direct** on the left side of the screen. Touch **10key Direct**.

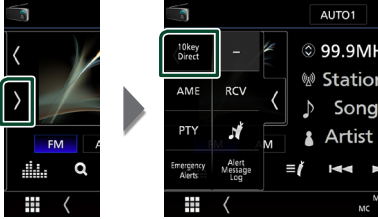

- 2 Select the search method.

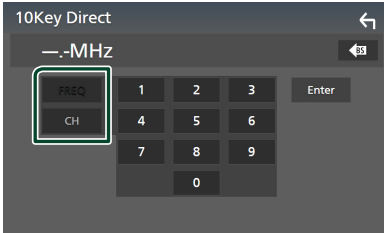

- 3 Enter the frequency or channel number.
- 4 Touch **Enter**.

NOTE

- To clear the number you entered, touch **BS**.

Channel search

You can specify the desired channel.

- 1 Touch **Q**.

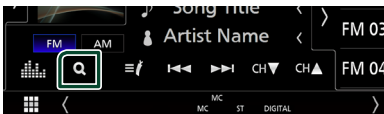

- 2 Select the desired content from the list.

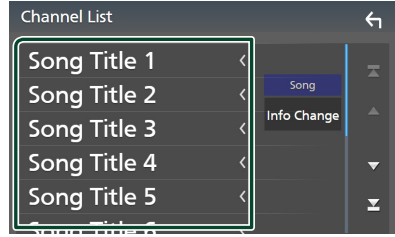

NOTE

- Touch **Info Change** in the channel list. Select the sequence of the list (Song title, artist name, album name).

Search by program type (FM only)

You can tune in the station broadcasting the specified type of program when listening to FM.

- 1 Touch **PTY** on the left side of the screen. Touch **PTY**.

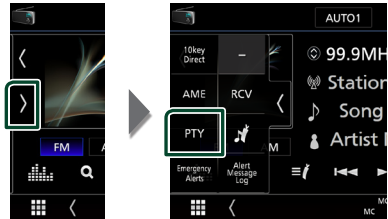

▶ TUNER PTY Mode screen appears.

- 2 Select a program type from the list.
- 3 Touch **Search**.

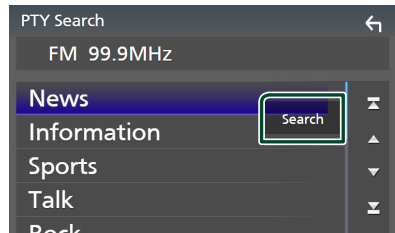



You can search for the station broadcasting the selected type of program.

Bookmark

Stores tag information (title, artist, album, URL, and description) about the song you are listening to now.

Detailed information and QR codes can be displayed according to the stored tag information.

Bookmark registration

- 1 Touch  on the left side of the screen. Touch .

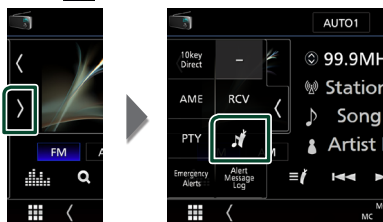

➤ Registers a bookmark.

NOTE

- Up to 100 bookmarks can be registered to this unit.

Bookmark list

Displaying a list of registered bookmarks and detailed information and QR code of the song.

- 1 Touch .

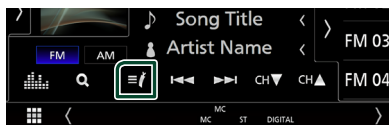

- 2 Select the desired bookmark from the list.

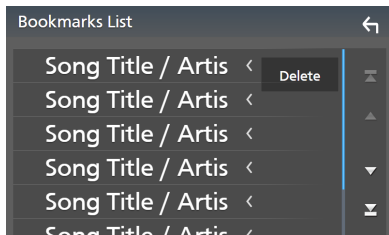

➤ The bookmark information appears.

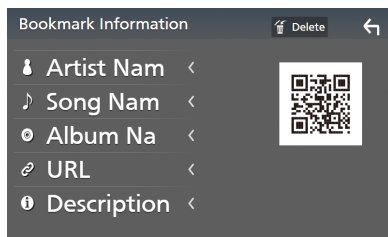

- 1  **Delete**

Deletes the bookmarks being displayed. Touch **Delete** and then touch **Yes** on the confirmation screen.

Bookmark delete

Deleting a bookmark.

- 1 Touch **Delete**.

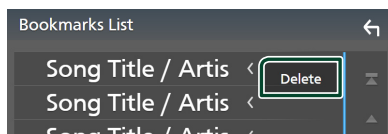

- 2 Select the bookmark to delete from the list.

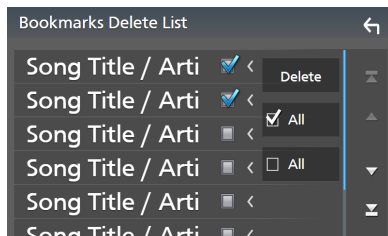

- 1 **All**

Select all bookmarks.

- 1 **All**

Erases all check marks.

- 3 Touch **Delete**.

➤ Confirmation message appears.

- 4 Touch **Yes**.

➤ All the selected bookmark(s) is deleted.

Alert Message

This function is to receive alert messages. First, you need to turn on the “Emergency Alerts”.
(P.34)

When an Alert Message comes



Snooze

The alert message is erased. Same alert message cannot be displayed for next 10 minutes.

Ignore

The alert message is erased. Same alert message cannot be displayed for next 12 hours.

Allow Alert

Touch to tune to that channel of HD Radio source.

Display of the received Alert Message

You can read the received alert message afterward.

- 1 Touch  on the left side of the screen. Touch **Alert Message Log**.

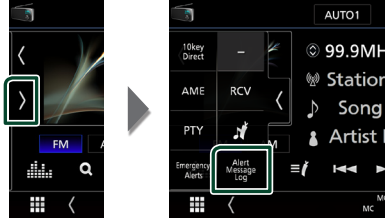

- 2 Select the desired Alert Message from the list.

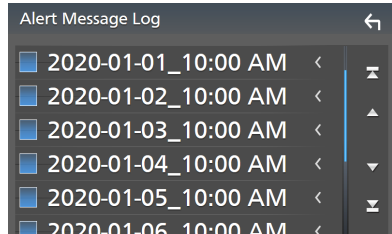

- The Alert Message appears.

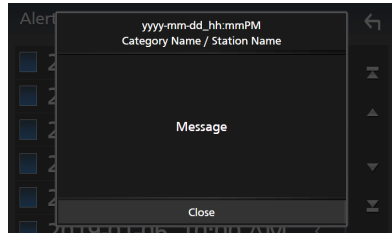

- 3 Touch **Close**.

SiriusXM®

SiriusXM® Basic Operation

Only SiriusXM® brings you more of what you love to listen to, all in one place. Get over 140 channels, including commercial-free music plus the best sports, news, talk, comedy and entertainment. Welcome to the world of satellite radio. A SiriusXM Vehicle Tuner and Subscription are required. For more information, visit www.siriusxm.com. To listen to the SiriusXM source, touch the **SiriusXM** icon on the source selection screen. **(P.12)**

Activating subscription

- Check your Radio ID. The SiriusXM Satellite Radio ID is required for activation and can be found by tuning in Channel 0 as well as on the label found on the SiriusXM Connect tuner and its package. The Radio ID does not include the letters I, O, S or F.
- Activate the SiriusXM Connect Vehicle Tuner using either one of the two methods below. In the USA, you can activate online or by calling SiriusXM Listener care:
 - Visit www.siriusxm.com/activatenow
 - Call SiriusXM Listener Care at 1-866-635-2349
 For Canadian Subscriptions, please contact :
 - Visit www.siriusxm.ca/activate
 - Call SiriusXM Customer Care at 1-888-539-7474

NOTE

- Set the remote control mode switch to AUD mode before starting operation, see **Switch the operation mode (P.83)**.
- To use SiriusXM® Satellite Radio, the optional accessory is necessary.

Control screen

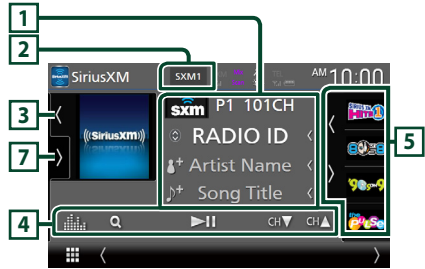

Open the drawer

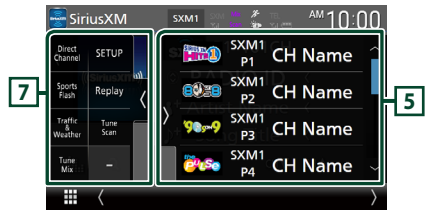

Close the drawer

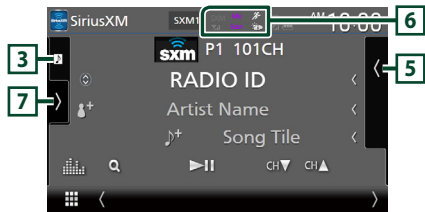

1 Information display

- Displays the information on the current channel: Channel Name
P#: Preset number
#CH: Channel number
Logo: Channel logo
 Touching allows you to switch between Content A, Content B and Content C.
 Content A: Artist Name, Song Title
 Content B: Content Info, Category Name
 Content C: Channel Description, Similar Channels
 : Touch for 2 seconds to register the artist of the current song as a Content Alert.
 : Touch for 2 seconds to register the current song as a Content Alert.
 For details, see **Content Alerts (P.45)**.

- Change the text size of the information when the "Small Audio Text" is set to "ON"/"OFF" in the User Interface screen **(P.70)**.

NOTE

- While getting contents, "Waiting" is showing on the display.

2 Band key

Switches among bands. (SXM1/SXM2/SXM3/SXM4)



3 Artwork

- Displays/hides artwork area.
- Displays the album artwork for most SiriusXM music channels



4 Operation keys

- **Q** : Display the Category search screen. For details on search operation, see **Category/Channel search (P.43)**.
- **▶||** : Plays or pauses. See **Replay (P.43)**.
- **CH▼ CH▲** : Selects a channel.
-  : Displays the Graphic Equalizer screen. **(P.78)**

5 Preset list

- Touching   allows you to change the display size.
- Recalls the memorized channel.
- When touched for 2 seconds, stores the currently being received channel in the memory.

6 Indicator display

Displays the "Mix" (TuneMix™), "Scan" (TuneScan™),  (Traffic&Weather), or  (SportsFlash™) indicator and the received signal strength of the SiriusXM tuner.

7 Function panel





Touch the left side of the screen to display the function panel. Touch again to close the panel.

- **Direct Channel**: Touch and enter the desired number. For details, see **Direct search (P.42)**.
- **SETUP**: Touch to display the SiriusXM SETUP screen. For details, see **SiriusXM SETUP (P.46)**.
- **Replay/Live**: Touch to turn on or off the replay mode. See **Replay (P.43)**.

• Traffic & Weather



For SXV300 *¹

Traffic & Weather Now™ allows you to access the latest report whenever you want to hear it. Select your city from the set up menu (see **Select a City for Traffic & Weather (P.51)**) and touch **Traffic & Weather** to check the latest report. It will start from the beginning.

-  (White) : Played already.
-  (Green) : New information arrived.
-  (Purple) : Playing.
-  (Gray) : No information.

For SXV200 or SXV100 *²

Turns the Traffic & Weather Jump function on or off.

-  (White) : Function on.
-  (Purple) : Playing.
-  (Gray) : Function off.

- **TuneScan** *³ : Allows you to hear a few seconds of songs from each of the SmartFavorite music channels on the current preset band. See **TuneScan™ (P.44)**.
- **TuneMix** *⁴ : When turned ON, shuffles the preset channels on P1-P6 to play a blend of songs from your favorite channels. See **TuneMix™ (P.44)**.
- **SportsFlash** *⁴ : Displays during SportsFlash™. Touch to cancel the SportsFlash™ function and return to the previous channel. See **SportsFlash™ (P.46)** and **SportsFlash™ setup (P.50)**.

*¹ Compatible with SXV300 or later tuner models. It may take a few minutes after power on to get the first full report on your city. Traffic channels are not available in Canada.

*² When SXV200 or SXV100 is connected with this unit.

*³ Compatible with SXV200 or later tuner models.

*⁴ Compatible with SXV300 or later tuner models.

Storing Channels in Preset Memory

You can store the current channel in memory.

- 1 Tune in the channel you wish to store in the memory.
- 2 Touch **CH** on the right side of the screen.



- 3 Touch **SXM(1-4) P(1-6)** in which you want to store the channel for 2 seconds until a beep sounds.

Preset select

You can list and select memorized channels.

To select from the preset list

- 1 Touch **CH** on the right side of the screen. Select a channel from the list.



Direct search

You can tune in a channel directly.

- 1 Touch **Direct Channel** on the left side of the screen. Touch **Direct Channel**.

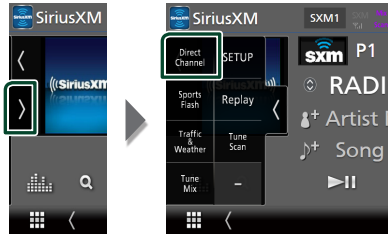

- 2 Enter the channel number and touch **Enter**.

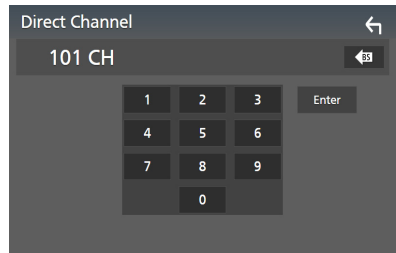

NOTE

- To clear the number you entered, touch **BS**.

Category/Channel search

You can specify the desired category and select a channel.

1 Touch **Q**.

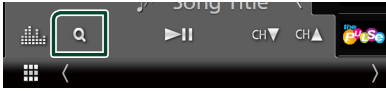

2 Select a category.

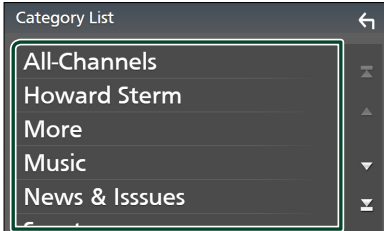

► Channel list appears.

3 Select the desired content from the list.

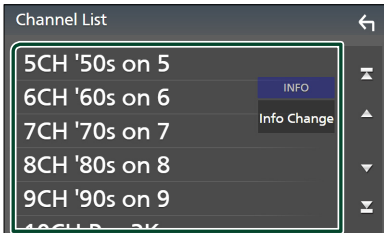

NOTE

- All channels in the selected category appear.
- Touching **All-Channels** displays all channels.
- Touch **Info Change** in the channel list. Select a desired item:
content info, channel name, artist name, song title, category name.
- Categories which have the prefix "Featured -" are Featured Favorites.
- Featured Favorites are groups of channels that are created by the SiriusXM Programming department allowing you to discover new channels. Featured Favorite channels are dynamic and can change often, allowing you to discover new channels.
 - You can set whether to be notified when the featured seasonal theme is updated. **(P.51)**

Replay

You can replay the last 60 minutes of the program from the current channel.

1 Touch **▶II** or **Replay** on the function panel.

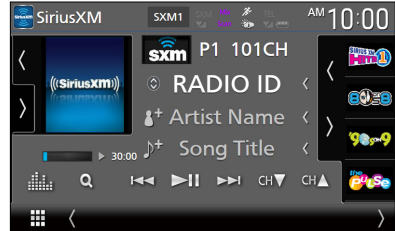

Press to skip to the previous/next track.

Press and hold to rewind or fast forward. (It will be cancelled automatically after about 50 seconds.)



Plays or pauses.

■ **Replay time bar/Play mode indicator**

Displays the recorded data capacity and playback position.

▶, ▶▶, etc.: Current play mode indicator



Displays a list of recorded data on a program basis.

2 Touch **Q** to display an Instant Replay List screen.

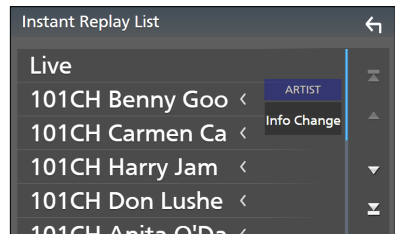

■ **Instant Replay List**

Touching this plays back the displayed program.

Live: Touch to return to the live music/content.

■ **Info Change**

Touch **Info Change**. Select a desired item:
content info, channel name, artist name, song title, category name.

To return to live music/content

- 1 Touch the left side of the screen.
- 2 Touch **Live**.

TuneMix™

TuneMix™ plays a unique blend of songs from your Preset music channels of the current SiriusXM Preset Band, allowing you to build a custom channel from as few as two to as many as 6 music channels. You can even skip songs you don't want to hear.

- 1 Touch **>** on the left side of the screen. Touch **TuneMix** to set ON or OFF.



NOTE

- Compatible with SXV300 or later tuner models.

SmartFavorites, TuneStart™

Preset channels 1 through 6 of the current band are SmartFavorites channels. The SiriusXM Vehicle Tuner automatically buffers the broadcast audio content of the SmartFavorites channels in the background.

You can rewind and replay up to 30 minutes of any of the missed news, talk, sports or music content on SmartFavorites channels. (See **Replay (P.43)**)

When tuning in a SmartFavorites channel, songs will be played from the beginning of each track (TuneStart™). You can enable/disable TuneStart. (See **TuneStart™ (P.51)**)

NOTE

- Compatible with SXV200 or later tuner models.

TuneScan™

TuneScan™ is a feature that plays samples from the starts of multiple buffered songs from each of the SmartFavorites channels that predominantly play music selections. You have easy access to a large sampling of music content and can enjoy hearing a full song by stopping the scan on a song of interest.

- 1 Touch **>** on the left side of the screen.



- 2 Touch **TuneScan** to begin scanning your SmartFavorites channels.

You will hear a few seconds of the songs from each of the SmartFavorite channels.

- 3 While your favorite song is being played, touch **TuneScan** again to start listening to that song.



- Scan finishes and the song is played continuously.

NOTE

- To cancel TuneScan™, touch the left side of the screen. Touch **TuneScan**.
- Touch and hold **TuneScan** to cancel TuneScan, and the music/content which was present on the channel before starting TuneScan will be played.
- Compatible with SXV200 or later tuner models.

Traffic & Weather Now™

Traffic & Weather Now™ allows you to access the latest report whenever you want to hear it. First select your city in the set up menu. See **Select a City for Traffic & Weather (P.51)**.





1 Touch  on the left side of the screen.



2 Touch **Traffic & Weather**.

The report starts from the beginning. To stop and return to the previous channel, touch it again.

Indicator display

-  (White) : Played already.
-  (Green) : New information arrived.
-  (Purple) : Playing.
-  (Gray) : No information.

NOTE

- Compatible with SXV300 or later tuner models.

Content Alerts

When a broadcast program related to the registered artist, song or team starts, an Alert Content List screen appears to allow you to switch the current channel to the relevant channel.

1 When the broadcast of the registered content starts, an Alert Content List screen appears.

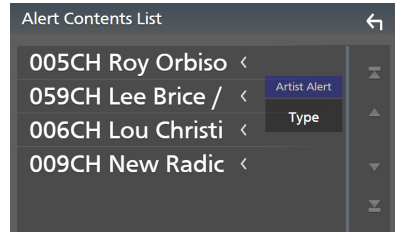

2 Select a content from the list.

NOTE

- Touch **Type**. Select a desired item. Artist Alert, Song Alert, GameAlert™
- To learn how to register artists and songs for the Content Alert function, see  Information display in **SiriusXM® Basic Operation (P.40)**.
- To learn how to set up the Content Alerts function and select Teams for alerts, see **Content Alerts setup (P.48)**.

SportsFlash™

SportsFlash™ will notify you when a big play happens during a game with one of your favorite sports teams. Choose to tune in and hear the play unfold like it was live. Continue listening to the game or return to your previous channel.

- 1 When a big play happens during one of the games, an Alert screen appears.

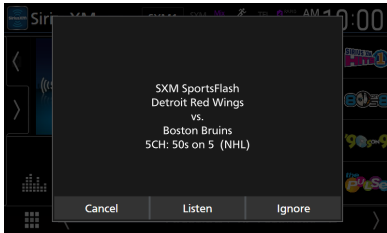

■ Listen

Touch to tune in that channel and play back the big play.

■ Ignore

Touch to cancel this specific SportsFlash alert. Touching **Ignore** will ignore this specific alert but will allow future alerts for this game.

■ Cancel

Touch to cancel SportsFlash alert. No alerts for this game will be displayed afterward.

NOTE

- Compatible with SXV300 or later tuner models.
- To learn how to set up the SportsFlash alert function, see **SportsFlash™ setup (P.50)**.

SiriusXM SETUP

- 1 Touch **SETUP** on the left side of the screen. Touch **SETUP**.

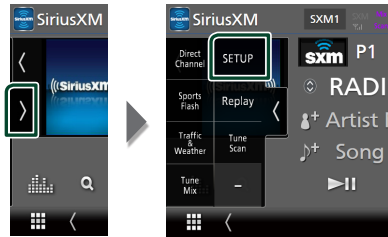

- ▶ SiriusXM SETUP screen appears.

See the following sections for each setting.

- Set up the parental code (**P.47**)
- Set up the Parental Control (**P.47**)
- Set up the skip channel select (**P.48**)
- Set up the Content Alerts (**P.48**)
- Set up the teams for SportsFlash™ (**P.50**)
- Select the city for Traffic & Weather Jump or Traffic & Weather Now™ (**P.51**)
- Select the Featured Bands Update Messages (**P.51**)
- Set up the TuneStart™ (**P.51**)
- Reset to the default settings (**P.51**)

Parental code

You can set a SiriusXM parental code for Parental Control.

1 Touch **Parental Code** on the SiriusXM SETUP screen.

- Parental Pass Check screen appears.

NOTE

- The code number is set to "0000" as default.

2 Enter the current code number and touch **Enter**.

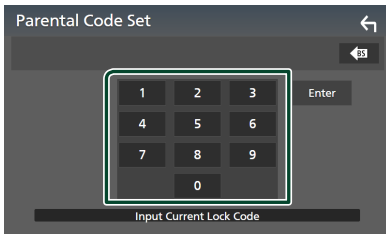

- Parental Pass 1st screen appears.

3 Enter the new code number and touch **Enter**.

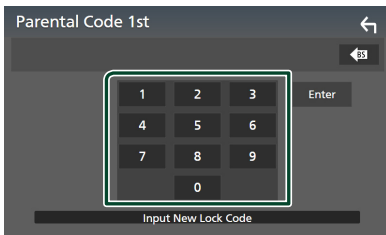

- Parental Pass 2nd screen appears.

4 Enter the same code number as that you entered in step 3 and touch **Enter**.

- The code number is confirmed and the SiriusXM parental code is now set.

Parental Control

Parental Control is a feature that provides the user with the ability to prevent unauthorized access to mature content and user selected channels.

1 Touch **Parental Control** on the SiriusXM SETUP screen.

2 Touch **User, Mature or OFF**.

■ **User**

Locks only the selected channels.

■ **Mature**

Locks channels classified as "mature" only.

■ **OFF**

Deactivates the parental mature and user locks.

3 Enter the parental code you originally input in as stated in *Parental code (P.47)* and touch **Enter**.

When selecting User

This allows you to limit access to any SiriusXM channel (Parental Lock Channel).

1 Touch **Parental Lock Channel Selection** on the SiriusXM SETUP screen.

- Parental Pass Check screen appears.

NOTE

- You need to set up a parental code beforehand as stated in *Parental code (P.47)*.

2 Enter the parental code you originally input as stated in *Parental code (P.47)* and touch **Enter**.

- Parental Lock Category Select screen appears.

3 Touch the desired category in the list.

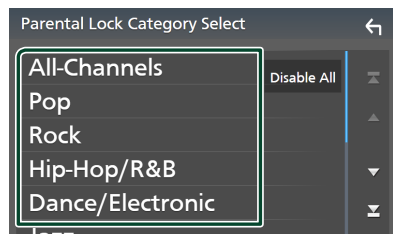

- Displays all channels in the selected category.

NOTE

- Touch **All-Channels** to display all channels.
- To delete the parental lock channel setting, touch **Disable All** and then touch **YES** on the confirmation screen.

4 Touch each channel on the list and set to ON or OFF.

ON: Locks the channel.

OFF: Unlocks the channel.

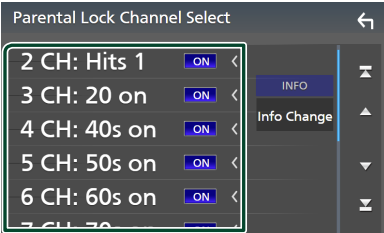

NOTE

- Touch **Info Change**. Select a desired item: content info, channel name, artist name, song title, category name.

Skip channel select

You can set the undesired channels to skip.

1 Touch Skip Channel Select.

- Skip Category Select screen appears.

2 Touch the desired category from the list.

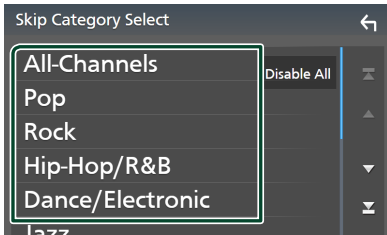

- Displays all channels in the selected category.

3 Touch each channel in the list and set to ON or OFF.

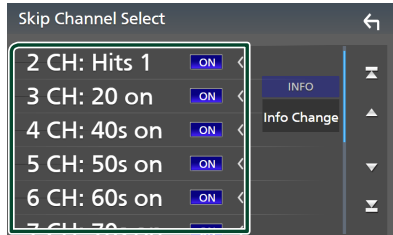

NOTE

- To delete the skip channel setting, touch **Disable All** and then touch **YES** on the confirmation screen.
- Touch **Info Change**. Select a desired item: content info, channel name, artist name, song title, category name.
- Direct Channel and Preset Memory functions allow you to select channels.

Content Alerts setup

Activating content alert

1 Touch Content Alerts on the SiriusXM SETUP screen.

- Content Alerts is turned on or off. Default is "ON".

Selecting the content for Content Alerts

1 Touch Content Alerts Contents Set on the SiriusXM SETUP screen.

2 Select the content you want to set up.

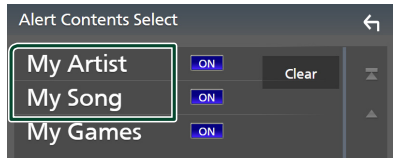

NOTE

- To cancel all alert contents, touch **Clear** and then touch **YES** on the confirmation screen.
- Select **OFF** for the content you want to deactivate the content alert for.

- 3 Touch each content list item you want to check or uncheck.

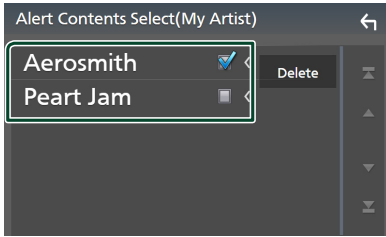

NOTE

• You can select (☑) up to 60 artists or songs.

- **To delete the Artist and Song**

- 1 Touch **Delete**.

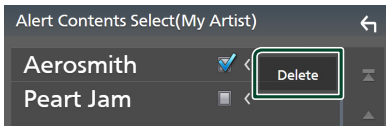

- 2 Touch the content(s) in the list you want to select.

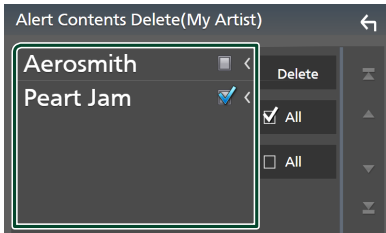

■ **All**
Selects all contents.

■ **All**
Clears all check marks.

- 3 Touch **Delete** and then touch **YES** on the confirmation screen.

To select a Team

Get alerted when your favorite sports team is playing on another SiriusXM channel with GameAlert™

- 1 Touch **My Games**.

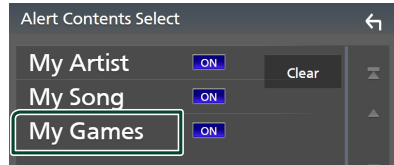

- 2 Touch the desired league in the list.

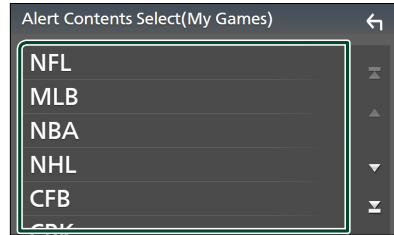

- 3 Touch the team(s) in the list you want to select.

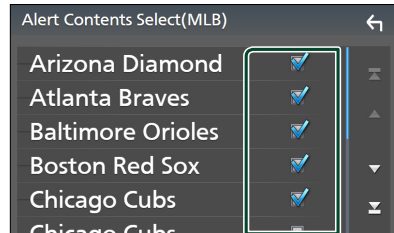

NOTE

• You can select (☑) up to 30 teams.

SportsFlash™ setup

Activating SportsFlash

1 Touch **SportsFlash** on the SiriusXM SETUP screen.

- SportsFlash is turned on or off. Default is "ON".

Selecting SportsFlash Beep

1 Touch **SportsFlash Beep** on the SiriusXM SETUP screen.

- SportsFlash Beep is turned on or off. Default is "ON".

Selecting the teams for SportsFlash

1 Touch **SportsFlash Team Set** on the SiriusXM SETUP screen.

- Team Set screen appears.

2 Touch **Edit**.

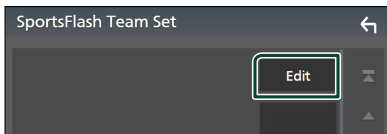

3 Touch the desired league in the list.

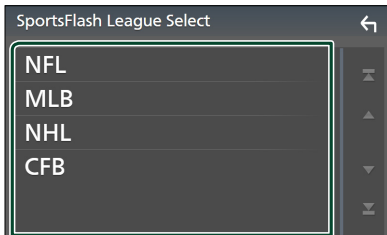

4 Touch each team(s) in the list you want to select.

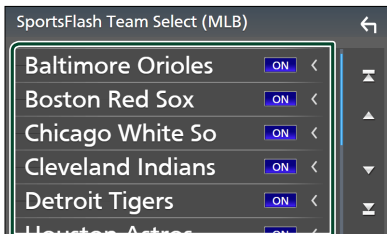

5 Touch  twice.

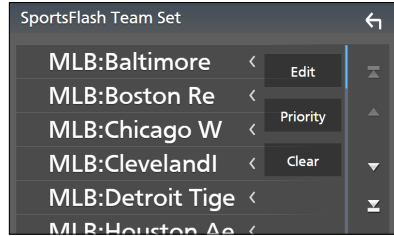

■ Edit

Sets and removes teams.

■ Priority

Sets the priority of a team.

■ Clear

Removes all teams that have been set.

Touch **Clear**. When the confirmation screen appears, touch **YES**.

NOTE

- SportsFlash™ is available on SXV300 or later tuner models.
- Up to 50 teams can be added.

Set the SportsFlash™ Team Priority

1 Touch **Priority**.

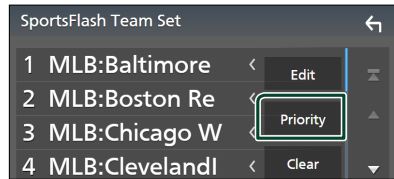

2 Set the priority of a team.

Each time you touch a Team, the priority is set of reset.

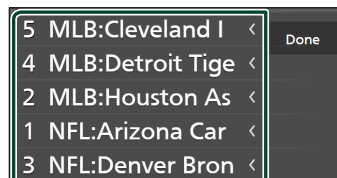

3 Touch **Done**.



NOTE

- Priority can be set on up to 5 teams.
- When priority has already been set for 5 teams, it cannot be set for any other team. Delete an unnecessary team.

Select a City for Traffic & Weather

You can select a city for which you wish to receive SiriusXM Traffic & Weather broadcasts and hear them from the beginning.

- 1 Touch **Traffic & Weather City Select** on the SiriusXM SETUP screen.
- 2 Touch ◀ and ▶ to select a city.

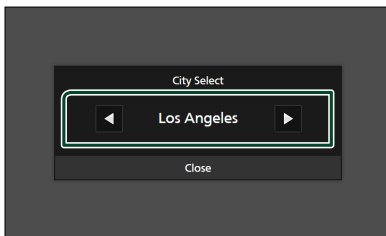

3 Touch **Close**.

Selecting Featured Bands Update Messages

You can set whether to be notified when the featured seasonal theme is updated.

- 1 Touch **Featured Bands Update Messages** on the SiriusXM SETUP screen. Featured Bands Update Messages is turned on or off.

TuneStart™

- 1 Touch **Tune Start** on the SiriusXM SETUP screen.
The TuneStart is turned on or off.
Default is "ON".

Reset

- 1 Touch **SiriusXM Reset** on the SiriusXM SETUP screen.
➤ Confirmation screen appears.
- 2 Touch **YES**.
➤ All SiriusXM settings are reset to defaults.

Bluetooth Control

Using the Bluetooth function allows you to use various functions such as listening to the audio file and making/receiving a call.

Information for using Bluetooth® devices



Bluetooth is a short-range wireless radio communication technology for mobile devices such as smartphones/cell-phones, portable PCs, and other devices.

Bluetooth devices can be connected without cables and communication with each other.

NOTE

- While driving, do not perform complicated operations such as dialing numbers, using the phonebook, etc. When you perform these operations, stop your car in a safe place.
- Some Bluetooth devices may not be connected to this unit depending on the Bluetooth version of the device.
- This unit may not work for some Bluetooth devices.
- Connecting conditions may vary depending on your environment.
- Some Bluetooth devices are disconnected when this unit is turned off.
- The Bluetooth devices cannot be used while using Apple CarPlay.
- The Bluetooth currently connected with other device is disconnected when an iPhone compatible with Apple CarPlay is connected.

About the smartphone/cell-phone and Bluetooth audio device

This unit conforms to the following Bluetooth specifications:

Version

Bluetooth Ver. 5.0

Profiles

Smartphone/Cell-phone:

HFP (V1.7) (Hands Free Profile)

SPP (Serial Port Profile)

PBAP (Phonebook Access Profile)

Audio device:

A2DP (Advanced Audio Distribution Profile)

AVRCP (V1.6) (Audio/Video Remote Control Profile)

Sound codec

DMX958XR: SBC / AAC / LDAC™

DMX908S / DMX9708S: SBC / AAC

NOTE

- The units supporting the Bluetooth function have been certified for conformity with the Bluetooth Standard according to the procedure prescribed by Bluetooth SIG.
- However, it may be impossible for such units to communicate with your smartphone/cell-phone depending on its type.

Register the Bluetooth device

It is necessary to register the Bluetooth audio device or smartphone/cell-phone in this unit before using the Bluetooth function.

You can register up to 10 Bluetooth devices.

NOTE

- Up to 10 Bluetooth devices can be registered. If an attempt is made to register the 11th Bluetooth device, the Bluetooth device connected on the earliest date will be deleted to register the 11th one.
- This unit is compatible with the Apple Easy Pairing function. When an iPod touch or iPhone connected via USB terminal previously is connected again, an authentication dialog appears. Performing operation for authentication on this unit, or iPod touch or iPhone registers the smartphone as a Bluetooth device.

1 Press the **MENU** button.

- Pop-up menu appears.

2 Touch **SETUP**.



- SETUP Menu screen appears.

3 Touch **Connection**.

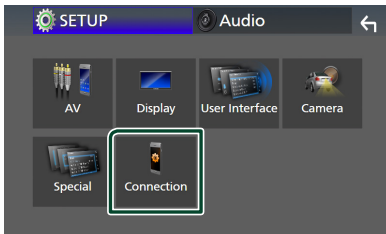

- Connection Setup screen appears.

4 Touch **Device List** on the Connection Setup screen.

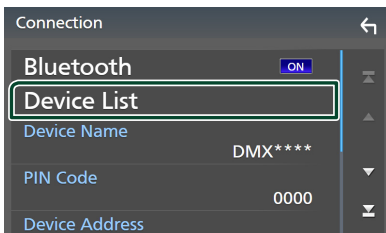

5 Touch **+0** on the Device List screen.

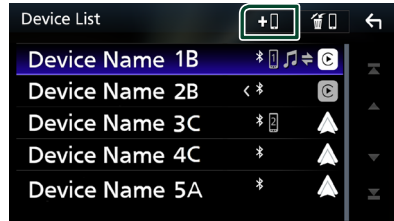

- Bluetooth pairing waiting dialog appears.

NOTE

- If an Apple CarPlay device is currently connected, the Apple CarPlay device will be disconnected.
- When neither Apple CarPlay, Android Auto, nor a Bluetooth Hands-Free phone is connected, pressing and holding the  button displays Bluetooth pairing waiting dialog.

6 Search for the unit ("DMX****") from your smartphone/cell-phone.

Complete steps 6 to 8 within 30 seconds.

7 Operate your smartphone/cell-phone according to the displayed messages.

- **Confirm the request both on the smartphone/cell-phone.**

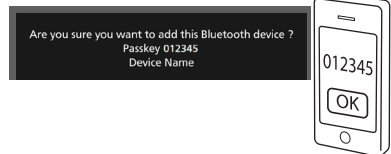

- **Input the PIN Code in your smartphone/cell-phone.**

PIN Code is set to "0000" as the default.

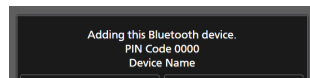

8 Touch **Yes**.

When data transmission and connection have completed, the Bluetooth connection icon appears on the screen.

NOTE

- When registering the iPhone that is available for Apple CarPlay wirelessly, a confirmation message appears.
 - **Yes**: Displays the Apple CarPlay screen for wireless connection.
 - **No**: Apple CarPlay is not connected. When using Apple CarPlay, see **Select an Apple CarPlay device (P.21)**.
- The device name selected on step 6 can be changed. See **Change the device name for Bluetooth (P.74)**.

Switch the connected device

If two or more Bluetooth devices have been registered, select the device to be used.

- 1 Touch Device List on the Connection Setup screen.**
- 2 Touch the name of the device you want to connect.**

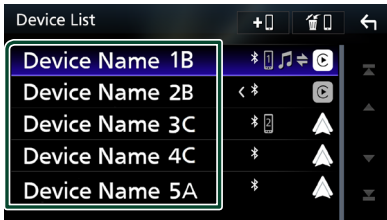

NOTE

- If the icon is lighted, it means that the unit will use that device.
- You can confirm the connection status of Bluetooth, Apple CarPlay or Android Auto as follows.
 - Bluetooth: If the device compatible with Bluetooth is paired, (Blue), (Blue) or (Blue) is lighted.
 - Apple CarPlay: If the device compatible with Apple CarPlay is connected, the device name (Blue) and (White) are lighted.
 - Android Auto: If the device compatible with Android Auto is connected, the device name (Blue) and (White) are lighted.
- Even if the device is compatible with Apple CarPlay or Android Auto, icons are not displayed when;
 - Apple CarPlay is deactivated on the connected device side.
 - The connected device only supports wired Android Auto.
- If you select a device name to which the Apple CarPlay/Android Auto is connected, it will be disconnected.
- You can quickly display the Device List screen by touching in the popup menu. **(P.11)**

To switch the connected device to a Bluetooth device

- 1 Touch the icon area on the right side of the Bluetooth device name you want to connect.

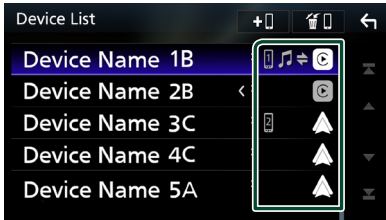

NOTE

- In the following cases, a confirmation message for disconnection appears. Touch **Yes** and follow to next step 2.
 - Select any device when Apple CarPlay is connected.
 - Select the connected device when Android Auto is connected.

- 2 Set each profile as follows.

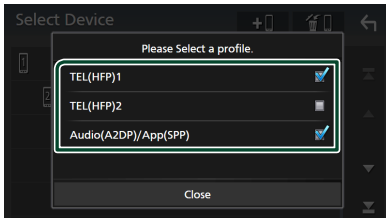

■ TEL (HFP) 1 , TEL (HFP) 2

Select when the device is connected with the unit as a Hands-Free phone 1 or 2.

■ Audio (A2DP)/App (SPP)

Select to use as an audio device or to interwork with an application installed in a smartphone.

- 3 Touch **Close**.

To delete the registered device

You can delete the device that is registered in device list.

- 1 Touch  on the Device List screen.



- 2 Touch the device name to check.

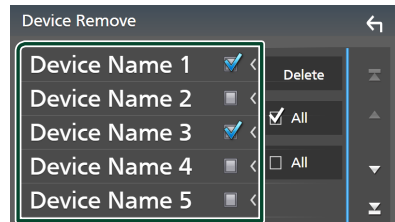

■ All

Selects all Bluetooth devices.

■ All

Clears all check marks.

NOTE

- The following devices are not deleted.
 - Wired Apple CarPlay device which is not paired
 - Connected Android Auto device

- 3 Touch **Delete**.

➤ Confirmation message appears.

- 4 Touch **Yes**.

➤ All the selected device(s) is deleted.

Playing the Bluetooth Audio Device

Most function can be controlled from the source control screen.

To select Bluetooth source, touch **Bluetooth Audio** icon on the source selection screen. (P.12)

NOTE

- The Bluetooth audio source is disabled while using Apple CarPlay.
- The Bluetooth audio source is disabled when the device set as Audio(A2DP)/App(SPP) is using Android Auto.

Bluetooth basic operation

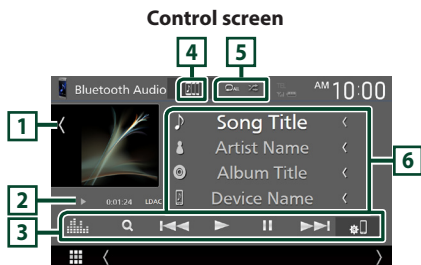

1 Artwork/VU meter

- Displays/hides artwork area.
- Touch to switch between the artwork and VU meter.

2 Play mode indicator/Playing time

▶, ||: Current play mode indicator

Meanings of individual icons are as follows:

- ▶ (play), ▶▶ (fast forward), ◀◀ (fast backward), || (pause), ■ (stop).

LDAC (DMX958XR): Indicates that an LDAC-compatible device is connected.

3 Operation keys *

- 🔍: Searches for a file. See **File search** (P.57).
- ◀◀ ▶▶: Searches for the previous/next content.
Touch and hold to fast forward or fast backward. (It will be cancelled automatically after about 50 seconds.)
- ▶: Plays.

- ||: Pauses.
- 📶: Displays the Connection Setup screen. (P.73)
- 📊: Displays the Graphic Equalizer screen. (P.78)

4 KENWOOD Music Mix

Bluetooth audio devices can be switched easily to play music. See **KENWOOD Music Mix** (P.57).

5 Repeat/Random *

- 🔄: Repeats the current track/folder. Each time you touch the key, repeat modes are switched in the following sequence: File repeat (🔄), Folder repeat (🔄), All songs repeat (🔄), Repeat off (🔄)
- 🎲: Randomly plays all tracks in the current folder. Each time you touch the key, random modes are switched in the following sequence: Folder random (🎲), All random (🎲), Random off (🎲)

6 Information display *

- Displays the name of track information.
- Connected device name.
- Change the text size of the information when the "Small Audio Text" is set to "ON"/"OFF" in the User Interface screen (P.70).

* These items appear only when the audio device which supports AVRCP profile is connected.

NOTE

- The operation keys, indications and information displayed on the screen differ depending on the connected device.
- If the operation keys do not appear, operate from the device.
- Depending on your smartphone/cell-phone or audio device, sound may be heard and controlled but text information may not appear.
- If the volume is too low, raise it on your smartphone/cell-phone or audio device.
- It is recommended that you change the playback quality from "priority on sound quality" to "priority on stable connection" in the settings of your LDAC-compatible device so that the intermittent sound problem is less likely to occur. (DMX958XR)



KENWOOD Music Mix

Up to 5 Bluetooth audio device can be connected and switched easily to play music.



1 Touch .

➤ A list of registered devices is displayed.

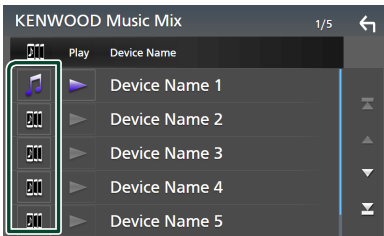

2 Touch of device name you want to connect.

- Touching  displays the Device List screen. (P.54)
- Touching  on the left of the connected device () disconnects this device.





-  : Device used normally.
-  : Device used for KENWOOD Music Mix

3 Touch (white) on the left of the name of the device to be played.

 (white) changes to  (purple) and starts playback.



-  (Gray) : Not connected.
-  (White) : Connected.
-  (Purple) : During playback.

4 Touch .

NOTE

- If a connected Bluetooth audio device is operated to play music, connections are switched.
- When a Bluetooth source is switched to another one, its settings are deleted and the connection is restored to the connection before source switching.
- You cannot select an Android smartphone connected as an Android Auto device.

File search

1 Touch .

2 Touch the desired file or folder.

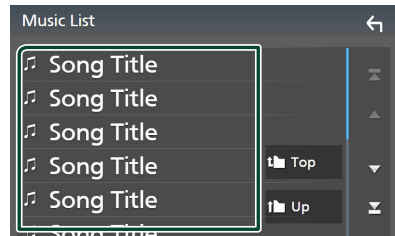

When you touch a folder its contents are displayed.

3 Touch the desired item in the content list.

➤ Playback starts.

NOTE

- For operations in the list screen, see *List screen* (P.15).

Using the Hands-Free Unit

You can use the telephone function by connecting the Bluetooth telephone to this unit.

NOTE

- If you use the Hands-Free function frequently, move the TEL short-cut key (icon) to the Home screen. **(P.13)**
- While using the Bluetooth Hands-Free function, Apple CarPlay or Android Auto is not available.
- While Apple CarPlay or Android Auto is connected, the Bluetooth Hands-Free function and two Bluetooth devices connections cannot be used. Only the Apple CarPlay or Android Auto Hands-Free function can be used.

Make a call

1 Press the **HOME** button.

2 Touch .

3 Touch **TEL**.







► Hands-Free screen appears.

NOTE

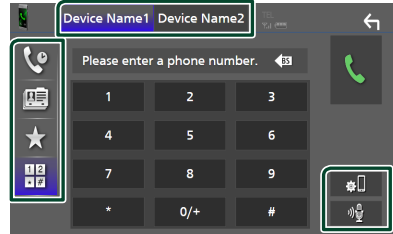
- If your smartphone/cell-phone supports PBAP, you can display the phonebook and call lists onto the touch panel screen when the smartphone/cell-phone is connected.
 - Phonebook: up to 1000 entries
 - Up to 50 entries including dialed calls, received calls, and missed calls



4 Select a dialing method.



- : Call using call records
- : Call using the phonebook
- : Call using the preset number
- : Call by entering a phone number

● **Select the smartphone/cell-phone to use**

When you connect two smartphones/cell-phones

1) Touch   to select the phone you want to use.

● **Connection Setup**

1) Touch .
Connection Setup screen appears.

● **Voice Recognition**

1) Touch . **(P.60)**

NOTE



- Status icons such as battery and antenna icons may differ from those displayed on the smartphone/cell-phone.
- Setting the smartphone/cell-phone in the private mode can disable the Hands-Free function.

Call using call records

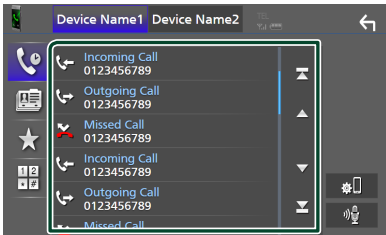
- 1 Touch .
- 2 Select the phone number from the list.



Call using the phonebook

- 1 Touch .
- 2 Touch  **A-Z**.
- 3 Select the initial.

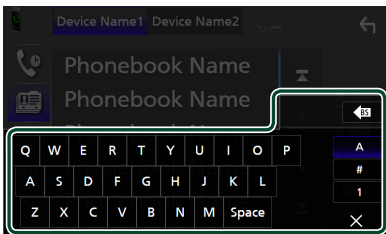

- Characters with no corresponding name will not appear.
- A first character with an accent character such as “ü” can be searched for with a non-accent character “u”. A character with an accent character in a sentence cannot be searched for.

- 4 Select the person you want to call from the list.

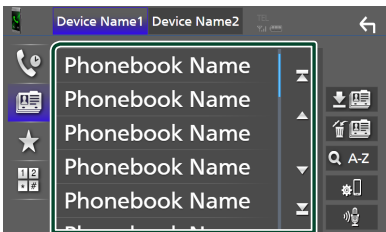

- 5 Select the phone number from the list.

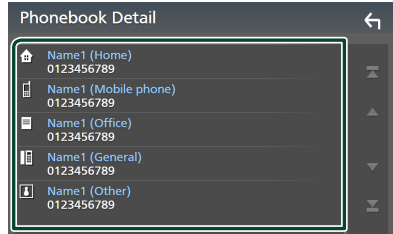

NOTE

- You can sort the phone numbers in the list by last name or first name. For details, see **Hands-Free Setup (P.63)**.

Call using the preset number

- 1 Touch .
- 2 Touch the name or phone number.

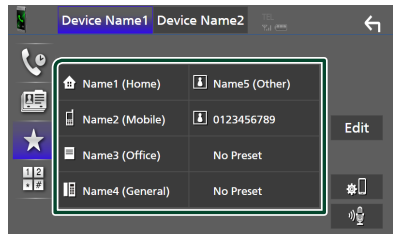

Call by entering a phone number

- 1 Touch .
- 2 Enter a phone number with number keys.

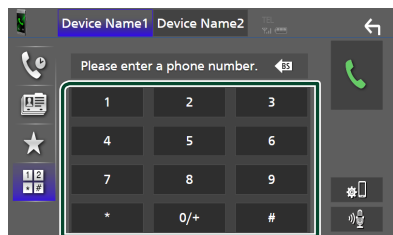

- 3 Touch .

Voice Recognition

You can access the voice recognition function of the smartphone/cell-phone connected to this unit. You can search the smartphone/cell-phone phonebook by voice. (The functionality depends on the smartphone/cell-phone.)

1 Press the  button for 1 second.

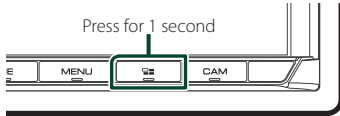



➤ Voice Recognition screen appears.

2 Start speaking.

NOTE

- You can use the voice recognition function by touching  on the Hands-Free screen.
- You can use the voice recognition function for the connected smartphone/cell-phone if you selected **Hands Free1** or **Hands Free2** for HFP when registered.

Receive a call

1 Touch  to answer a phone call or  to reject an incoming call.

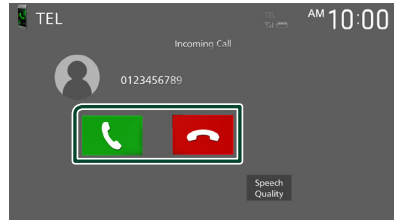

NOTE

- When shifting the gear to the reverse (R) position and monitoring the picture from the rear view camera, this screen does not appear even if a call comes in.
- The portrait registered in the phonebook is displayed while making/receiving calls and during a call.
- If you edit the phonebook on the connected device side after downloading the phonebook, the portrait may not be displayed depending on the edited content. It is recommended that you download the phonebook whenever you edit it.
- The image quality of a displayed portrait may depend on a connected device.

To end call

- 1 While talking, touch .

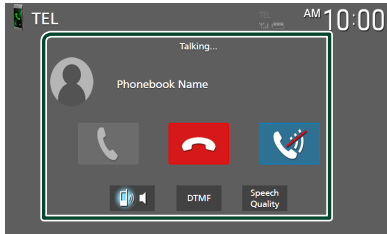
Operations during a call

- **Adjust the volume of your voice**

- 1) Touch **Speech Quality**.
- 2) Touch ◀ or ▶ for **Microphone Level**.

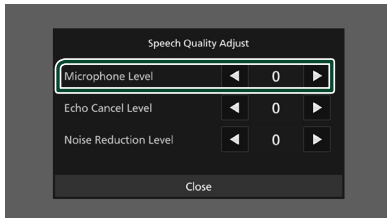

- **Adjust the receiver volume**

Press the ▼ or ▲ button.

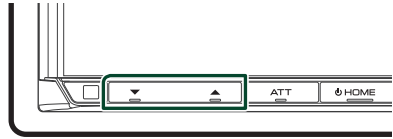

- **Mute your voice**

Touch  to mute or not to mute your voice.

- **Output the dial tone**

Touch **DTMF** to display the tone input screen. You can send tones by touching desired keys on the screen.

- **Switching between speaking voice output destinations**

Touching  /  each time switches speaking voice output destinations between the smartphone/cell-phone and the speaker.

- **Call-waiting**

When you receive a new call while talking on the phone, you can answer the newly received call by touching . The current call is put on hold.

Each time you touch , the caller will change to the other one.

When you touch , the current call will end to be switched to the call waiting on hold.

Bluetooth Control

Phone number preset

You can register frequently used phone numbers in this unit.

1 Touch .

2 Touch **Edit**.

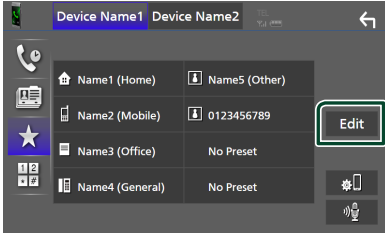

3 Select where to preset.

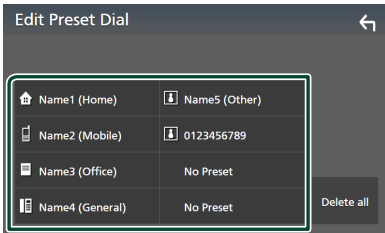

Delete all

To delete all preset numbers, touch **Delete all** and then touch **OK** on the confirmation screen.

4 Select how to preset.

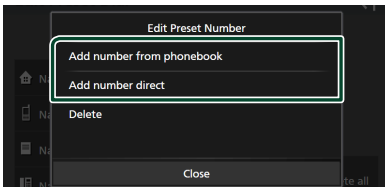

Add number from phonebook

Select the number to preset from the phonebook. See **Call using the phonebook (P.59)**.

Add number direct

Enter the telephone number directly and touch **SET**. See **Call by entering a phone number (P.59)**.

Delete

To delete a preset number, touch **Delete** and then touch **OK** on the confirmation screen.

Phonebook transfer

You can transfer phonebook data from your Bluetooth smartphone using PBAP.

1 Touch .

2 Touch .

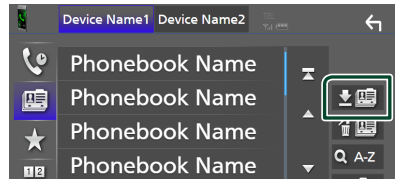

> Phonebook data transfer starts.

NOTE

- If the Phonebook contains more than 1000 entries, only 1000 entries are transferred. The 1001st and later entries are not transferred.
- If no Phonebook has been downloaded, touching **Download Phonebook Now** will start downloading the Phonebook.
- The portrait registered in the phonebook is displayed while making/receiving calls and during a call.
If you edit the phonebook on the connected device side after downloading the phonebook, the portrait may not be displayed depending on the edited content. It is recommended that you download the phonebook whenever you edit it.

Phonebook deletion

- 1 Touch .
- 2 Touch the name to check.

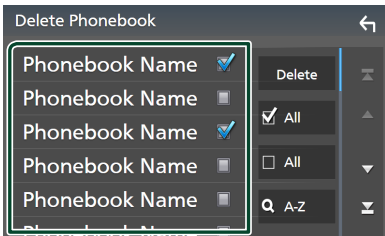

- **All**
Checks all boxes.
 - **All**
Clears all check marks.
- 3 Touch **Delete**.
➤ Confirmation message appears.
 - 4 Touch **OK**.

Hands-Free Setup

You can make various settings for the Hands-Free function.

- 1 Press the **MENU** button.
➤ Pop up menu appears.
- 2 Touch **SETUP**.



➤ SETUP Menu screen appears.

- 3 Touch **Connection**.

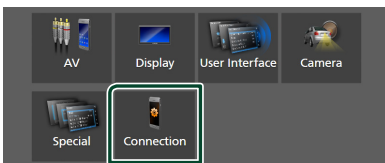

➤ Connection Setup screen appears.

- 4 Touch **TEL SETUP**.
➤ TEL SETUP screen appears.

- 5 Set each function as follows.

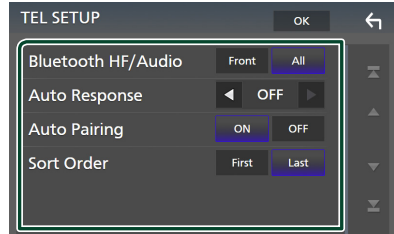

■ Bluetooth HF/Audio

Select the speakers to output the sound from the smartphone/cell-phone (such as phone call voice and ringing tone) and Bluetooth audio device.

Front: Outputs sound from the front speakers.

All (Default): Outputs sound from all speakers.

■ Auto Response*

Set the automatic response time to pick-up an incoming call.

OFF (Default): Turns off the Automatic response function.

1/5/10/15/20/25/30: Sets the ringing time (second).

■ Auto Pairing

When set to "ON", the Apple Auto Pairing function is turned on to automatically register the iPod touch or iPhone connected to this unit.

ON (Default): Turns on the Apple Auto Pairing function.

OFF: Turns off the Apple Auto Pairing function.

■ Sort Order

Set how to sort the data in the smartphone/cell-phone phonebook.

First (Default): Sorts data by the first name.

Last: Sorts data by the last name.

* Either the auto response time set on this unit or the time set on the smartphone/cell-phone, whichever is shorter takes effect.

- 6 Touch **OK**.

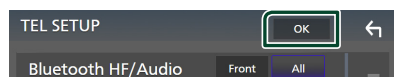

Other External Components

View Camera

NOTE

- To connect a camera, see **Connecting the camera (P.94)**.
- To use a rear view camera, a REVERSE lead connection is required. **(P.91)**
- If **Rear Camera Interruption** is active the camera screen is displayed when you shift the gear to the reverse (R) position.
- The camera whose view was displayed last is kept and the same camera view will be displayed the next time. If its assignment setting is changed, the rear camera view is displayed.
- Rear/front camera interruption screen is not kept as the camera screen which will be displayed the next time.

Display the camera screen

1 Press the **MENU** button.

- Popup menu appears.

2 Touch **Camera**.

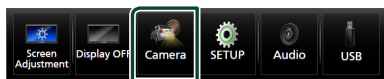

- View camera screen appears.

3 Adjust each item as follows.

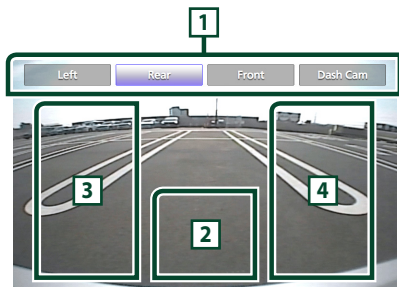

1 **Camera Switching Keys** *1

Touch to switch the view camera. It is necessary to set "Camera Assignment Settings" beforehand except "Rear". See **To set up the camera assignment settings (P.65)**.

2 **Camera off**

Touch to exit the camera screen.

3 **Switching the Guideline** *2

Touching each time turns on or off the guideline.

4 **Switching the Angle** *2

Touching each time changes camera angles.

*1 When two or more cameras of rear, front, dashboard, left, right, and 3rd are connected with this unit.

*2 Only when the rear camera screen is displayed and CMOS-3xx series is connected with this unit as the rear camera.

Camera Setup

1 Press the **MENU** button.

- Popup menu appears.

2 Touch **SETUP**.

- SETUP Menu screen appears.

3 Touch **Camera**.

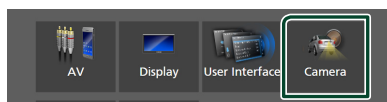

- Camera screen appears.

4 Set each item as follows.

■ **Camera Assignment Settings**

Set up the camera assignment. See **To set up the camera assignment settings (P.65)**.

■ **Rear Camera Interruption**

ON (Default): Displays the picture from the rear view camera when you shift the gear to the reverse (R) position.

OFF: Select this when no camera is connected.

■ **Rear Camera Message** *1

Always display (Default): Always displays the caution message on the rear camera interruption screen.

Clear after 5 seconds: Displays the caution message for about 5 seconds on the rear camera interruption screen.

■ **Rear Camera Settings** *2

Adjusts the CMOS-3xx series with ID 1 ("Rear Camera") set. For details, see the instruction manual of your camera.

■ **Parking Guidelines**

You can display parking guidelines to enable easier parking when you shift the gear to the reverse (R) position.

Default is "ON".

■ **Guidelines SETUP**

If you select **ON** for **Parking Guidelines**, you can adjust the parking guidelines. See **To adjust the parking guidelines (P.66)**.

■ **Front Camera Settings** *3

Adjusts the CMOS-3xx series with ID 2 ("Front Camera") set. For details, see the instruction manual of your camera.

■ **Front Camera Interruption** *4

10 sec / 15 sec (Default) / **20 sec**: The front camera screen is displayed when return the gear from the reverse (R) position.

OFF: Cancel.

*1 To use the function, it is necessary to set **Rear Camera Interruption** to **ON**.

*2 When CMOS-3xx series is connected with this unit.

*3 To use the function, it is necessary to connect CMOS-3xx series and to set **Camera Assignment Settings** to **Front**. (P.65)

*4 To use the function, it is necessary to set **Rear Camera Interruption** to **ON** and to set **Camera Assignment Settings** to **Front**. (P.65)

■ **To set up the camera assignment settings**

1 Touch **Camera Assignment Settings** on the Camera screen. (P.64)

2 Select the item to set up.

■ **REAR VIEW CAMERA (DMX958XR)**

Change the HD camera picture quality setting when an HD camera is connected.

■ **FRONT VIEW CAMERA / DASH CAM**

Set the camera assignment from view camera connected to Front view camera / Dashboard camera input terminal.

Change the HD camera picture quality

setting when an HD camera is connected. (DMX958XR only)

■ **3rd VIEW CAMERA**

Set the camera assignment from view camera connected to 3rd view camera input terminal.

■ **AV-IN**

Set the camera assignment from view camera connected to VIDEO input terminal.

3 Select the view camera to set up.

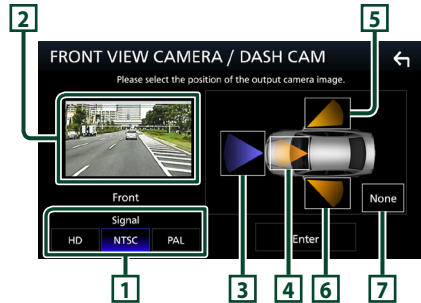

1 **Picture quality settings** (DMX958XR) *1

Switch the picture quality setting when an HD camera for the rear/front view camera is connected.

"HD"/"NTSC" (Default) / "PAL"

2 **Picture from view camera**

Displays the picture from the view camera connected to the input terminal to be set. (P.94)

3 **Front** *2

Assign front position to the view camera connected to the selected input terminal.

4 **Dashboard Camera** *2

Assign dashboard camera position to the view camera connected to the selected input terminal.

5 **Right** *2

Assign right position to the view camera connected to the selected input terminal.

6 **Left** *2

Assign left position to the view camera connected to the selected input terminal.

7 None *2

Assign no position to the view camera connected to the selected input terminal.

*1 The **REAR VIEW CAMERA** and **FRONT VIEW CAMERA / DASH CAM** setting screens only.

*2 Except the **REAR VIEW CAMERA** setting screen.

4 Touch Enter.

NOTE

- The screen shot is for the **FRONT VIEW CAMERA / DASH CAM** setting screen. It may be different from the ones for **REAR VIEW CAMERA**, **3rd VIEW CAMERA** and **AV-IN**.
- The Dashboard Camera can be selected when it is connected. (P.94)

To adjust the parking guidelines

NOTE

- Install the rear view camera in the appropriate position according to the instruction manual supplied with the rear view camera.
- When adjusting the parking guidelines, make sure to apply the parking brake to prevent the car from moving.

1 Touch Parking Guidelines in the Camera screen and set to ON . (P.64)

2 Touch Guidelines SETUP on the Camera screen.

3 Adjust the parking guidelines by selecting the  mark.

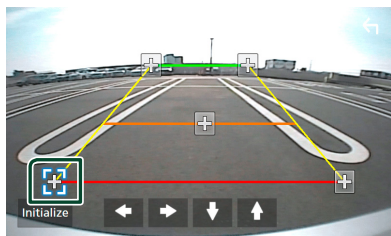

4 Adjusting the position of the selected mark.

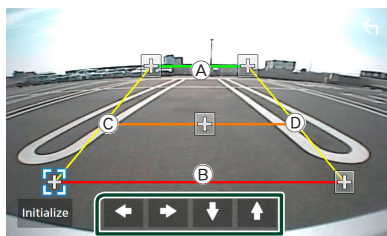

Make sure that lines (A) and (B) are horizontally parallel, and that lines (C) and (D) are of the same length.

NOTE

- Touch **Initialize** and then touch **Yes** to set all the  marks to their initial default position.

Use Dashboard Camera

A Dashboard Camera, DRV-N520 (optional accessory), connected to this unit lets you play video-recorded data and so on.

For details, see the instruction manual of the Dashboard Camera DRV-N520 (optional accessory).

NOTE

- To connect a dashboard camera, see **Connecting the camera (P.94)**.
- To use the dashboard camera function, it is necessary to set "Camera Assignment Settings" to "Dashboard Camera". (P.65)

Display the dashboard camera screen

- 1 Press the MENU button.**
 - Popup menu appears.

2 Touch Camera .

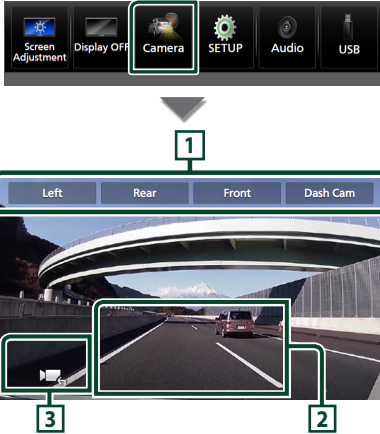

1 Camera Switching Keys

Touch to switch the view camera. It is necessary to set "Camera Assignment Settings" beforehand except "Rear". See **To set up the camera assignment settings** (P.65).

2 Camera off

Touch to exit the camera screen.

3 Key display

Touch to display the dashboard camera control keys.

External audio/video players (AV-IN)

- 1 Connect an external component to the VIDEO input terminal and the AV Audio input terminal. (P.92)
- 2 Select **AV-IN** as the source. (P.12)
- 3 Turn on the connected component and start playing the source.

NOTE

- To select the AV-IN source, it is necessary to set "AV-IN" to "None" in **Camera Assignment Settings**. (P.65)

HDMI source

- 1 Connect your smartphone to the HDMI input terminal. (P.93)
Use HDMI cable KCA-HD200 (optional accessory).
- 2 Select **HDMI** as the source. (P.12)
- 3 Start an application or playback on your smartphone.









Maestro Features Operation

By connecting this unit to the bus system of the vehicle using an iDatalink (commercially available), this unit can display vehicle information.

- 1 Press the **HOME** button.
➤ HOME screen appears.
- 2 Touch  on the HOME screen.

3 Touch icon.



	• Displays the control screen of the Bluetooth Hands-Free function provided for the vehicle.
	• Displays information about the tire pressures of the vehicle. *
	• Displays the control screen of the satellite radio source provided for the vehicle.
	• Displays the control screen of the media player source provided for the vehicle.
	• Displays the control screen of the Bluetooth streaming source provided for the vehicle.
	• Displays information about the Radar Detector. *
	• Displays information about the instruments such as a speedometer.
	• Displays information about the air conditioner of the vehicle. *
	• Displays information about the Parking Distance Sensor of the vehicle.

* These iDataLink features are displayed as the widget on the Home screen. **(P.11)** You can display the relevant screens by touching the widget.

NOTE

- Displayable screens, key names, and screen names vary depending on the type of the connected iDataLink and the model of the vehicle. For more details, access the following URL: www.idatalink.com/

Setup

Monitor Screen Setup

You can adjust the image quality of video, menu screen, etc.

1 Press the **MENU** button.

- Popup menu appears.

2 Touch **Screen Adjustment**.

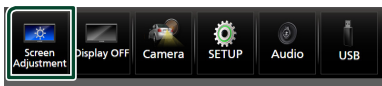

- Screen Adjustment screen appears.

3 Adjust each setting as follows.

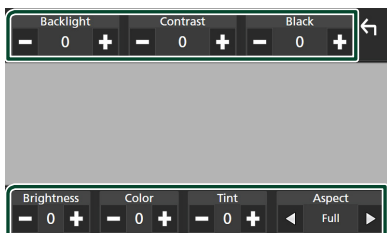

■ **Backlight/Contrast/Black/ Brightness/Color/Tint**

Adjust each setting.

■ **Aspect**

Select a screen mode.

Full: Changes the aspect ratio of video and displays video fully on the screen.

Normal: Displays video at the ratio of 4:3.

Auto: Displays video fully (vertically or horizontally) with no ratio change.

NOTE

- Settings to adjust vary depending on the current source.

System Setup

1 Press the **MENU** button.

- Popup menu appears.

2 Touch **SETUP**.

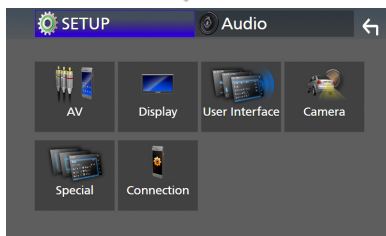
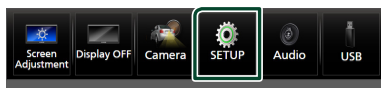

See the following section for each setting.

- Set up AV (**P.73**)
- Set up display (**P.71**)
- Set up the user interface (**P.70**)
- Set up camera (**P.64**)
- Set up special (**P.71**)
- Set up connection (**P.73**)

User Interface Setup

You can setup user interface parameters.

1 Press the **MENU** button.

➤ Popup menu appears.

2 Touch **SETUP**.

➤ SETUP screen appears.

3 Touch **User Interface**.

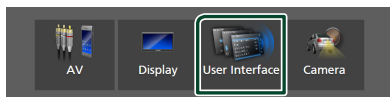

➤ User Interface screen appears.

4 Set each parameter as follows.

■ **Small Audio Text**

Change the text size for the source control screen.

ON : Change the text size smaller.

OFF (Default): Cancel.

■ **Beep**

Turn the key touch tone on or off.

Default is "ON".

■ **Widget SETUP**

Set up the widget displayed on the Home screen. (P.19)

■ **Parking Assist Display**

When the iDatalink (commercially available) is connected, you can display information about obstacles around the car.

ON: Always displays information.

Dyn. (Default): Displays information when the sensor detects obstacles.

OFF: Cancels this function.

This can be set when the iDatalink (commercially available) is connected.

■ **Parking Assist Position**

Select where to display information about obstacles on the screen (left or right).

"Left"/"Right" (Default)

This can be set when the iDatalink (commercially available) is connected.

■ **Language Select**

Select a language.

■ **Time Format**

■ **Clock**

■ **Time Zone**

■ **Clock Adjust**

You can set the date and time. See **Adjust the date and time manually (P.10)**.

Special Setup

You can setup special parameters.

1 Press the **MENU** button.

- Popup menu appears.

2 Touch **SETUP**.

- SETUP screen appears.

3 Touch **Special**.

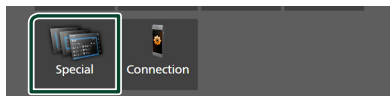

- Special screen appears.

4 Set each parameter as follows.

■ **DEMO**

Select the demonstration mode. Default is "ON".

■ **Software Information**

Confirm the software version of this unit.
(P.71)

■ **Open Source Licenses**

Display the open source licenses.

■ **Initialize**

Touch **Initialize** and then touch **Yes** to set all the settings to the initial default settings.

- Audio SETUP Memory is not initialized.

Software Information

You can confirm the software version of this unit.

1 Touch **Software Information** in the **Special** screen.

2 Confirm the software version.

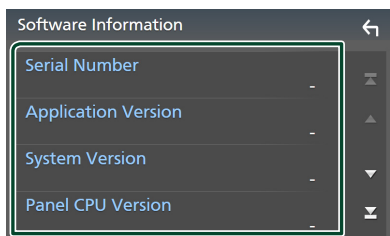

NOTE

- For how to update the software, see the relevant update procedure manual which comes with the software.

Display Setup

1 Press the **MENU** button.

- Popup menu appears.

2 Touch **SETUP**.

- SETUP screen appears.

3 Touch **Display**.

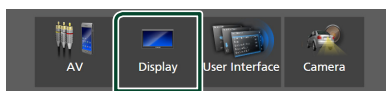

- Display screen appears.

4 Set each parameter as follows.

■ **Dimmer**

Select the dimmer mode.

OFF: Does not dim the display and keys.

ON: Dims the display and keys.

SYNC (Default): Turns the dimmer function on or off when the vehicle light control switch is turned on or off.

■ **OSD Clock**

Select if you want to display the clock while the screen is off, or while watching video files, etc.

■ **Key Color**

You can set the key illumination color.

(P.72)

■ **Wallpaper Customize**

You can change the wallpaper image or color. (P.72)

■ **Viewing Angle**

If it is hard to see the image on the screen evenly, adjust the viewing angle. The smaller the (negative) value, the more whitish the image on the screen looks.

"0" (Default)"/"-1"/"-2"/"-3"

Setup

■ Screen transition effect

Select whether to use the screen transition effect when the source control screen is switched to the Home screen.
"ON" (Default)/"OFF"

■ Customizing the key color

You can set the key illumination color.

- 1 Touch **Key Color** on the Display screen.
- 2 Touch the desired color.

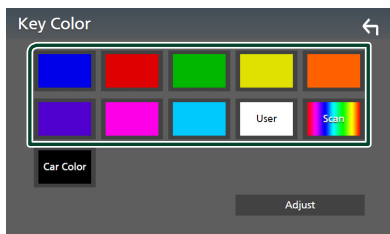

■ User

The color you have set in the process of **Adjust** is registered.

■ Scan

You can set the key color to continuously scan through the color spectrum.

■ Car Color

This can be selected when the iDatalink (commercially available) is connected.

- 3 Touch .

To register an original color

You can register your original color.

- 1 Touch **User** on the Key Color screen.
- 2 Touch **Adjust**.
- 3 Use **-** and **+** to adjust each color value.

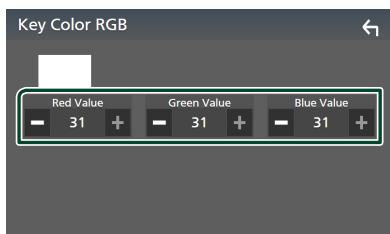

- 4 Touch .

■ Change the wallpaper image or color

- 1 Touch **Wallpaper Customize** on the Display screen.
- 2 Select an image.

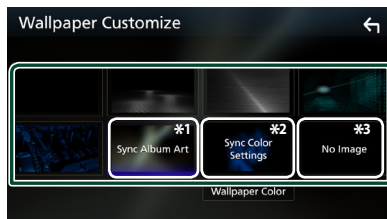

*1 The album art currently being displayed is used as a wallpaper.

*2 Select a wallpaper color in advance.

*3 Select an original image in advance.

To select wallpaper color

- 1 Touch **Wallpaper Color** on the Wallpaper Customize screen.
- 2 Select a wallpaper color.

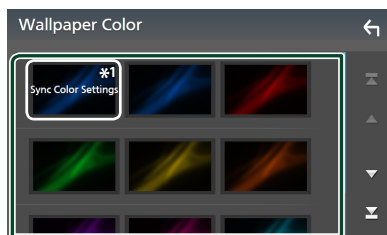

*1 The color you have selected at **Key Color** is added on the image. If you select "Scan" at **Key Color**, you cannot select this image.

- 3 Touch .

To register an original image

With "KENWOOD Portal APP" application installed on your iPhone or Android smartphone, you can upload image files to this unit and set an image as the wallpaper image. See **Importing Image Files (P.19)**.

AV Setup

You can set AV parameters.

- 1 Press the **MENU** button.
 - Popup menu appears.
- 2 Touch **SETUP**.
 - SETUP screen appears.
- 3 Touch **AV**.

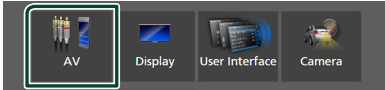

➤ AV screen appears.

- 4 Set each parameter as follows.

■ Guidance/Voice Recognition Volume

Adjust the volume of the guidance and voice recognition in Apple CarPlay/Android Auto mode. Default is "19".

■ Incoming Call Volume (Ring)

Adjust the ring tone volume in Apple CarPlay/Android Auto mode. Default is "15".

■ In Call Volume (Talking)

Adjust the dial tone volume and the volume during a call in Apple CarPlay/Android Auto mode. Default is "15".

■ Speech Quality Adjust

Adjust the speech quality.

Microphone Level : Adjust the level of microphone gain. Default is "0".

Echo Cancel Level : Adjust the level of echo cancellation. Default is "0".

Noise Reduction Level : Reduce the noise generated in the surrounding environment without changing the microphone volume. Use this function when the voice of caller is not clear. Default is "0".

■ iPod Bluetooth Connection

See **Select the method of making connections for outputting sound from the iPod source (P.29)**.

■ Driving Position

Select the driving position (left or right).
"Left" (Default)/"Right"

■ Reverse with ATT

Select whether to decrease the audio volume automatically when the gear is shifted to the reverse (R) position. Default is "ON".

■ Maestro SETUP

Confirm the information about or change the settings for using the iDataLink (commercially available).

■ Vehicle Features

This function requires a commercial adaptor. Consult your KENWOOD dealer for details.

Connection Setup

NOTE

- Some items in the Connection Setup are disabled while using Apple CarPlay.

- 1 Press the **MENU** button.
 - Popup menu appears.
- 2 Touch **SETUP**.
 - SETUP Menu screen appears.
- 3 Touch **Connection**.

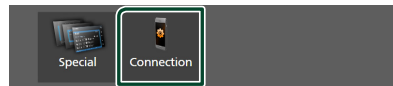

➤ Connection Setup screen appears.

- 4 Set each parameter as follows.

■ Bluetooth

Turns the Bluetooth function on or off.

■ Device List

Select the connected device to be used.
(P.53)

■ Device Name

If you select ON for Bluetooth, you can change the Bluetooth device name.

See **Change the device name for Bluetooth (P.74)**.

■ PIN Code

You can change the PIN Code. See **Change the PIN Code (P.74)**.

■ Device Address

Display the Bluetooth device address.

Setup

■ TEL SETUP

You can change the settings for Hands-Free function. See **Hands-Free Setup (P.63)**.

■ Wi-Fi SETUP

You can change the device name for Wireless Mirroring and display the device address, password. See **Change the device name for Wireless Mirroring (P.74)**.

■ Android Auto Auto Launch

Select whether to display the Android Auto screen automatically. Default is "ON".

■ Reset Android Auto Wireless Connection

You can reset the password for wireless Android Auto.

The system of the unit is rebooted after selecting **Yes**.

■ Change the device name for Bluetooth

- 1 Touch **Device Name** on the Connection Setup screen.
➤ Change Device Name screen appears.
- 2 Touch and hold **BS**.
- 3 Input the device name.



- 4 Touch **Enter**.

■ Change the PIN Code

- 1 Touch **PIN Code** on the Connection Setup screen.
➤ Change PIN Code screen appears.
- 2 Touch and hold **BS**.
- 3 Input the PIN Code.

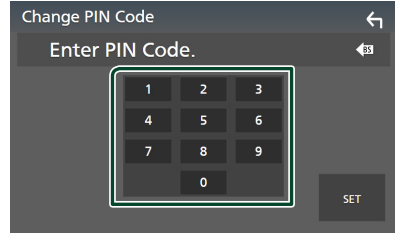

- 4 Touch **SET**.

■ Change the device name for Wireless Mirroring

- 1 Touch **Wi-Fi SETUP** on the Connection Setup screen.
➤ Change Device Name screen appears.
- 2 Touch **Device Name**.
- 3 Touch and hold **BS**.
- 4 Input the device name.



- 5 Touch **Enter**.

Controlling Audio

You can adjust various settings such as audio balance or subwoofer level.

- 1 Press the **MENU** button.
 - Popup menu appears.
- 2 Touch **Audio**.

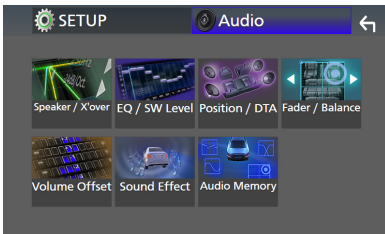
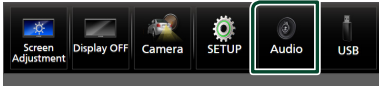

See the following section for each setting.

- Set up Speaker / X'over (**P.76**)
- Controlling EQ / SW Level (**P.78**)
- Set Position / DTA (**P.81**)
- Controlling Fader / Balance (**P.78**)
- Set Volume Offset (**P.79**)
- Set Sound Effect (**P.80**)
- Use Audio Memory (**P.82**)

3-way speaker system setup (DMX958XR / DMX908S)

Select the appropriate crossover network mode for the speaker system used (2-way or 3-way speaker system).

⚠ CAUTION

- Connecting 3-way speakers with the 2-way mode selected can break the speakers.

- 1 Press the **HOME** button.
 - HOME screen appears.
- 2 Touch .
- 3 Touch **STANDBY**.
- 4 Press the button ① followed by the button ② for 1 second at the same time.



- Speaker system select screen appears.

- 5 Select the crossover network mode.

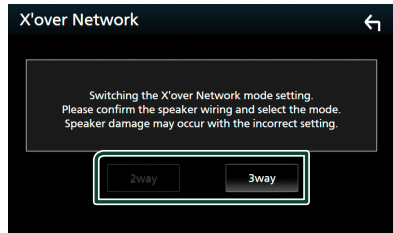

- A confirmation screen appears.

6 Touch Yes.

NOTE

- When the 3-way speaker system is selected, the following functions are disabled.
 - Front focus of Listening Position / DTA
 - Fader for Controlling General Audio
 - Selection of the speakers to output sound from the smartphone/cell-phone of Bluetooth HF/Audio
 - Beep for User Interface Setup
- While talking on the paired phone or using the voice recognition function, the speaker system cannot be switched.

Speaker / X'over setup

- 1 Press the **MENU** button.
 - Popup menu appears.
- 2 Touch **Audio**.
 - Audio screen appears.
- 3 Touch **Speaker / X'over**.



4 Select a car type.

You can select the car type and speaker network, etc.

When you select your car type, the Delay Time Alignment is activated automatically (for timing adjustment of sound output for each channel) to have the highest surround effects.



5 Touch the speaker (1) you wish to adjust and set each parameter (2) as follows.

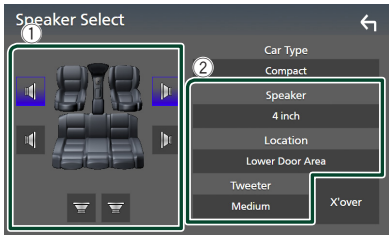

■ **Speaker**

You can select a speaker type and its size to get the best sound effects.

When the speaker type and size are selected, the speaker crossover network is set automatically.

■ **Location (Only for Front, Rear)**

Select the speaker position you have installed.

■ **Tweeter (Only for Front)**

You can set up the tweeter when you are selecting front speakers.

None, Small, Medium, Large

■ **X'over**

Display the speaker crossover setup screen.

You can adjust the crossover frequency that was set automatically when you selected the speaker type.

For details, see **Crossover network setup (P.76)**

When Speaker network is set to 3-way:

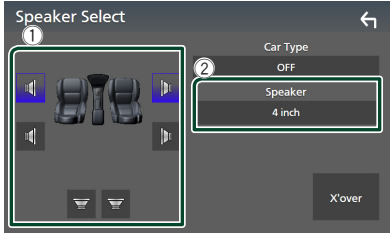

NOTE

- For how to switch to the 3-way speaker system, see **3-way speaker system setup (P.75)**. Connecting 3-way speakers with the 2-way mode selected can break the speakers.
- Select "None" if you have no speakers.

■ **Crossover network setup**

You can set the crossover frequency of speakers.

1 Touch **X'over**.

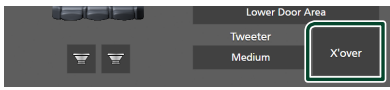

2 Touch the speaker to set up.



3 Set each parameter as follows.

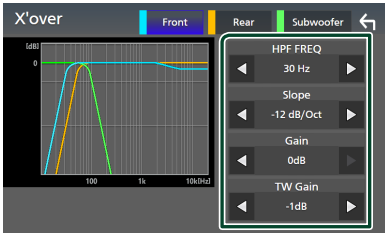

■ HPF FREQ

High Pass Filter adjustment. (When Front or Rear is selected on the Speaker Select screen)

■ LPF FREQ

Low Pass Filter adjustment. (When Subwoofer is selected on the Speaker Select screen)

■ Slope *1

Set a crossover slope.

■ Gain

Adjust the gain of the front speaker, rear speaker, or subwoofer.

■ TW Gain *2

Adjust the tweeter level. (When Front is selected on the Speaker Select screen)

■ Phase Inversion *3

Set the phase of subwoofer output.
Check **Phase Inversion** to shift the phase 180 degrees. (When Subwoofer is selected on the Speaker Select screen)

*1 Only when "LPF FREQ"/"HPF FREQ" is set to a mode other than "Through" in **X'over**.

*2 Only when "Tweeter" is set to "Small", "Medium", "Large" in **Speaker Setup**.

*3 Only when "Subwoofer" is set to a mode other than "None" in **Speaker Setup**.

When Speaker network is set to 3-way:

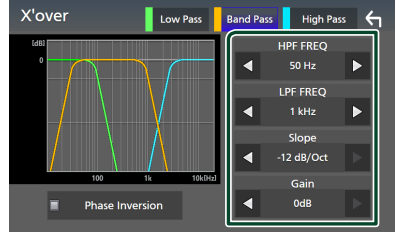

■ FREQ (High Pass)

High Pass Filter adjustment.

■ HPF FREQ, LPF FREQ (Band Pass)

Band Pass Filter adjustment. (When Mid Range Speaker is selected on the Speaker Select screen)

■ FREQ (Low Pass)

Low Pass Filter adjustment. (When Woofer is selected on the Speaker Select screen)

■ Slope *1 *2

Set a crossover slope.

■ Gain

Set the gain of each speaker.

■ Phase Inversion

Set the phase of tweeter, mid range, and woofer output.

Check **Phase Inversion** to shift the phase 180 degrees.

*1 Only when "LPF FREQ"/"HPF FREQ" (Band Pass) is set to a mode other than "Through" in **X'over**.

*2 Only when "FREQ" (Low Pass) is set to a mode other than "Through" in **X'over**.

NOTE

- For how to switch to the 3-way speaker system, see **3-way speaker system setup (P.75)**. Connecting 3-way speakers with the 2-way mode selected can break the speakers.

Controlling General Audio

- 1 Press the **MENU** button.
 - Popup menu appears.
- 2 Touch **Audio**.
 - Audio screen appears.
- 3 Touch **Fader / Balance**.

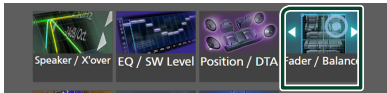

- 4 Set each parameter as follows.

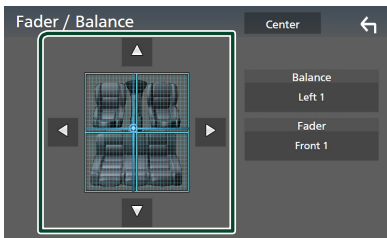

■ Fader / Balance

Adjust the volume balance around the touched area.

◀ and ▶ adjust the right and left volume balance.

▲ and ▼ adjust the front and rear volume balance.

■ Center

Clear the adjustment.

NOTE

- When the 3-way speaker system is selected, "Fader" adjustment is disabled.

Equalizer Control

You can adjust equalizer by selecting the optimized setting for each category.

- 1 Press the **MENU** button.
 - Popup menu appears.
- 2 Touch **Audio**.
 - Audio screen appears.
- 3 Touch **EQ / SW Level**.



- 4 Touch the screen and set the **Graphic Equalizer** as desired.

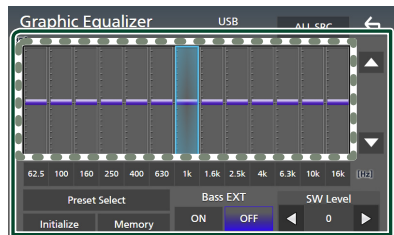

■ Gain level (area in dotted frame)

Adjust the gain level by touching each frequency bar.

You can select a frequency bar and adjust its level by ▲, ▼.

■ Preset Select

Display the screen for selecting the preset equalizer curve. (P.79)

■ Memory

Saves the adjusted equalizer curve as "User1" to "User4". (P.79)

■ Initialize

Initialize (flatten) the current EQ curve.

■ ALL SRC

Apply the adjusted equalizer curve to all sources. Touch **ALL SRC** and then touch **OK** on the confirmation screen.

■ Bass EXT (Bass Extend Settings)

When turned on, the frequencies lower than 62.5 Hz is set to the same gain level (62.5 Hz).

■ SW Level

Adjust the subwoofer volume. This setting is not available when Subwoofer is set to "None". See **Speaker / X'over setup (P.76)**.

📄 Recall the EQ curve

- 1 Touch **Preset Select**.
- 2 Select an EQ curve.

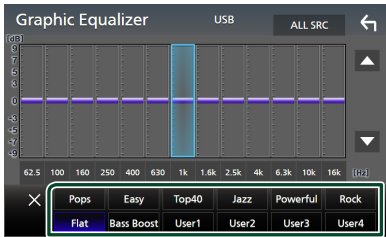

📄 Save the EQ curve

- 1 Adjust the EQ curve.
- 2 Touch **Memory**.
- 3 Select where to save.

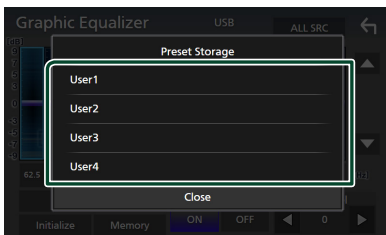

Volume Offset

Finely adjust the volume of the current source to minimize the difference in volume between different sources.

- 1 Press the **MENU** button.
 - Popup menu appears.
- 2 Touch **Audio**.
 - Audio screen appears.
- 3 Touch **Volume Offset**.

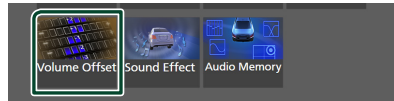

- 4 Touch **+ or -** to adjust the level.

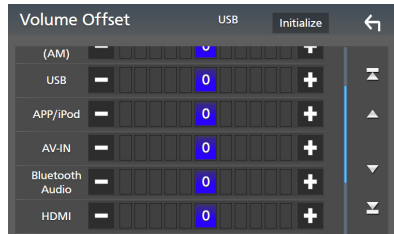

■ Initialize

Returns to the initial settings.

Touch **Initialize** and then touch **Yes** on the confirmation screen.

NOTE

- If you have increased the volume first, then reduce the volume using "Volume Offset". Switching the current source to another source suddenly may output extremely loud sound.

Sound Effect

You can set sound effects.

1 Press the **MENU** button.

➤ Popup menu appears.

2 Touch **Audio**.

➤ Audio screen appears.

3 Touch **Sound Effect**.



4 Set each parameter as follows.

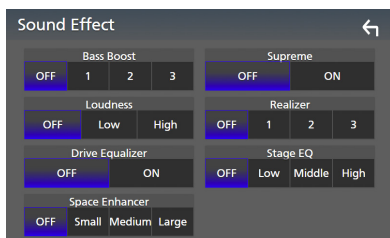

■ **Bass Boost**

Set the amount of bass boost "OFF"/"1"/"2"/"3".

■ **Loudness**

Set the amount of boost of low and high tones.

"OFF", "Low", "High"

■ **Drive Equalizer**

Reduces the driving noise by raising the bandwidth.

"OFF", "ON"

■ **Space Enhancer**

Select the feeling of sound space enhancement.

"OFF"/"Small"/"Medium"/"Large".

This setting is not available for the HD Radio tuner source.

■ **Supreme**

Turn ON/OFF the Supreme function.

Technology to extrapolate and supplement with proprietary algorithm, the high-frequency range that is cut off when encoding.

■ **Realizer**

Virtually make the sound more realistic using the Digital Signal Processor (DSP) system.

Select the level from "OFF"/"1"/"2"/"3".

■ **Stage EQ**

You can adjust the height of speakers virtually to suit your listening position.

"OFF"/"Low"/"Middle"/"High".

Listening Position / DTA

Listening Position / DTA allows you to improve the sound field depending on the position of the seat you sit.

Listening Position / DTA allows you to set "Listening Position" and "Front Focus". You cannot set both at the same time.

- 1 Press the **MENU** button.
 - Pop up menu appears.
- 2 Touch **Audio**.
 - Audio screen appears.
- 3 Touch **Position / DTA**.



- Set up Listening Position (**P.81**)
- Set up Front Focus (**P.81**)

Listening Position

Adjust the sound delay time so that the sounds from different speakers arrive at the listener sitting on the selected seat at the same time.

- 1 Touch **Listening Position** on the Position / DTA screen.
- 2 Select a listening position from **Front R** (Right front), **Front L** (Left front), **Front All** (All front), and **All**.

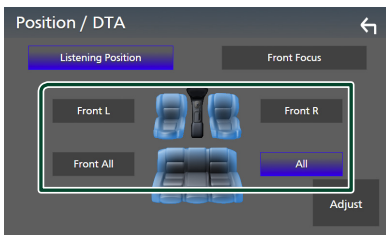

Position DTA control

You can fine-adjust your listening position.

- 1 Touch **Adjust**.
- 2 Touch **Delay**.

- 3 Touch **◀** or **▶** to adjust the delay time of the selected speaker.



- 4 Touch **Level**.

- 5 Touch **◀** or **▶** to adjust the sound level of the selected speaker.



NOTE

- To initialize the Delay and Level settings, touch **Initialize** and **Yes** on the confirmation screen.

Front Focus

You can focus the imaginary sound image on the front of the selected seat.

- 1 Touch **Front Focus** on the Position / DTA screen.
- 2 Select a front focus position. For **Front All** and **All**, select Priority L or R depending on which side you want to put the imaginary sound image.

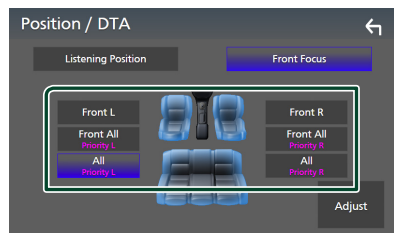

Controlling Audio

NOTE

- When the 3-way speaker system is selected, front focus feature is disabled.

Front Focus fine adjustment

- 1 Touch **Adjust**.
- 2 Touch **Delay**.
- 3 Set each parameter as follows.

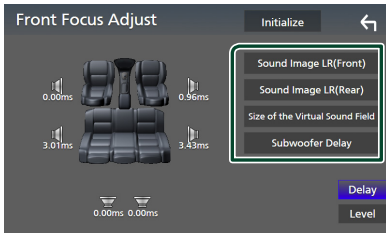

■ Sound Image LR (Front)

Focus the sound image on the front of front seats.

■ Sound Image LR (Rear)

Focus the sound image on the front of rear seats.

■ Size of the Virtual Sound Field

Adjust the size of sound image to meet your taste. If the sound image is shifted from the front, move it back by **Sound Image LR (Front)** or **Sound Image LR (Rear)**.

■ Subwoofer Delay

Adjust the delay time of subwoofer sound.

- 4 Touch **Level**.

- 5 Touch ◀ or ▶ to adjust the sound level of the selected speaker.



NOTE

- To initialize the Delay and Level settings, touch **Initialize** and **Yes** on the confirmation screen.

Audio Setup memory

Audio Control settings can be memorized. The memorized settings can be recalled at any time.

- 1 Press the **MENU** button.
▶ Pop up menu appears.
- 2 Touch **Audio**.
▶ Audio screen appears.
- 3 Touch **Audio Memory**.



■ SETUP Memory

Lock or unlock the Audio SETUP Memory/Recall/Clear.

■ Audio SETUP Memory

Memorize the current audio settings.

- Fader / Balance, Speaker / X'over, Equalizer (User Preset, SW Level), Position / DTA, Sound Effect (**P.75**)

■ Audio SETUP Recall

Recall the memorized audio setting.

■ Audio SETUP Clear

Clear the Audio SETUP Memory and the currently memorized audio settings.

If the iDataLink (commercially available) is connected, the audio settings revert to the values set by the iDataLink.

Remote control

This unit can be operated using the remote control KCA-RCDV340 (optional accessory).

⚠ CAUTION

- Put the remote control in a place where it will not move during braking or other operations. A dangerous situation could result, if the remote control falls down and gets wedged under the pedals while driving.
- Risk of fire or explosion if the battery is replaced by an incorrect type. Ensure to replace only with the same type.
- Risk of fire, explosion or the leakage of flammable liquid or gas if the battery is left in an extremely high temperature surrounding environment and/or subjected extremely low air pressure. The battery pack or batteries shall not be exposed to excessive heat such as sunshine, fire or the like.
- Risk of fire, explosion or the leakage of flammable liquid or gas if the battery is disposed into fire or a hot oven, recharged, shorted, mechanically crushed or cut of the battery.
- If spilled fluid comes in contact with your eyes or on clothing, immediately rinse with water and consult a physician.

Battery Installation

If the remote control operates only over shorter distances or does not operate at all, it is possible that the batteries are depleted. In such instances, replace the both batteries with new ones.

- 1 Insert two "AAA"/"R03"-size batteries with the ⊕ and ⊖ poles aligned properly, following the illustration inside the case.

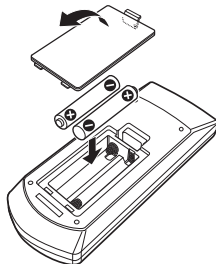

Functions of the Remote control Buttons

■ Switch the operation mode

The functions operated from the remote control differ depending on the position of the mode switch.

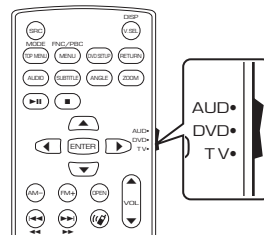

■ AUD mode

Switch to this mode when controlling a selected source or tuner source, etc.

■ DVD mode/TV mode

Not used.

NOTE

- When controlling a player that is not integrated in the unit, select "AUD" mode.

■ Direct search mode

Using the remote control, you can jump directly to the desired frequency value of the Radio source by entering the number corresponding to the content.

NOTE

- This operation cannot be performed for the USB device and iPod.

- 1 Press the **DIRECT** button several times until the desired content appears.

The available contents are different depending on the source type.

Remote control

■ Radio (DMX9708S)

Frequency value

■ HD Radio tuner (DMX958XR / DMX908S)

Frequency value/Channel number

■ SiriusXM

Channel number

2 Enter the number of the content you want to play using the numeric keypad.

3 Press the ◀◀ or ▶▶ button.

➤ The content corresponding to the number you entered is played.

■ Basic Operation

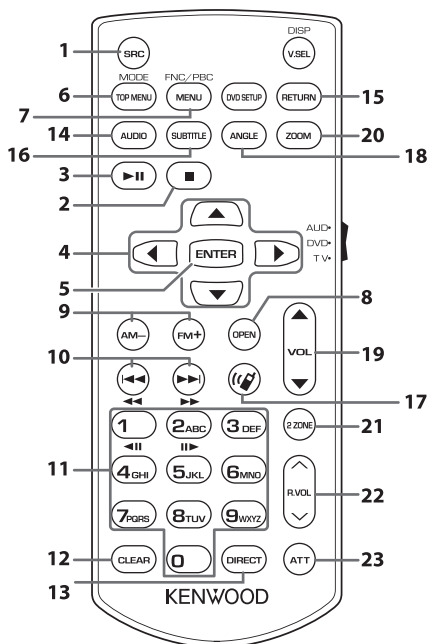

	Key Name	Mode switch	Function
1	SRC	–	Switches to the source to be played. In Hands-Free mode, hangs up the phone.
2	■	–	Not used.
3	▶▶	–	Pauses the track or file, and resumes playing by pressing twice. For the Radio (DMX9708S only) and HD Radio (DMX958XR / DMX908S only) sources in AUD mode, switches the seek mode. Not used for the SiriusXM source.
4	▲/▼/◀/▶	–	Not used.
5	ENTER	–	Performs the selected function.
6	TOP MENU	AUD	Screen mode changes each time you press this key during video playback.
7	MENU	AUD	Displays the control screen of current source. (USB)
8	OPEN	–	Not used.

	Key Name	Mode switch	Function
9	AM-/FM+	AUD	Selects the folder to be played. For the Radio (DMX9708S only) and HD Radio (DMX958XR / DMX908S only) sources in AUD mode, selects FM/AM band to be received. For the SiriusXM source in AUD mode, selects the band to be received.
10	◀◀/▶▶	–	Selects the track or file to be played. For the Radio (DMX9708S only) and HD Radio (DMX958XR / DMX908S only), and SiriusXM sources in AUD mode, switches to broadcast stations received by the unit.
11	Numeric Keypad	AUD	Allows you to enter the number to search in the direct search mode. For details on the direct search mode, see Direct search mode (P.83) . For the Radio (DMX9708S only) and HD Radio (DMX958XR / DMX908S only), and SiriusXM sources, allows you to enter the preset number. <ul style="list-style-type: none"> • If the preset number is one digit, press the number. • If the preset numbers is two digits, press continuously the numbers within 3 seconds. • Pressing ◀▶ within 3 seconds allows you to determine the preset number of one digit.
12	CLEAR	–	Not used.
13	DIRECT	–	Switches to the direct search mode. (P.83) .
14	AUDIO	–	Not used.
15	RETURN	–	Not used.
16	SUBTITLE	–	Not used.
17		–	When a call comes in, answers the call.
18	ANGLE	–	Not used.
19	VOL ▲▼	–	Adjusts the volume.
20	ZOOM	–	Not used.
21	2 ZONE	–	Not used.
22	R.VOL ^v	–	Not used.
23	ATT	–	Lowers the volume by pressing the key once. Restores the previous volume by pressing the key twice.

Connection/Installation

This section is for the professional installer. For safety's sake, leave wiring and mounting to professionals. Consult the car audio dealer.

Before Installation

Before installation of this unit, please note the following precautions.

▲ WARNINGS

- If you connect the ignition wire (red) and the battery wire (yellow) to the car chassis (ground), you may cause a short circuit, that in turn may start a fire. Always connect those wires to the power source running through the fuse box.
- Do not cut out the fuse from the ignition wire (red) and the battery wire (yellow). The power supply must be connected to the wires via the fuse.

▲ CAUTION

- Install this unit in the console of your vehicle. Do not touch the metal part of this unit during and shortly after the use of the unit. Metal part such as the heat sink and enclosure become hot.

NOTE

- Mounting and wiring this product requires skills and experience. For best safety, leave the mounting and wiring work to professionals.
- Make sure to ground the unit to a negative 12V DC power supply.
- Do not install the unit in a spot exposed to direct sunlight or excessive heat or humidity. Also avoid places with too much dust or the possibility of water splashing.
- Do not use your own screws. Use only the screws provided. If you use the wrong screws, you could damage the unit.
- If the power is not turned ON ("There is an error in the speaker wiring. Please check the connections." is displayed), the speaker wire may have a short-circuit or touched the chassis of the vehicle and the protection function may have been activated. Therefore, the speaker wire should be checked.

- If your car's ignition does not have an ACC position, connect the ignition wires to a power source that can be turned on and off with the ignition key. If you connect the ignition wire to a power source with a constant voltage supply, such as with battery wires, the battery may be drained.
- If the console has a lid, make sure to install the unit so that the front panel will not hit the lid when closing and opening.
- If the fuse blows, first make sure the wires are not touching to cause a short circuit, then replace the old fuse with one with the same rating.
- Insulate unconnected wires with vinyl tape or other similar material. To prevent a short circuit, do not remove the caps on the ends of the unconnected wires or the terminals.
- Connect the speaker wires correctly to the terminals to which they correspond. The unit may be damaged or fail to work if you share the ⊖ wires or ground them to any metal part in the car.
- When only two speakers are being connected to the system, connect the connectors either to both the front output terminals or to both the rear output terminals (do not mix front and rear). For example, if you connect the ⊕ connector of the left speaker to a front output terminal, do not connect the ⊖ connector to a rear output terminal.
- After the unit is installed, check whether the brake lamps, blinkers, wipers, etc. on the car are working properly.
- This unit has the cooling fan to decrease the internal temperature. Do not mount the unit in a place where the cooling fan of the unit is blocked. Blocking these openings will inhibit the cooling of the internal temperature and result in malfunction.

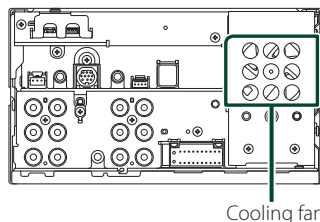

- Mount the unit so that the mounting angle is 30° or less.
- Do not connect anything to the terminal printed with "NC". "NC" means "Non Connection" or "No Connecting". If other signals are supplied to the terminal, the unit may not work properly.
- Do not press hard on the panel surface when installing the unit to the vehicle. Otherwise scars, damage, or failure may result.
- Reception may drop if there are metal objects near the Bluetooth/Wi-Fi antenna.

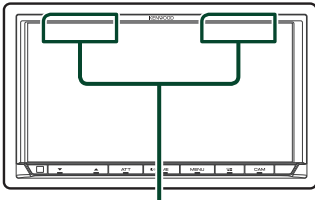

Bluetooth/Wi-Fi antenna unit

Supplied accessories for installation

①		x1
②	(1 m)	x1
③		x1
④	(3 m)	x1
⑤		x2
⑥	(M5 x 8 mm)	x6

⑦	(M5 x 8 mm)	x6
⑧		x1
⑨	(3.5 m)	x1
⑩		x1

Installation procedure

- 1) To prevent a short circuit, remove the key from the ignition and disconnect the ⊖ terminal of the battery.
- 2) Make the proper input and output wire connections for each unit.
- 3) Connect the speaker wires of the wiring harness.
- 4) Connect the wiring harness wires in the following order; ground, battery, ignition.
- 5) Connect the wiring harness connector to the unit.
- 6) Install the unit in your car.
- 7) Reconnect the ⊖ terminal of the battery.
- 8) Perform the Initial Setup.
See **Initial SETUP (P.8)**.

Installing the unit

Non-Japanese cars

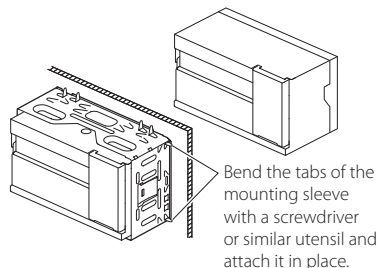

Japanese cars

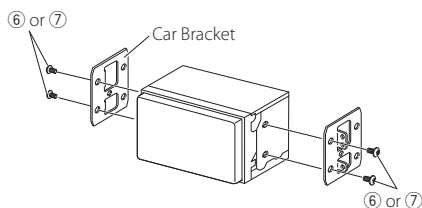

NOTE

- Make sure that the unit is installed securely in place. If the unit is unstable, it may malfunction (eg, the sound may skip).

Trim plate

- 1) Attach accessory ⑧ to the unit.

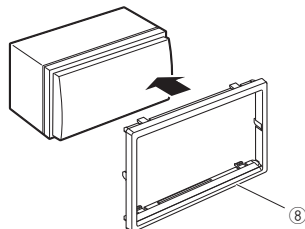

GPS antenna

GPS antenna is installed inside of the car. It should be installed as horizontally as possible to allow easy reception of the GPS satellite signals.

To mount the GPS antenna inside your vehicle:

- 1) Clean your dashboard or other surface.
- 2) Remove the separator of the metal plate (accessory ⑩).
- 3) Press the metal plate (accessory ⑩) down firmly on your dashboard or other mounting surface. You can bend the metal plate (accessory ⑩) to conform to a curved surface, if necessary.
- 4) Remove the separator of the GPS antenna (accessory ⑨), and stick the antenna to the metal plate (accessory ⑩).

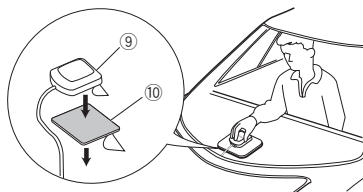

NOTE

- Use the supplied GPS antenna. Using the GPS antenna other than the supplied one may cause a drop in positioning accuracy.
- Depending on the type of car, reception of the GPS satellite signals might not be possible with an inside installation.
- Please install this GPS antenna in an area away from any antennas that are used with CB radios or satellite televisions.
- The GPS antenna should be installed at a position that is spaced at least 12 inch (30 cm) from smartphone/cell-phone or other transmitting antennas. Signals from the GPS satellite may be interfered with by these types of communication.
- Painting the GPS antenna with (metallic) paint may cause a drop in performance.

Microphone unit

- 1) Check the installation position of the microphone (accessory ④).
- 2) Clean the installation surface.
- 3) Remove the separator of the microphone (accessory ④), and stick the microphone to the place shown below.
- 4) Wire the microphone cable up to the unit with it secured at several positions using tape or other desired method.
- 5) Adjust the direction of the microphone (accessory ④) to the driver.

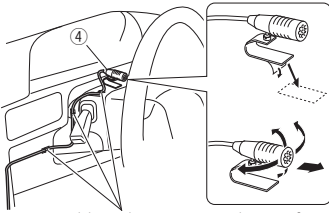

Fix a cable with a commercial item of tape.

Removing the trim plate

- 1) Engage the catch pins on the extraction key (accessory ⑤) and remove the two locks on the lower level.
Lower the trim plate (accessory ⑧) and pull it forward as shown in the figure.

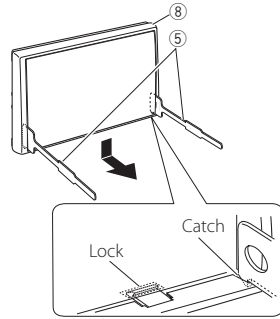

NOTE

- The trim plate can be removed from the top side in the same manner.

- 2) When the lower level is removed, remove the upper two locations.

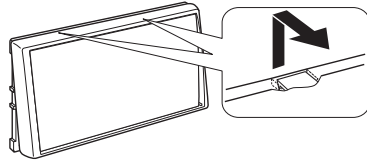

■ Removing the unit

- 1) Remove the trim plate. **(P.89)**
- 2) Insert the two extraction key (accessory ⑤) deeply into the slots on each side, as shown.

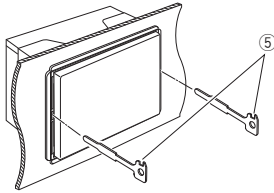

- 3) Lower the extraction key toward the bottom, and pull out the unit halfway while pressing towards the inside.

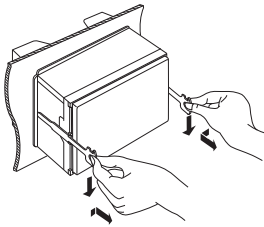

NOTE

- Be careful to avoid injury from the catch pins on the extraction key.

- 4) Pull the unit all the way out with your hands, being careful not to drop it.

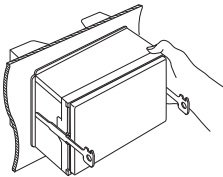

Connecting wires to terminals

Other cable : Not used.

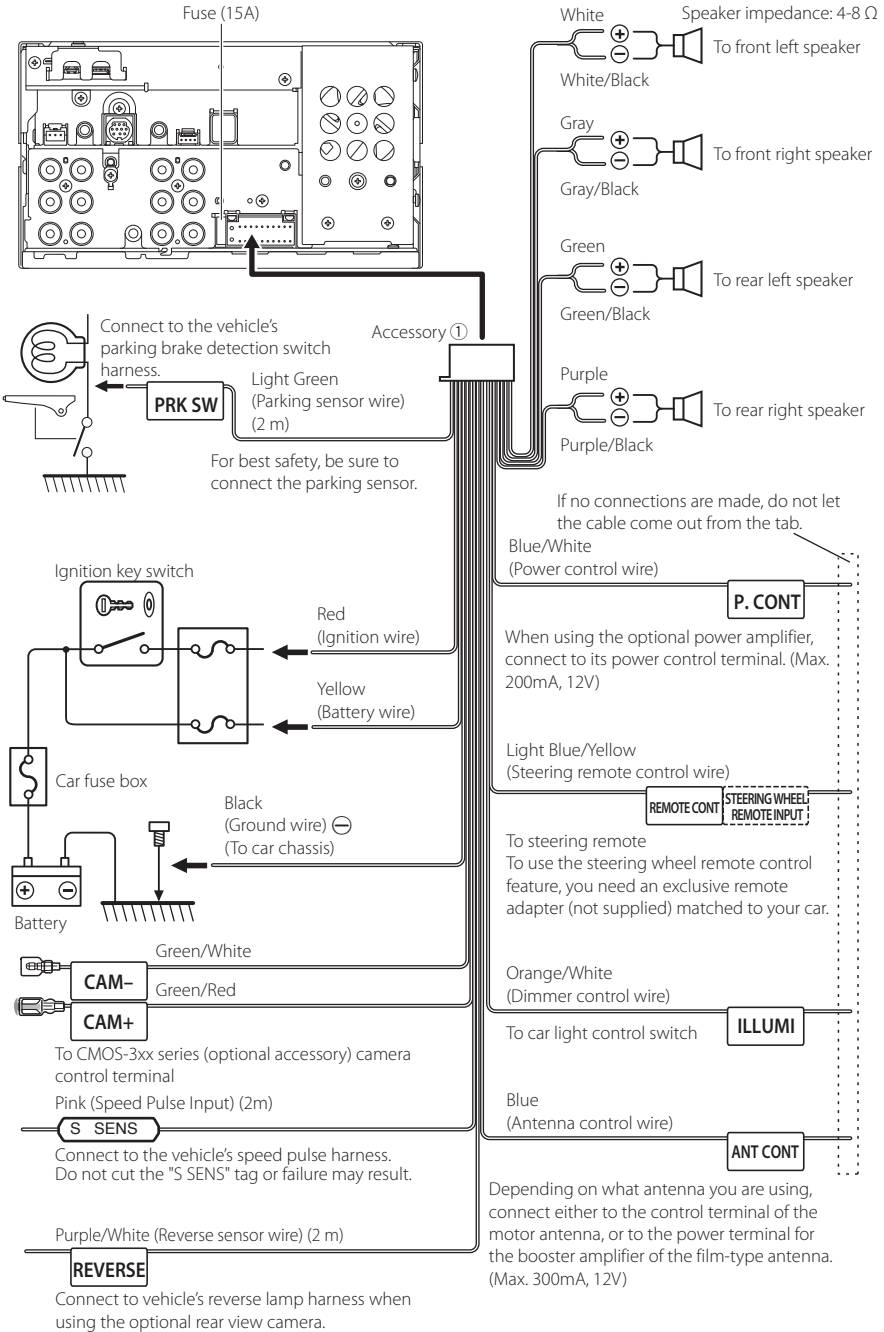

3-way speaker system setup

DMX958XR / DMX908S

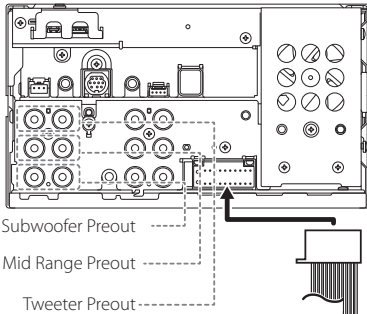

When connecting to an external amplifier, connect its ground wire to the car's chassis to avoid damaging the unit.

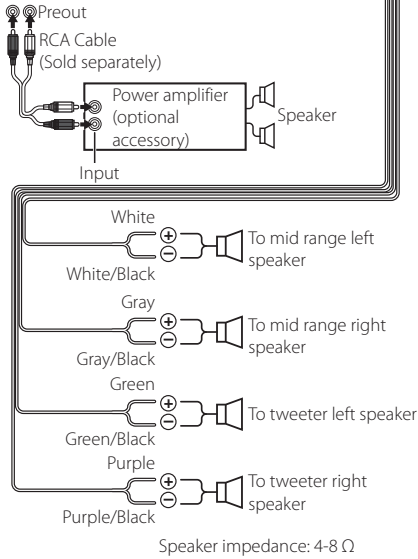

NOTE

- For speaker system setup, see **3-way speaker system setup (P.75)**.
- For speaker setup and crossover setup, see **Speaker / X'over setup (P.76)**.
- For how to connect speaker wires to terminals other than speaker terminals and Preout terminals, see **Connecting the system and external components (P.92)** and **Connecting wires to terminals (P.91)**.

Connecting the system and external components

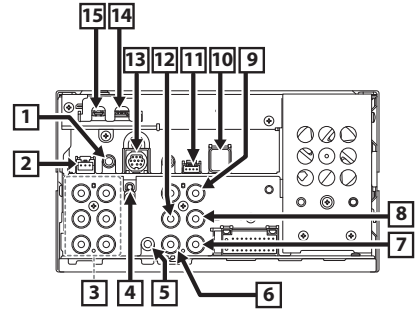

- Accessory ④: Microphone
- Dashboard camera interface
Connect a Dashboard Camera DRV-N520 (optional accessory). (P.94)
- When connecting to an external amplifier, connect its ground wire to the car's chassis to avoid damaging the unit.
- FM/AM antenna input
- AV-IN (for audio) input (ø3.5 mini jack)
- VIDEO Input (Yellow)
Connect a RCA cable (sold separately) to VIDEO input terminal to use AV-IN (for visual) or Side (Left or Right) view camera Input (Yellow).
For more information, see **To set up the camera assignment settings (P.65)**.
- Front view camera/Dashboard camera input (Yellow). *1
See **To set up the camera assignment settings (P.65)**.
- Rear view camera input (Yellow) *2
- 3rd view camera input (Yellow). See **To set up the camera assignment settings (P.65)**.

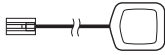
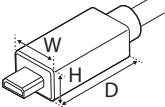
<p>10</p>	<p>Accessory ②: GPS Antenna Use the supplied GPS antenna. Using the GPS antenna other than the supplied one may cause a drop in positioning accuracy.</p> 
<p>11</p>	<p>iDatalink connector</p>
<p>12</p>	<p>VIDEO Output (Yellow)</p>
<p>13</p>	<p>SiriusXM Connect Vehicle Tuner connector For more information on how to install the SiriusXM Connect Vehicle tuner, consult the installation guide included with the tuner.</p>
<p>14</p>	<p>USB terminal (USB Type-C*)</p>
<p>15</p>	<p>HDMI input (Type-D) Connect a KCA-HD200 (optional accessory) to HDMI input terminal.</p>  <p>W: 11.1 mm or less H: 7.7 mm or less D: 21.5 mm or less</p>

*1 Connect an HD camera to Front view camera/ Dashboard camera input terminal to use HD video. (DMX958XR only)

*2 Connect an HD camera to Rear view camera input terminal to use HD video. (DMX958XR only)

Installation/removal of fixing bracket

When you connect the cable to HDMI terminal and USB terminal, remove the fixture. After connecting the cable, put the fixture again.

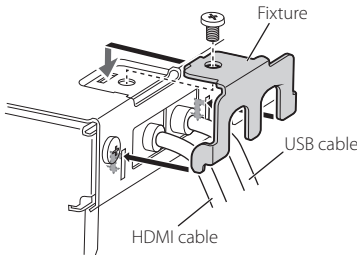

Connecting a USB device

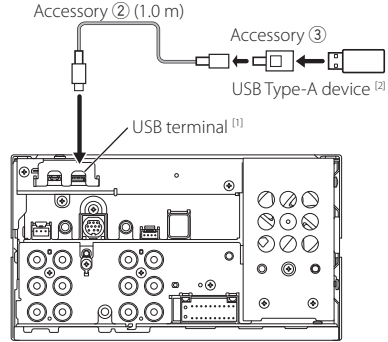

^[1] USB maximum power supply current :
DC 5 V $\overline{\text{---}}$ 3.0 A

^[2] Sold separately

Connecting an iPod/iPhone

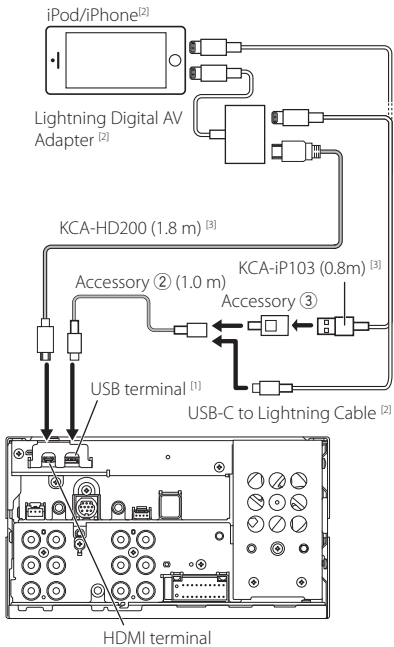

^[1] USB maximum power supply current :
DC 5 V $\overline{\text{---}}$ 3.0 A

^[2] Sold separately

^[3] Optional accessory

Connecting an Android smartphone

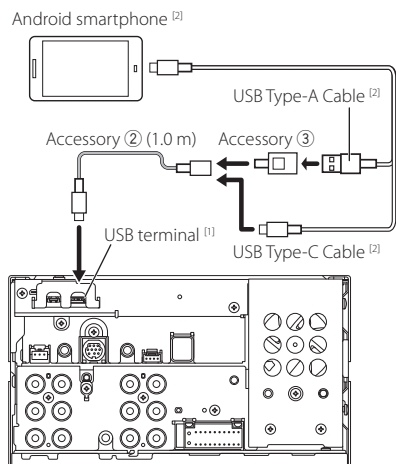

^[1] USB maximum power supply current :
DC 5 V $\overline{\text{---}}$ 3.0 A

^[2] Sold separately

Connecting the camera

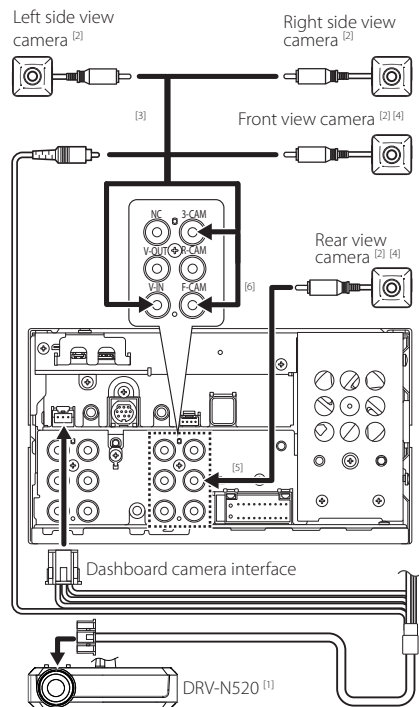

^[1] Optional accessory

^[2] Sold separately

^[3] Up to 3 cameras of Dashboard camera, Front view camera, Left side view camera and Right side view camera can be connected. For more information, see **Camera Assignment Settings (P.64)**.

^[4] CMOS-3xx series (optional accessory) or commercially available camera.

^[5] For HD video, connect an HD camera to Rear view camera input terminal. (DMX958XR only)

^[6] For HD video, connect an HD camera to Front view camera/Dashboard camera input terminal. (DMX958XR only)

Troubleshooting

Problems and Solutions

If any trouble occurs, first check the following table for possible problems.

NOTE

- Some functions of this unit may be disabled by some settings made on this unit.
- What might seem to be a malfunction in your unit may just be the result of slight misoperation or miswiring.

About settings

- **Cannot set up the subwoofer.**
- **Cannot set up subwoofer phase.**
- **No output from the subwoofer.**
- **Cannot set up the low pass filter.**
- **Cannot set up the high pass filter.**

Subwoofer is not set to on.

- Set the subwoofer to on. See *Speaker / X'over setup (P.76)*.

About audio operations

Radio reception is poor.

The car antenna is not extended.

- Pull out the antenna all the way.

The antenna control wire is not connected.

- Connect the wire correctly. See *Connecting the system and external components (P.92)*.

Cannot select a folder.

The random play function is enabled.

- Turn off the random function.

Others

The Touch Sensor Tone doesn't sound.

The preout jack is being used.

- The Touch Sensor Tone cannot be output from the preout jack.

Error Messages

When you fail to operate the unit correctly, the cause of the failure appears as the message on the screen.

There is an error in the speaker wiring. Please check the connections.

Protective circuit has been activated because a speaker cord has shorted or it has come in contact with the car chassis.

- Wire or insulate the speaker cord as appropriate and turn the power off and on again.

Hot Error

When the internal temperature of this unit rises to 60°C or more, the protection circuit is activated and you may not be able to operate the unit.

- Use the unit again after reducing the temperature of the unit.

Error 07-67

The unit is not operating correctly due to some reason or other.

- Turn the power off and on again. If the "Error 07-67" message does not disappear, contact your nearest KENWOOD dealer.

No Device (USB device)

The USB device is selected as a source although no USB device is connected.

- Change the source to any source other than USB/iPod. Connect a USB device, and change the source to USB again.

Disconnected (iPod, Bluetooth audio device)

The iPod/Bluetooth audio device is selected as a source although no iPod/Bluetooth audio device is connected.

- Change the source to any source other than iPod/Bluetooth. Connect an iPod/Bluetooth audio device, and change the source to iPod/Bluetooth again.

No Media file

The connected USB device contains no playable audio file. Media was played that does not have data recorded that the unit can play.

- See *Playable Media and Files (P.97)*.

USB device over current status detected.

The connected USB device is rated a current capacity higher than the allowable limit.

- Check the USB device. Some trouble may have occurred to the connected USB device.
- Change the source to any source other than USB. Remove the USB device.

SiriusXM

Check Tuner

A SiriusXM tuner is not connected to this unit.

- Verify that the SiriusXM Connect Vehicle Tuner cable is securely connected to the radio.

Subscription Updated - Press Return To Continue

The SiriusXM subscription has been renewed.

- Touching **Return** on the popup screen will clear the message.

SXM Chan Unavailable

The currently selected channel is unavailable.

- Visit www.siriusxm.com for more information about the SiriusXM channel lineup.

SXM Ch Unsubscribed

The currently selected channel is not subscribed to.

- In the U.S.A., visit www.siriusxm.com or call 1-866-635-2349 if you have questions about your subscription package or would like to subscribe to this channel.
- In Canada, visit www.siriusxm.ca/activate or call 1-888-539-7474.

SXM Check Antenna

No antenna is connected to the SiriusXM tuner.

- Check that an antenna is connected to the SiriusXM tuner. Check antenna for damages.

SXM No Signal

No SiriusXM radio signal is received.

- Verify that your vehicle is outdoors with a clear view of the sky.

Channel Locked

The selected channel has been locked by the parental controls.

- Enter the unlock code when you are asked. See **Parental Control (P.47)**.

Incorrect Pass Code entered

The selected channel is a mature or parental lock channel, and locked by the parental lock or user lock code.

- Enter the correct lock code.

Apple CarPlay

The GPS antenna must be connected to use Apple CarPlay wirelessly. Please verify the proper connections or plug in by USB to use Apple CarPlay.

The GPS antenna is not connected when the Apple CarPlay is started by connecting wirelessly or when the iPhone compatible with wireless Apple CarPlay is registered in **Device List**.

- Check the connection of the GPS antenna or plug in over USB to use Apple CarPlay.

Appendix

Playable Media and Files

You can play various kinds of media and files on this unit.

About files

The following audio and video files are supported.

■ Playable Audio files

	Format	Bit rate	Sampling frequency	Bit count
AAC-LC (.m4a)	MPEG-2/MPEG-4 AAC LC HE-AAC(V1,V2)	8 – 320kbps, VBR	16 – 48 kHz	16 bit
MP3 (.mp3)	MPEG-1/MPEG-2 Audio Layer 3	8 – 320kbps, VBR	16 – 48 kHz	16 bit
WMA (.wma)	Windows Media Audio Standard L3 profile (Version 7,8,9)	8 – 320kbps	16 – 48 kHz	16 bit
Linear PCM (WAVE) (.wav)	RIFF waveform Audio Format	–	16 – 192 kHz	16 bit/24 bit
FLAC (.flac, .fla)	flac	–	16 – 192 kHz	16 bit/24 bit
Vorbis (.ogg)	vorbis	–	16 – 48 kHz	16 bit

- WMA and AAC files with DRM cannot be played.
- Although the audio files complies with the standards listed above, they may not be played depending on the types or conditions of media or device.
- This unit supports playback of High-Resolution Audio files.
It is recommended that a car audio system should be configured with all High-Resolution Audio compatible products from player to speaker to enjoy its high quality sound.

■ Acceptable Video files

	Profile	Max. Picture size	Max. bit rate	Audio format
MPEG-1 (.mpg, .mpeg)	–	352 × 240, 352 × 288	1.5 Mbps	MPEG Audio Layer 2
MPEG-2 (.mpg, .mpeg)	MP@ML	720 × 480, 720 × 576	8 Mbps	MPEG Audio Layer 2
H.264/MPEG-4 AVC (.mp4, .m4v, .avi, .flv, .f4v)	Baseline Profile, Main Profile	1920 × 1080 (30 fps)	8 Mbps	MP3, AAC
MPEG-4 (.mp4, .avi)	Advanced Simple Profile	1920 × 1080 (30 fps)	8 Mbps	MP3, AAC
WMV (.wmv)	Main Profile	1920 × 1080 (30 fps)	8 Mbps	WMA
MKV (.mkv)	Video format follows H.264/MPEG-4 AVC, MPEG-4, WMV			MP3, AAC, WMA, Vorbis, FLAC

- This unit can only play back files which are smaller than 4 GB.

■ Limitation on structure of file and folder

	USB device
Maximum number of folder layers	8
Maximum number of files (per folder)	999
Maximum number of folders (per folder)	9999
Maximum number of folders (per device)	Unlimited

- You can enter a folder name and file name with 255 or fewer single-byte characters.
- Files in the folder whose folder name begins with a dot (.) cannot be played.

Specifications

■ Monitor section

Picture Size

- DMX958XR
 - : 6.75 inches (diagonal) wide
 - : 152.1 mm (W) × 79.5 mm (H)
 - 6 × 3-1/8 inch
- DMX908S / DMX9708S
 - : 6.95 inches (diagonal) wide
 - : 156.6 mm (W) × 81.6 mm (H)
 - 6-3/16 × 3-3/16 inch

Display System

- DMX958XR: AAS LCD panel
- DMX908S / DMX9708S: TN LCD panel

Drive System

- : TFT active matrix system

Number of Pixels

- DMX958XR
 - : 2,764,800 (1280H x 720V x RGB)
- DMX908S / DMX9708S
 - : 1,152,000 (800H x 480V x RGB)

Effective Pixels

- : 99.99 %

Pixel Arrangement

- : RGB striped arrangement

Back Lighting

- : LED

■ USB interface section

Connector type

- : Type-C

USB Standard

- : USB 2.0 High Speed

File System

- : FAT16, FAT32, exFAT, NTFS

Maximum Power Supply Current

- : DC 5 V  3.0 A × 1

D/A Converter

- : 24 bit/32 bit

Audio Decoder

- : MP3 / WMA / AAC / WAV / FLAC / Vorbis

Video Decoder

- : MPEG-1 / MPEG-2 / MPEG-4 / WMV / H.264

Frequency Response

- 192 kHz : 20 – 88,000 Hz
- 96 kHz : 20 – 44,000 Hz
- 48 kHz : 20 – 22,000 Hz
- 44.1 kHz : 20 – 20,000 Hz

Total Harmonic Distortion

- : 0.010 % (1 kHz)

S/N Ratio (dB)

- : 98.5 dB

Dynamic Range

- : 89 dB

■ Wireless Mirroring Section

Mode

- : Sink

Copyright protection

- : HDCP2.2

Touch Control

- : UIBC

■ Wi-Fi section

IEEE Standard

- : 802.11 a/b/g/n/ac

Frequency Range

- : Dual Band (2.4GHz/5GHz)

Channels

- : Auto(1-11ch)/Auto(149,153,157,161ch)

Transfer rates (MAX)

- : 11a: 54 Mbps / 11b: 11 Mbps / 11g: 54 Mbps /
11n: 300 Mbps / 11ac: 867 Mbps

■ Bluetooth section

Technology

- : Bluetooth Ver.5.0

Frequency

- : 2.402 – 2.480 GHz

Maximum Communication range

- : Line of sight approx. 10m (32.8 ft)

Audio Codec

- DMX958XR
 - : SBC / AAC / LDAC
- DMX908S / DMX9708S
 - : SBC / AAC

Profile (Multi Profile support)

- HFP (V1.7) (Hands Free Profile)
- SPP (Serial Port Profile)
- A2DP (Advanced Audio Distribution Profile)
- AVRCP (V1.6) (Audio/Video Remote Control Profile)
- PBAP (Phonebook Access Profile)

■ HDMI section

Connector type

: Type-D

Input Resolution

- VGA (640x480p @59.94Hz/60Hz)
- 480p (720x480p @59.94Hz/60Hz)
- 720p (1280x720p @59.94Hz/60Hz)

Input Audio Type

: 32K/44.1K/48K/88.2K/96K/176.2K/192K Hz
16 bit/20 bit/24 bit Linear PCM

■ DSP section

Graphics equalizer

Band: 13 Band

Frequency (BAND1 – 13)

: 62.5/100/160/250/400/630/1k/1.6k/2.5k/4k/6.3k/
10k/16k Hz

Gain

: -9/-8/-7/-6/-5/-4/-3/-2/-1/0/1/2/3/4/5/6/7/8/9 dB

2-way X'Over

High pass filter

Frequency: Through, 30/40/50/60/70/80/90/100/
120/150/180/220/250 Hz

Slope: -6/-12/-18/-24 dB/Oct.

Low pass filter

Frequency: 30/40/50/60/70/80/90/100/120/150/
180/220/250 Hz, Through

Slope: -6/-12/-18/-24 dB/Oct.

3-way X'Over (DMX958XR / DMX908S)

High pass filter

Frequency: 250/300/1k/1.6k/2.5k/4k/5k/6.3k/8k/
10k/12.5k Hz

Slope: -12/-18/-24 dB/Oct.

Band pass filter

Frequency: Through, 50/60/70/80/90/100/120/150/
180/220/250/300 Hz
250/300/1k/1.6k/2.5k/4k/5k/6.3k/8k Hz,
Through

Slope: -12/-18/-24 dB/Oct.

Low pass filter

Frequency: 30/40/50/60/70/80/90/100/120/150 Hz,
Through

Slope: -12/-18/-24 dB/Oct.

Position

Front/Rear/Subwoofer Delay

: 0 – 20.01 ft (0.03 or 0.04 ft Step)

Gain

: -8 – 0 dB

Subwoofer level

: -50 – +10 dB

■ Digital FM tuner section (DMX958XR / DMX908S)

Frequency Range (step)

: 87.9 MHz – 107.9 MHz (200 kHz)

Frequency Response (± 3.0 dB)

: 20 Hz – 20 kHz

S/N Ratio

: 80 dB (STEREO)

■ Digital AM tuner section (DMX958XR / DMX908S)

Frequency Range (step)

: 530 kHz – 1700 kHz (10 kHz)

Frequency Response (± 3.0 dB)

: 40 Hz – 15 kHz

S/N Ratio (dB)

: 80 dB (STEREO)

■ FM tuner section

Frequency Range (step)

: 87.9 MHz – 107.9 MHz (200 kHz)

Usable Sensitivity (S/N : 30 dB)

: 9.3 dBf (0.8 μ V/ 75 Ω)

Quieting Sensitivity (S/N : 46 dB)

: 10.2 dBf (1.13 μ V/ 75 Ω)

Frequency Response (± 3.0 dB)

: 30 Hz – 15 kHz

S/N Ratio (dB)

: 65 dB (MONO)

Selectivity (± 400 kHz)

: Over 80 dB

Stereo Separation

: 45 dB (1 kHz)

■ AM tuner section

Frequency Range (step)

: 530 kHz – 1700 kHz (10 kHz)

Usable Sensitivity

: 28 dB μ

Appendix

■ Video section

Color System of External Video Input

: NTSC/PAL

External Audio Max Input Level (mini jack)

: 2 V/25 k Ω

Video Input Level (RCA jacks)

: 1 V_{p-p}/75 Ω

Video Output Level (RCA jacks)

: 1 V_{p-p}/75 Ω

■ Audio section

Maximum Power (Front & Rear)

: 50 W \times 4

Typical Power Output (Front & Rear)

Full Bandwidth Power (at less than 1% THD)

: 22 W \times 4

Output frequency band

: 20 – 88,000 Hz

Preout Level (V)

(DMX958XR / DMX908S)

: 5 V/10 k Ω

(DMX9708S)

: 4 V/10 k Ω

Preout Impedance

: \leq 300 Ω

Speaker Impedance

: 4 – 8 Ω

■ General

Operating Voltage

: 12V DC car battery

Installation Dimensions (W \times H \times D)

: 178 \times 100 \times 85 mm

7 \times 3-15/16 \times 3-3/8 inch

With Sleeve

: 182 \times 112 \times 85 mm

7-3/16 \times 4-7/16 \times 3-3/8 inch

Weight with Sleeve

: 1.5 kg (3.2 lbs)

NOTE

- Although the effective pixels for the liquid crystal panel is given as 99.99% or more, 0.01% of pixels may not light or may light incorrectly.

Specifications are subject to change without prior notice.

About this Unit

■ Copyrights

- The Bluetooth® word mark and logos are registered trademarks owned by Bluetooth SIG, Inc. and any use of such marks by JVCENWOOD Corporation is under license. Other trademarks and trade names are those of their respective owners.
- USB Type-C® and USB-C® are registered trademarks of USB Implementers Forum.
- LDAC and LDAC logo are trademarks of Sony Corporation.
- Hi-Res Audio logo and Hi-Res Audio Wireless logo are used under license from Japan Audio Society.



- Windows Media is a registered trademark or trademark of Microsoft Corporation in the United States and/or other countries.
This product is protected by certain intellectual property rights of Microsoft. Use or distribution of such technology outside of this product is prohibited without a license from Microsoft.
- This software is based in part on the work of the independent JPEG Group.
- Use of the Made for Apple badge means that an accessory has been designed to connect specifically to the Apple product(s) identified in the badge and has been certified by the developer to meet Apple performance standards. Apple is not responsible for the operation of this device or its compliance with safety and regulatory standards. Please note that the use of this accessory with an Apple product may affect wireless performance.
- Apple, iPhone, iPod, iPod touch, and Lightning are trademarks of Apple Inc., registered in the U.S. and other countries.
- Apple, Siri, Apple CarPlay, Apple Music and Apple CarPlay logo are trademarks of Apple Inc., registered in the U.S. and other countries.
- App Store is a service mark of Apple Inc., registered in the U.S. and other countries.
- iOS is a trademark or registered trademark of Cisco in the U.S. and other countries and is used under license.
- SiriusXM and all related marks and logos are trademarks of Sirius XM Radio, Inc. All rights reserved.
- HD Radio Technology manufactured under license from iBiquity Digital Corporation. U.S. and Foreign Patents. For patents see <https://dts.com/patents>. HD Radio and the HD, HD Radio, and "ARC" logos are registered trademarks or trademarks of iBiquity Digital Corporation in the United States and/or other countries.
- INRIX is a registered trademark of INRIX, Inc.

- Google, Android, Google Play and Android Auto are trademarks of Google LLC.
- To use Android Auto on your car display, you'll need an Android Auto compatible vehicle or aftermarket stereo, an Android phone running Android 6.0 or higher, and the Android Auto app.
- Wi-Fi® is a registered trademark of Wi-Fi Alliance®.
- The Wi-Fi CERTIFIED™ Logo is a certification mark of Wi-Fi Alliance®.
- Copyright© 2018 Techpoint, Inc. All rights reserved.

HD-TVI™

- The terms HDMI, HDMI High-Definition Multimedia Interface, and the HDMI Logo are trademarks or registered trademarks of HDMI Licensing Administrator, Inc.
- Linux® is the registered trademark of Linus Torvalds in the U.S. and other countries.
- This product includes FontAvenue® fonts licensed by NEC Corporation. FontAvenue is a registered trademark of NEC Corporation.



- This product includes "Ubiquitous QuickBoot™" technology developed by Ubiquitous AI Corporation. Ubiquitous QuickBoot™ is a trademark of Ubiquitous AI Corporation.
Copyright© 2021 Ubiquitous AI Corporation All rights reserved.



- THIS PRODUCT IS LICENSED UNDER THE AVC PATENT PORTFOLIO LICENSE FOR THE PERSONAL USE OF A CONSUMER OR OTHER USES IN WHICH IT DOES NOT RECEIVE REMUNERATION TO (i) ENCODE VIDEO IN COMPLIANCE WITH THE AVC STANDARD ("AVC VIDEO") AND/OR (ii) DECODE AVC VIDEO THAT WAS ENCODED BY A CONSUMER ENGAGED IN A PERSONAL ACTIVITY AND/OR WAS OBTAINED FROM A VIDEO PROVIDER LICENSED TO PROVIDE AVC VIDEO. NO LICENSE IS GRANTED OR SHALL BE IMPLIED FOR ANY OTHER USE. ADDITIONAL INFORMATION MAY BE OBTAINED FROM MPEG LA, L.L.C. SEE [HTTP://WWW.MPEGLA.COM](http://www.mpegla.com)
- THIS PRODUCT IS LICENSED UNDER THE MPEG-4 VISUAL PATENT PORTFOLIO LICENSE FOR THE PERSONAL AND NON-COMMERCIAL USE OF A CONSUMER FOR (i) ENCODING VIDEO IN COMPLIANCE WITH THE MPEG-4 VISUAL STANDARD ("MPEG-4 VIDEO") AND/OR (ii) DECODING MPEG-4 VIDEO THAT WAS ENCODED BY A CONSUMER ENGAGED IN A PERSONAL AND NON-COMMERCIAL ACTIVITY AND/OR WAS OBTAINED FROM A VIDEO PROVIDER LICENSED BY MPEG LA TO PROVIDE MPEG-4 VIDEO. NO LICENSE IS GRANTED OR SHALL BE IMPLIED FOR ANY OTHER USE. ADDITIONAL INFORMATION INCLUDING THAT RELATING TO PROMOTIONAL, INTERNAL AND COMMERCIAL USES AND LICENSING MAY BE OBTAINED FROM MPEG LA, LLC. SEE [HTTP://WWW.MPEGLA.COM](http://www.mpegla.com).

Appendix

- THIS PRODUCT IS LICENSED UNDER THE VC-1 PATENT PORTFOLIO LICENSE FOR THE PERSONAL AND NON-COMMERCIAL USE OF A CONSUMER TO (i) ENCODE VIDEO IN COMPLIANCE WITH THE VC-1 STANDARD ("VC-1 VIDEO") AND/OR (ii) DECODE VC-1 VIDEO THAT WAS ENCODED BY A CONSUMER ENGAGED IN A PERSONAL AND NON-COMMERCIAL ACTIVITY AND/OR WAS OBTAINED FROM A VIDEO PROVIDER LICENSED TO PROVIDE VC-1 VIDEO. NO LICENSE IS GRANTED OR SHALL BE IMPLIED FOR ANY OTHER USE. ADDITIONAL INFORMATION MAY BE OBTAINED FROM MPEG LA, L.L.C. SEE [HTTP://WWW.MPEGLA.COM](http://www.mpegla.com)

- libFLAC

Copyright (C) 2000-2009 Josh Coalson
Copyright (C) 2011-2013 Xiph.Org Foundation
Redistribution and use in source and binary forms, with or without modification, are permitted provided that the following conditions are met:

- Redistributions of source code must retain the above copyright notice, this list of conditions and the following disclaimer.
- Redistributions in binary form must reproduce the above copyright notice, this list of conditions and the following disclaimer in the documentation and/or other materials provided with the distribution.

– Neither the name of the Xiph.org Foundation nor the names of its contributors may be used to endorse or promote products derived from this software without specific prior written permission. THIS SOFTWARE IS PROVIDED BY THE COPYRIGHT HOLDERS AND CONTRIBUTORS "AS IS" AND ANY EXPRESS OR IMPLIED WARRANTIES, INCLUDING, BUT NOT LIMITED TO, THE IMPLIED WARRANTIES OF MERCHANTABILITY AND FITNESS FOR A PARTICULAR PURPOSE ARE DISCLAIMED. IN NO EVENT SHALL THE FOUNDATION OR CONTRIBUTORS BE LIABLE FOR ANY DIRECT, INDIRECT, INCIDENTAL, SPECIAL, EXEMPLARY, OR CONSEQUENTIAL DAMAGES (INCLUDING, BUT NOT LIMITED TO, PROCUREMENT OF SUBSTITUTE GOODS OR SERVICES; LOSS OF USE, DATA, OR PROFITS; OR BUSINESS INTERRUPTION) HOWEVER CAUSED AND ON ANY THEORY OF LIABILITY, WHETHER IN CONTRACT, STRICT LIABILITY, OR TORT (INCLUDING NEGLIGENCE OR OTHERWISE) ARISING IN ANY WAY OUT OF THE USE OF THIS SOFTWARE, EVEN IF ADVISED OF THE POSSIBILITY OF SUCH DAMAGE.

- libvorbis

Copyright (c) 2002-2008 Xiph.org Foundation
Redistribution and use in source and binary forms, with or without modification, are permitted provided that the following conditions are met:

- Redistributions of source code must retain the above copyright notice, this list of conditions and the following disclaimer.
- Redistributions in binary form must reproduce the above copyright notice, this list of conditions and the following disclaimer in the documentation and/or other materials provided with the distribution.

- Neither the name of the Xiph.org Foundation nor the names of its contributors may be used to endorse or promote products derived from this software without specific prior written permission.

THIS SOFTWARE IS PROVIDED BY THE COPYRIGHT HOLDERS AND CONTRIBUTORS "AS IS" AND ANY EXPRESS OR IMPLIED WARRANTIES, INCLUDING, BUT NOT LIMITED TO, THE IMPLIED WARRANTIES OF MERCHANTABILITY AND FITNESS FOR A PARTICULAR PURPOSE ARE DISCLAIMED. IN NO EVENT SHALL THE FOUNDATION OR CONTRIBUTORS BE LIABLE FOR ANY DIRECT, INDIRECT, INCIDENTAL, SPECIAL, EXEMPLARY, OR CONSEQUENTIAL DAMAGES (INCLUDING, BUT NOT LIMITED TO, PROCUREMENT OF SUBSTITUTE GOODS OR SERVICES; LOSS OF USE, DATA, OR PROFITS; OR BUSINESS INTERRUPTION) HOWEVER CAUSED AND ON ANY THEORY OF LIABILITY, WHETHER IN CONTRACT, STRICT LIABILITY, OR TORT (INCLUDING NEGLIGENCE OR OTHERWISE) ARISING IN ANY WAY OUT OF THE USE OF THIS SOFTWARE, EVEN IF ADVISED OF THE POSSIBILITY OF SUCH DAMAGE.

- libogg

Copyright (c) 2002, Xiph.org Foundation
Redistribution and use in source and binary forms, with or without modification, are permitted provided that the following conditions are met:

- Redistributions of source code must retain the above copyright notice, this list of conditions and the following disclaimer.
- Redistributions in binary form must reproduce the above copyright notice, this list of conditions and the following disclaimer in the documentation and/or other materials provided with the distribution.

– Neither the name of the Xiph.org Foundation nor the names of its contributors may be used to endorse or promote products derived from this software without specific prior written permission.

THIS SOFTWARE IS PROVIDED BY THE COPYRIGHT HOLDERS AND CONTRIBUTORS "AS IS" AND ANY EXPRESS OR IMPLIED WARRANTIES, INCLUDING, BUT NOT LIMITED TO, THE IMPLIED WARRANTIES OF MERCHANTABILITY AND FITNESS FOR A PARTICULAR PURPOSE ARE DISCLAIMED. IN NO EVENT SHALL THE FOUNDATION OR CONTRIBUTORS BE LIABLE FOR ANY DIRECT, INDIRECT, INCIDENTAL, SPECIAL, EXEMPLARY, OR CONSEQUENTIAL DAMAGES (INCLUDING, BUT NOT LIMITED TO, PROCUREMENT OF SUBSTITUTE GOODS OR SERVICES; LOSS OF USE, DATA, OR PROFITS; OR BUSINESS INTERRUPTION) HOWEVER CAUSED AND ON ANY THEORY OF LIABILITY, WHETHER IN CONTRACT, STRICT LIABILITY, OR TORT (INCLUDING NEGLIGENCE OR OTHERWISE) ARISING IN ANY WAY OUT OF THE USE OF THIS SOFTWARE, EVEN IF ADVISED OF THE POSSIBILITY OF SUCH DAMAGE.

■ FCC CAUTION

Changes or modifications not expressly approved by the party responsible for compliance could void the user's authority to operate the equipment.

NOTE

- This equipment has been tested and found to comply with the limits for a Class B digital device, pursuant to part 15 of the FCC Rules. These limits are designed to provide reasonable protection against harmful interference in a residential installation.
- This equipment generates, uses and can radiate radio frequency energy and, if not installed and used in accordance with the instructions, may cause harmful interference to radio communications. However, there is no guarantee that interference will not occur in a particular installation. If this equipment does cause harmful interference to radio or television reception, which can be determined by turning the equipment off and on, the user is encouraged to try to correct the interference by one or more of the following measures:
 - Reorient or relocate the receiving antenna.
 - Increase the separation between the equipment and receiver.
 - Connect the equipment into an outlet on a circuit different from that to which the receiver is connected.
 - Consult the dealer or an experienced radio/TV technician for help.

This transmitter must not be co-located or operated in conjunction with any other antenna or transmitter.

■ ISED CAUTION

This device contains licence-exempt transmitter(s)/ receiver(s) that comply with Innovation, Science and Economic Development Canada's licence-exempt RSS(s).

Operation is subject to the following two conditions:

- (1) This device may not cause interference.
- (2) This device must accept any interference, including interference that may cause undesired operation of the device.

▲ CAUTION

This equipment complies with FCC/ISED radiation exposure limits set forth for an uncontrolled environment and meets the FCC radio frequency (RF) Exposure Guidelines and RSS-102 of the ISED radio frequency (RF) Exposure rules. This equipment should be installed and operated keeping the radiator at least 20cm or more away from person's body.

Supplier's Declaration of Conformity

Trade Name: KENWOOD
 Products: MONITOR WITH RECEIVER
 Model Name: DMX958XR / DMX908S / DMX9708S
 Responsible Party: JVCKENWOOD USA CORPORATION
 4001 Worsham Avenue,
 Long Beach, CA 90808, U.S.A.
 PHONE: 1-800-252-5722

THIS DEVICE COMPLIES WITH PART 15 OF THE FCC RULES. OPERATION IS SUBJECT TO THE FOLLOWING TWO CONDITIONS:

- (1) THIS DEVICE MAY NOT CAUSE HARMFUL INTERFERENCE, AND
- (2) THIS DEVICE MUST ACCEPT ANY INTERFERENCE RECEIVED, INCLUDING INTERFERENCE THAT MAY CAUSE UNDESIRED OPERATION.

■ Información acerca de la eliminación de equipos eléctricos y electrónicos al final de la vida útil (aplicable a los países que hayan adoptado sistemas independientes de recogida de residuos)



Los productos con el símbolo de un contenedor con ruedas tachado no podrán ser desechados como residuos domésticos.

Los equipos eléctricos y electrónicos al final de la vida útil, deberán ser reciclados en instalaciones que puedan dar el tratamiento adecuado a estos productos y a sus subproductos residuales correspondientes. Póngase en contacto con su administración local para obtener información sobre el punto de recogida más cercano. Un tratamiento correcto del reciclaje y la eliminación de residuos ayuda a conservar los recursos y evita al mismo tiempo efectos perjudiciales en la salud y el medio ambiente.

■ Informação sobre a eliminação de pilhas

Este produto não deve ser eliminado como lixo doméstico geral. Devolva a pilha usada ao revendedor ou entidade autorizada para que a mesma seja devolvida ao fabricante ou importador.

A reciclagem e a eliminação de lixo de maneira apropriada ajudarão a conservar os recursos naturais ao mesmo tempo que prevenirão os efeitos prejudiciais à nossa saúde e ao meio ambiente.

■ Para cumplimiento de la IFT:

La operación de este equipo esta sujeta a las siguientes dos condiciones:

- (1) es posible que este equipo o dispositivo no cause interferencia perjudicial y
- (2) este equipo o dispositivo debe aceptar cualquier interferencia, incluyendo la que pueda causar su operación no deseada.

android
auto

(((SiriusXM)))
READY

Made for
iPhone | iPod

Works with
Apple CarPlay



Hi-Res Audio logo and Hi-Res Audio
Wireless logo are used under license
from Japan Audio Society.



HD Radio®
This HD Radio receiver enables:

- HD2/HD3
- Bookmark
- Digital Sound
- Program Info
- Artist Experience
- Emergency Alerts

KENWOOD

DMX958XR DMX908S DMX9708S

MONITOR WITH RECEIVER

Quick Start Guide

MONITEUR AVEC RÉCEPTEUR

Guide de démarrage rapide

MONITOR CON RECEPTOR

Guía de inicio rápido

JVCKENWOOD Corporation

- Updated information (the latest Instruction Manual, system updates, new functions, etc.) is available from <<https://www.kenwood.com/cs/ce/>>.
- The Instruction manual is subject to change for modification of specifications and so forth. Be sure to download the latest edition of the Instruction manual for reference. <<https://www.kenwood.com/cs/ce/>>
- Des informations actualisées (le dernier mode d'emploi, les mises à jour du système, les nouvelles fonctions, etc.) sont disponibles sur le site <<https://www.kenwood.com/cs/ce/>>.
- Le mode d'emploi est susceptible d'être modifié suite aux changements pouvant être apportés aux spécifications etc. Téléchargez impérativement la dernière édition du mode d'emploi aux fins de référence. <<https://www.kenwood.com/cs/ce/>>
- La información actualizada (el Manual de instrucciones más actualizado, actualizaciones del sistema, nuevas funciones, etc.) está disponible desde <<https://www.kenwood.com/cs/ce/>>.
- El Manual de instrucciones está sujeto a cambios por modificaciones de las especificaciones, etc. Asegúrese de descargar la última edición del Manual de instrucciones a título de referencia. <<https://www.kenwood.com/cs/ce/>>

Take the time to read through this instruction manual.

Familiarity with installation and operation procedures will help you obtain the best performance from your new receiver.

For your records

Record the serial number, found on the top of the unit, in the spaces designated on the warranty card, and in the space provided below. Refer to the model and serial numbers whenever you call upon your KENWOOD dealer for information or service on the product.

Model DMX958XR / DMX908S / DMX9708S Serial number _____

US Residence Only

Register Online

Register your KENWOOD product at www.kenwood.com/usa/

Important Notice on Software

Software License on This Product

The software embedded in this product comprises a number of independent software components, each of which is copyrighted by JVCKENWOOD Corporation or by a third party. This product uses software components that are based on an End-User License Agreement (hereinafter called "EULA") stipulated by JVCKENWOOD Corporation and by third parties. The EULA dictates the availability of the source codes of free-software components as a prerequisite to distributing them in executable form under the terms of the GNU General Public License or the Lesser General Public License (hereinafter called "GPL/LGPL"). To get information about the software components that are subject to the terms of the GPL/LGPL, please visit the following Website:

Website URL <https://www2.jvckenwood.com/gpl/>

Queries concerning the contents of the source code or the like will not be accepted.

Please note that software components based on a EULA that is not subject to the terms of the GPL/LGPL or those that have been developed or created by JVCKENWOOD Corporation will be excluded from the scope of source code disclosure.

Because licenses to use software components distributed under the GPL/LGPL are offered to the customers for free of charge, no warranty is granted to the customers, whether explicitly or implicitly, to the extent of the applicable laws. Unless otherwise stipulated by the applicable laws or agreed upon in writing, the copyright holders or those who are entitled to modify and redistribute the software components are not held responsible for any and all damages resulting from their use or from inability to use them. For more information about the terms of use of the software components, required items of compliance and so on, please refer to the GPL/LGPL.

Customers wishing themselves to use a software component that is subject to the GPL/LGPL embedded in this product are encouraged to read the terms of the corresponding license before use. Because each individual license is prescribed by a third party other than

JVCKENWOOD Corporation, the original (English) of the license is presented.

EULA

Software License Agreement

JVCKENWOOD Corporation (hereinafter called "Licensor") holds either the copyright to the embedded software or the right to sublicense it. This agreement establishes the conditions under which the customer uses this "Licensed Software." The customer shall agree to the terms of this license agreement before proceeding to use Licensed Software.

This agreement is deemed to have taken effect when the customer (hereinafter called "User") has used a product implementation of Licensed Software.

The Licensed Software may contain software Licensor has been licensed to use by third parties directly or indirectly. Some third parties may have terms of use prescribed for their customers, apart from this Software License Agreement. This agreement does not apply to such software. Be sure to consult "Important Notice on Software" as presented separately.

Article 1 (General)

Licensor grants to User a non-exclusive, non-assignable right of use Licensed Software within the country where the User purchases the Product (hereinafter the "Country") (except for the exception provided for in Paragraph 1, Article 3).

Article 2 (Right of Use)

1. The rise of use granted under this agreement is the right to use Licensed Software in this product.
2. User may not duplicate, copy, modify, add to, translate or otherwise alter, or loan licensed Software and the associated literature in whole or in part.
3. Use of Licensed Software is limited to a private extent, and Licensed Software may not be distributed, licensed or sublicensed for any purposes whatsoever, including commercial use.
4. User shall use Licensed Software as per the instruction manual or instructions given in the help file and may not use or duplicate data in violations of the regulations of the Copyright Law or other governing laws by using Licensed Software in whole or in part.

Article 3 (Terms of License)

1. In assigning this product, User may not retain the original copy of the embedded Licensed Software (including associated literature, updates and upgrades) and any duplicates and associated literature with regard to the license to use Licensed Software. User may transfer Licensed Software only to the condition of binding the assignee to abide by the terms of this Software License Agreement.
2. User may not reverse-engineer, disassemble, decompile or otherwise analyze the source code of Licensed Software.

Article 4 (Rights to Licensed Software)

All rights to Licensed Software and the associated literature, including copyrights, shall reside with Licensor or the original right holder who has granted the Right of Use and right to sublicense to Licensor (hereinafter referred to as "Original Right Holder"), and User does not have any rights other than Right of Use granted hereunder with regard to Licensed Software and the associated literature.

Article 5 (Exemption Granted to Licensor)

1. Licensor and Original Right Holder do not assume any responsibility for damages caused to User or third parties resulting from the exercise by User of the license granted hereunder, unless otherwise provided by any law to the contrary.
2. Licensor does not warrant Licensed Software to be merchantable, compatible and fit for specific purposes.

Article 6 (Responsibility for Third Parties)

If disputes over the infringement of third parties' intellectual property rights, such as copyrights and patent rights, arise out of the use of Licensed Software by User, User shall resolve these disputes at User's own expenses while keep Licensor and Original Right Holder harmless.

Article 7 (Secrecy Obligation)

User shall keep confidential Licensed Software provided hereunder, information contained in the associated literature or the like and those provisions of this agreement not yet in public knowledge and may not disclose or leak these to third parties without prior written consent from Licensor.

Article 8 (Cancellation of the Agreement)

Licensor reserves the right to cancel this agreement forthwith and claim compensation from User for the damages caused by such cancellation when User:

- (1) Breaches any of the provisions of this agreement, or
- (2) Has received a petition for seizure, provisional seizure, provisional disposition or any other kind of compulsory execution.

Article 9 (Destruction of Licensed Software)

If this agreement is terminated under the provision of the foregoing paragraph, User shall destroy Licensed Software, along with all associated literature and its duplicates, within two (2) weeks from the date of termination.

Article 10 (Copyright Protection)

1. Copyrights and all other intellectual property rights relating to Licensed Software shall reside with Licensor and Original Right Holder and in no circumstances with User.
2. User shall abide by the laws relating to copyrights and intellectual property rights in using Licensed Software.

Article 11 (Export Control)

1. Licensed Software and the associated literature or the like may not be exported to places outside the Country (including transmission outside the Country over the Internet or the like).
2. User agrees that Licensed Software is subject to export controls imposed by the Country and the United States of America.
3. User agrees to comply with all the international and domestic laws that apply to this software (U.S. Export Administration Regulations and regulations established by the U.S., the Country and their governmental agencies regarding usage by end users and export destinations).

Article 12 (Miscellaneous)

1. Even if this agreement is invalidated in part by law, all other provisions shall remain in effect.
2. Licensor and User shall consult each other in good faith to resolve any matters not provided for in this agreement or questions arising from the interpretation of this agreement.
3. Licensor and User agree that this agreement is governed by the law of Japan and that all disputes involving claims and obligations that may arise out of this agreement will be settled by arbitration at the Tokyo District Court as the court of first instance.

Contents

Before Use	4
About the Quick start guide	4
How to read this manual	4
Precautions	5
Basic Operations	6
Functions of the Buttons on the Front Panel..	6
Turning on the Unit.....	6
Initial Settings	7
Adjusting the volume	8
Touch screen operations.....	9
Display the HOME screen	9
Pop up menu.....	10
Source selection screen description.....	10
Source control screen descriptions.....	12
List screen.....	12
USB/iPod.....	13
Connecting a USB device.....	13
Connect iPod/iPhone	13
USB/iPod Basic Operation	14
HD Radio™ Tuner/Radio	15
HD Radio Tuner Basic Operation	15
Radio Basic Operation.....	16
Memory Operation	16
Bluetooth Control.....	17
Register the Bluetooth device.....	17
Using the Hands-Free Unit	18
Controlling Audio	20
Connection/Installation	21
Before Installation	21
Installing the unit.....	23
Appendix.....	30
Note for specifications	30

Before Use

About the Quick start guide

- This Quick Start Guide describes basic functions of this unit. For functions not described in this Guide, refer to the Instruction Manual on the following website:
<https://www.kenwood.com/cs/ce/>



- The Instruction manual is subject to change for modification of specifications and so forth. Be sure to download the latest edition of the Instruction manual for reference.

How to read this manual

- The screens and panels shown in this manual are examples used to provide a clear explanation of operations. For this reason, they may be different from the actual screens or panels, or some display patterns may be different from the actual ones.
- **Display language:** English is used for the purpose of explanation. You can select a display language from the **SETUP** menu. See **User Interface Setup (P.70)** in the Instruction Manual.



This symbol on the product means there are important operating and maintenance instructions in this manual.

Be sure to carefully read instructions in this manual.

Precautions

▲ WARNINGS

■ To prevent injury or fire, take the following precautions:

- To prevent a short circuit, never put or leave any metallic objects (such as coins or metallic tools) inside the unit.
- Do not watch or fix your eyes on the unit's display when you are driving for any extended period.
- If you experience problems during installation, consult your KENWOOD dealer.

■ Precautions on using this unit

- When you purchase optional accessories, check with your KENWOOD dealer to make sure that they work with your model and in your area.
- You can select a language to display menus, audio file tags, etc. See **User Interface Setup (P.70)** in the Instruction Manual.
- The Radio Broadcast Data System feature won't work in areas where the service is not supported by any broadcasting station.

■ Protecting the monitor

- To protect the monitor from damage, do not operate the monitor using a ball point pen or similar tool with a sharp tip.

■ Cleaning the unit

- If the faceplate of this unit is stained, wipe it with a dry soft cloth such as a silicon cloth. If the faceplate is stained badly, wipe it with a cloth moistened with neutral cleaner, then wipe it again with a clean soft dry cloth.

NOTE

- Applying spray cleaner directly to the unit may damage its mechanical parts. Wiping the faceplate with a hard cloth or using a volatile liquid such as thinner or alcohol may scratch the surface or erase the screened print.

■ Acquiring GPS signal

The first time you turn on this unit, you must wait while the system acquires satellite signals for the first time. This process could take up to several minutes. Make sure your vehicle is outdoors in an open area away from tall buildings and trees for fastest acquisition. After the system acquires satellites for the first time, it will acquire satellites quickly each time thereafter.

■ About GLONASS

This unit uses Global Navigation Satellite System (GLONASS) in addition to GPS. Combining GPS and GLONASS can refine positioning accuracy than using GPS only.

■ Caution for Smartphone Users

Simultaneously running multiple applications on your smartphone while screen sharing places heavy demand on the microprocessor of the phone, potentially affecting communication and performance.

For best results while pairing with your Kenwood receiver, please be sure to close any unused applications.

Basic Operations

Functions of the Buttons on the Front Panel

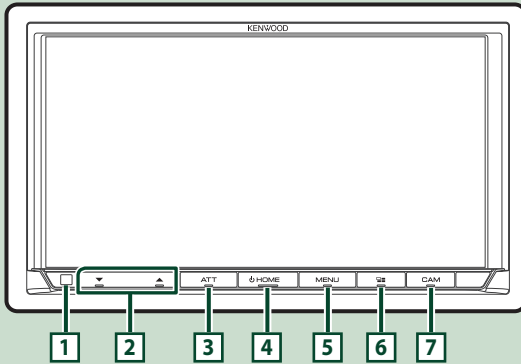

Number	Name	Motion
1	Remote Sensor	<ul style="list-style-type: none"> Receives the remote control signal.
2	▼, ▲ (Volume)	<ul style="list-style-type: none"> Adjusts the volume. The volume will go up to 15 when you keep pressing ▲. (P.8)
3	ATT	<ul style="list-style-type: none"> Switches attenuation of the volume on/off.
4	HOME	<ul style="list-style-type: none"> Displays the HOME screen (P.9). Pressing for 1 second turns the power off. When the power is off, turns the power on.
5	MENU	<ul style="list-style-type: none"> Displays the popup menu screen. Pressing for 1 second turns the screen off.
6		<ul style="list-style-type: none"> Displays the APP (Apple CarPlay/Android Auto/Wireless Mirroring) screen. Pressing and holding displays the Voice Recognition screen. When neither Apple CarPlay, Android Auto, nor a Bluetooth Hands-Free phone is connected, pressing and holding displays Bluetooth pairing waiting dialog.
7	CAM	<ul style="list-style-type: none"> Switches view camera display on/off. See Display the camera screen (P.64) in the Instruction Manual. The camera whose view is displayed first changes according to the "Camera Setup" setting and the shift lever position in the shift gate. The camera whose view was displayed last is kept and the same camera view will be displayed the next time. If its assignment setting is changed, the rear camera view is displayed.

Turning on the Unit

- 1 Press the **HOME** button.



➤ The unit is turned on.

- To turn off the unit

- 1 Press the **HOME** button for 1 second.

NOTE

- If it is your first time to turn the unit on after installation, it will be necessary to perform Initial SETUP (P.7).

Initial Settings

Initial SETUP

Perform this setup when you use this unit first time.

1 Set each item as follows.

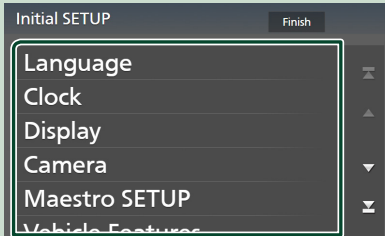

■ Language

Select the language used for the control screen and setting items. Default is "American English(en)".

- ① Touch **Language**.
- ② Touch **Language Select**.
- ③ Select the desired language.
- ④ Touch **↩**.

For details, see **User Interface Setup (P.70)** in the Instruction Manual.

■ Clock

Sets the synchronization of the clock and adjusts it.

For details, see **Date and clock settings (P.8)**.

■ Display

Set the key illumination color.

If it is hard to see the image on the screen even, adjust the viewing angle.

- ① Touch **Display**.
- ② Touch **Key Color**.
- ③ Select the desired color.
- ④ Touch **↩**.
- ⑤ Touch **Viewing Angle**.
- ⑥ Select a viewing angle.
- ⑦ Touch **↩**.

For details, see **Display Setup (P.71)** in the Instruction Manual.

■ Camera

Set the parameters for the camera.

- ① Touch **Camera**.
- ② Set each item and touch **↩**.

For details, see **Camera Setup (P.64)** in the Instruction Manual.

■ Maestro SETUP

This function requires a commercial adaptor. Consult your KENWOOD dealer for details.

■ Vehicle Features

This function requires a commercial adaptor. Consult your KENWOOD dealer for details.

■ DEMO

Set the demonstration mode. Default is "ON".

2 Touch Finish.

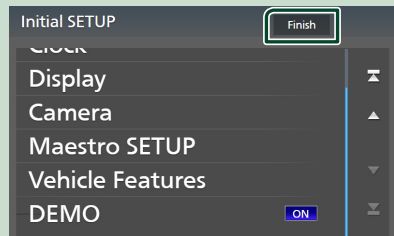

NOTE

- These settings can be made from the SETUP menu. See **Setup (P.69)** in the Instruction Manual.

Date and clock settings

1 Press the **MENU** button.

➤ Popup menu appears.

2 Touch **SETUP**.



➤ SETUP Menu screen appears.

3 Touch **User Interface**.

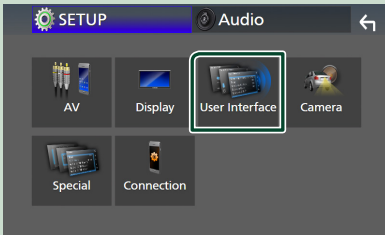

➤ User Interface screen appears.

4 Set each item as follows.

Scroll the page to show hidden items.

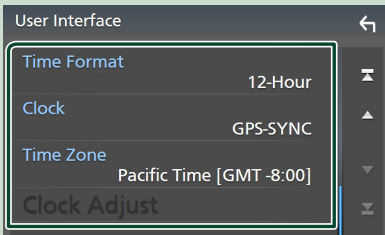

Time Format

Select the time display format.

12-Hour (Default)/ **24-Hour**

Clock

GPS-SYNC (Default): Synchronizes the clock time with the GPS.

Manual: Set the clock manually.

Time Zone

Select the time zone.

Clock Adjust

If you select **Manual** for Clock, adjust the date and time manually. **(P.8)**

NOTE

- Please set the date and time. If they are not set, some functions may not work.

Adjust the date and time manually

1 Touch **Clock Adjust** on the User Interface screen.

2 Adjust the date, then adjust the time.

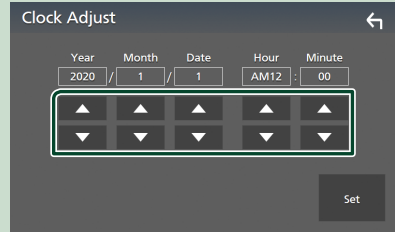

3 Touch **Set**.

Adjusting the volume

You can adjust the volume (0 to 40).

Press **▲** to increase, and press **▼** to decrease.

Holding **▲** increases the volume continuously to level 15.



Touch screen operations

To perform operations on the screen, you need to touch, touch and hold, flick or swipe to select an item, display a setting menu screen or change pages.

● Touch

Touch the screen gently to select an item on the screen.

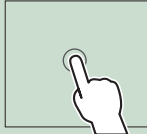

● Touch and hold

Touch the screen and keep your finger in place until the display changes or a message is displayed.

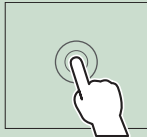

● Flick

Slide your finger quickly to the left or right on the screen to change the page. You can scroll a list screen by flicking up/down on the screen.



● Swipe

Slide your finger up or down on the screen to scroll the screen.



Display the HOME screen

1 Press the HOME button.



> HOME screen appears.

HOME screen descriptions

Most functions can be performed from the HOME screen.



- 1 • Widget
 - You can change the widget by flicking left or right on the widget area.
 - Touch the widget to display the detailed screen.
- 2 • Displays the source selection screen. (P.10)
- 3 • Short-cut playback source icons (P.10)

Widget

- 1 Press the **HOME** button.
 - HOME screen appears.
- 2 You can change the widget by flicking left or right on the widget area.



Popup menu

- 1 Press the **MENU** button.
 - Popup menu appears.
- 2 Touch to display the popup menu.



The contents of the menu are as follows.

	• Displays the Screen Adjustment screen.
	• Turns the display off. To turn on the screen: Touch the display.
	• Displays the view camera screen.
	• Displays the SETUP Menu screen.
	• Displays the Audio screen. (P.20)

	• Displays the control screen of current source. Icon feature differs depending on the source. This icon is for USB source.
	• Close the popup menu.
	• Displays the Device List screen. (P.17)
1	• Short-cut source icons: The source changes to the one you have set with a short-cut. For the short-cut setting, refer to Customize Short-cut source icons on HOME screen (P.11) .

Source selection screen description

You can display icons of all playback sources and options on the source selection screen.

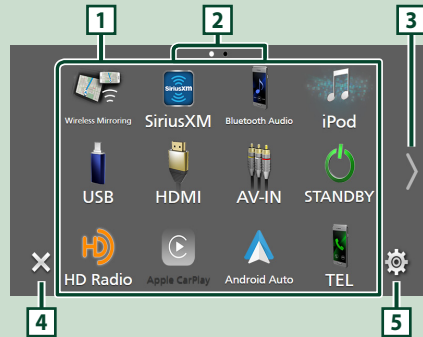









- 1 • Changes playback sources.
For playback sources, see **Select the playback source (P.11)**.
- 2 • Page indication
- 3 • Changes pages. (Touch)
You can also change pages by flicking left or right on the screen.
- 4 • Returns to the previous screen.
- 5 • Displays the SETUP Menu screen.

Select the playback source

- 1 Press the **HOME** button.
➤ HOME screen appears.

- 2 Touch .

From the screen, you can select the following sources and functions.

	• Switches to the Apple CarPlay screen from the connected iPhone.
	• Switches to the Android Auto screen from the connected Android™ smartphone.
	• Displays the Hands-Free screen. (P.18) When neither Apple CarPlay, Android Auto, nor a Bluetooth Hands-Free phone is connected, displays Bluetooth pairing waiting dialog.*1
	• Switches to the Radio broadcast.*2 (P.16)
	• Switches to the HD Radio broadcast.*3 (P.15)
	• Switches to the SiriusXM® satellite radio broadcast.
	• Plays a Bluetooth audio device.
	• Plays an iPod/iPhone. (P.14)
	• Plays files on a USB device. (P.14)
	• Plays a device connected to the HDMI input terminal.
	• Switches to an external component connected to the AV Audio input and the VIDEO input terminal.*4 *5
	• Switches to the Wireless Mirroring screen from the connected Android™ smartphone.
	• Puts the unit in standby. (P.11)

*1 When connecting as Apple CarPlay or Android Auto, it works as a phone provided in Apple CarPlay or Android Auto. If Apple CarPlay or Android Auto are connected during talking by the Bluetooth device or iDataLink phone, the current call will be continued.

*2 DMX9708S only

*3 DMX958XR / DMX908S only

*4 You can use the **AV-IN** source when a cable from a visual source except a camera is connected to the VIDEO input terminal, and a cable is connected to the AV Audio input terminal. **(P.26)**

*5 This can be selected when the AV-IN is set to **NONE** on the Camera Assignment Setting screen. **(P.30)**

Put the unit in standby

- 1 Press the **HOME** button.
➤ HOME screen appears.

- 2 Touch .

- 3 Touch **STANDBY**.



Customize Short-cut source icons on HOME screen

You can arrange the positions of the source icons as you like.

- 1 Press the **HOME** button.
➤ HOME screen appears.

- 2 Touch .

- 3 Touch and hold the icon which you want to move in the customizing mode.

- 4 Drag the icon to the desired position.



Source control screen descriptions

There are some functions which can be performed from most screens.

Indicators

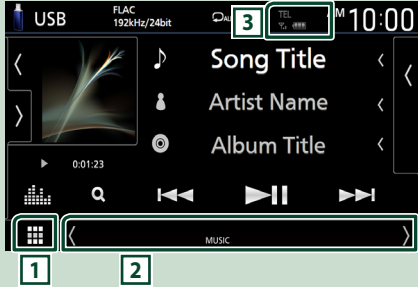

Short-cut source icons



1 All sources icon

Displays the source selection screen. (P.10)

2 Secondary screen

- : The Secondary screen changes to another one every time you touch it. You can also change the Secondary screen by flicking left or right on the screen.
- Indicators: Displays the current source condition and so on.
 - **ATT**: The attenuator is active.
 - **MUTE**: The mute function is active.
 - **LOUD**: The loudness control function is active.
- Short-cut source icons: The source changes to the one you have set with a short-cut. For the short-cut setting, refer to **Customize Short-cut source icons on HOME screen (P.11)**.

3 TEL

- Connected Bluetooth device information.

List screen

There are some common function keys in the list screens of most sources.

The operation and the display screen are different for each source.

Display the list screen

1 Touch Q.



▶ The list screen appears.

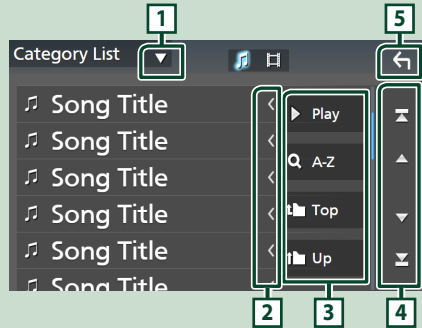

1

Displays the list type selection window.

2 Text scroll

Scrolls the displayed text.

3 Play etc.

Keys with various functions are displayed here.

- **Play**: Plays all tracks in the folder containing the current track.
- **A-Z**: Jumps to the letter you entered (alphabetical search).
- **Top** **Up**: Moves to the upper hierarchy level.

4 / Page scroll

You can change pages to display more items by touching / .

- / : Displays the top or bottom page.

5 Return

Returns to the previous screen.

USB/iPod

Connecting a USB device

- 1 Connect the USB device via the USB terminal. (P.27)

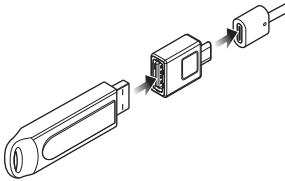

- 2 Press the **HOME** button.
- 3 Touch .
- 4 Touch **USB**. (P.11)

Disconnect the USB device

- 1 Press the **HOME** button.
- 2 Touch a source other than **USB**.
- 3 Detach the USB device.

Usable USB device

You can use a mass-storage-class USB device with this unit.

The word “USB device” appearing in this manual indicates a flash memory device.

Connect iPod/iPhone

Preparation

- With an iPhone compatible with Apple CarPlay, turn off Apple CarPlay by operating the iPhone at functional setup before connecting iPhone. For details of the setup method, contact the manufacturer of the terminal.
- Only one iPod/iPhone can be connected.

Wired connection

Preparation

- Connect an iPod/iPhone while Apple CarPlay is not connected.

- 1 Connect your iPod/iPhone via the USB terminal by the following methods. (P.28)

- Connect using KCA-iP103 (optional accessory) and USB adaptor.
- Connect using USB-C to Lightning cable (sold separately).

● To disconnect the iPod/iPhone connected with the cable

- 1 Detach the iPod/iPhone.

Bluetooth connection

Pair the iPhone through Bluetooth.

Preparation

- To connect an iPhone via Bluetooth, register it as a Bluetooth device and do the profile setting for the connection beforehand. See **Register the Bluetooth device (P.17)**.
- Connect an iPhone via Bluetooth while Apple CarPlay and an iPod/iPhone are not connected via USB.

Connectable iPod/iPhone

The following models can be connected to this unit.

Made for



- iPhone 12 Pro Max
- iPhone 12 Pro
- iPhone 12
- iPhone 12 mini
- iPhone SE (2nd generation)
- iPhone 11 Pro Max
- iPhone 11 Pro
- iPhone 11
- iPhone XS Max
- iPhone XS
- iPhone XR
- iPhone X
- iPhone 8 Plus
- iPhone 8
- iPhone 7 Plus
- iPhone 7
- iPhone SE
- iPhone 6s Plus
- iPhone 6s
- iPod touch (7th generation)

USB/iPod Basic Operation

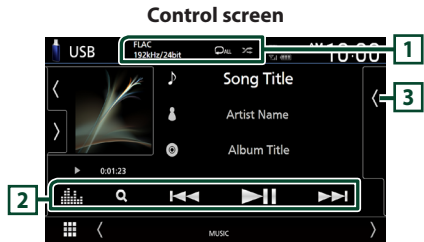



- 1 Press the **HOME** button.
- 2 Touch .
- 3 Touch **USB or iPod**. (P.11)



1 CODEC/Repeat/Random

- When a high-resolution source is played, its format information is displayed.
-  : Repeats the current track/folder.
-  : Randomly plays all tracks in the current folder.

2 Operation keys

-  : Searches track/file.
-  : Searches the previous/next track/file.
Touch and hold to fast forward or fast backward. (It will be cancelled automatically after about 50 seconds.)
-  : Plays or pauses.
-  : Displays the Graphic Equalizer screen. (P.20)

3 Content list

- Touch the right side of the screen to display the Content list. Touch again to close the list.
- Displays the playing list. When you touch a track/file name on the list, playback will start.

HD Radio™ Tuner/Radio

HD Radio Tuner Basic Operation (DMX958XR / DMX908S)

To listen to the HD Radio source, touch **HD Radio** icon on the source selection screen. (P.11)

NOTE

- HD Radio broadcasting is for North American sales area only.
- The screen shot below is for tuner. It may be different from the one for HD Radio broadcasting.

Control screen

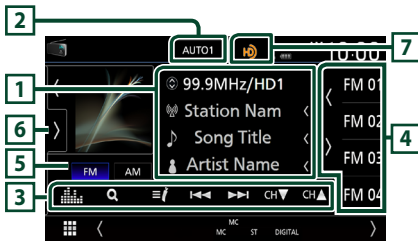

1 Information display

- Displays the information on the current station: Frequency and Channel
Touching allows you to switch between Content A, Content B and Content C.
Content A: Station name, Song Title, Artist Name
Content B: Station Message, Radio Text
Content C: PTY Genre, Album Name

2 Seek mode

Touch to switch seek mode in the following sequence: **AUTO1**, **AUTO2**, **MANUAL**.

- **AUTO1**: Tunes in a station with good reception automatically.
- **AUTO2**: Tunes in the memorized stations one after another.
- **MANUAL**: Switches to the next frequency manually.

3 Operation keys

- : Tunes in a station. The method of switching frequencies can be changed (see [2](#) Seek mode).

- **CH▼ CH▲**: Selects a channel.
- : Display the Channel List screen.
- : Display a list of registered bookmarks.
- : Displays the Graphic Equalizer screen. (P.20)

4 Preset list

- Touching allows you to change the display size.
- Recalls the memorized station or channel.
- When touched for 2 seconds, stores the currently being received station or channel in the memory.

5 Band keys

Switches bands (between FM and AM).

6 Function panel

Touch the left side of the screen to display the function panel. Touch again to close the panel.

- **10key Direct**: Display the direct station/channel search screen.
- **AME**: Presets stations automatically. (P.16)
- **RCV**: Change the HD Radio reception mode.
Auto: Switch between digital and analog audio automatically.
Digital: Select this to tune to digital audio only.
Analog: Select this to tune to analog audio only.
- **PTY** (FM only): Searches for a program by program type.
- : Stores the information about the song being received.
- **Emergency Alerts**: Turn on or off the alert message.
- **Alert Message Log**: Displays the alert message received.

7 Indicator display

While receiving an HD Radio station, it lights with orange when the audio is digital and lights with gray when it is analog. While receiving an analog station, it is off.

Radio Basic Operation (DMX9708S)

To listen to the Radio source, touch **Radio** icon on the source selection screen. (P.11)

Control screen



1 Information display

- Displays the information on the current station:
Frequency
Touching allows you to switch between Content A and Content B.
Content A: PS name, Radio Text, Title & Artist
Content B: PTY Genre, Radio Text plus
Preset#: Preset number

2 Seek mode

Touch to switch seek mode in the following sequence: **AUTO1**, **AUTO2**, **MANUAL**.

- **AUTO1**: Tunes in a station with good reception automatically.
- **AUTO2**: Tunes in the memorized stations one after another.
- **MANUAL**: Switches to the next frequency manually.

3 Operation keys

- : Tunes in a station. The method of switching frequencies can be changed (see [2](#) Seek mode).
- : Displays the Graphic Equalizer screen. (P.20)

4 Preset list

- Touching allows you to change the display size.
- Recalls the memorized station.
- When touched for 2 seconds, stores the currently being received station in the memory.

5 Band keys

Switches bands (between FM and AM).

6 Function panel

Touch the left side of the screen to display the function panel. Touch again to close the panel.

- **TI** (FM only): Selects the traffic information mode.
- **AME**: Presets stations automatically. (P.16)
- **PTY** (FM only): Searches for a program by program type.
- **MONO** (FM only): Selects the Monaural reception mode.

Memory Operation

Auto memory

You can store stations with good reception in the memory automatically.

- 1 Touch desired band key.
- 2 Touch on the left side of the screen. Touch **AME**.
- 3 Touch **Yes**.
➤ Auto memory starts.

Manual memory

You can store the currently being received station or channel in the memory.

- 1 Select the station or channel you wish to store in the memory.
- 2 Touch **FM#** (#:1-15) or **AM#** (#:1-5) in which you want to store the station or channel for 2 seconds until a beep sounds.

Preset select

- 1 Touch on the right side of the screen. Select a station or channel from the list.

Bluetooth Control

Register the Bluetooth device

It is necessary to register the Bluetooth audio device or smartphone/cell-phone in this unit before using the Bluetooth function.

- 1 Press the **MENU** button.
 - Popup menu appears.
- 2 Touch **SETUP**.
 - SETUP Menu screen appears.
- 3 Touch **Connection**.
 - Connection Setup screen appears.
- 4 Touch **Device List** on the Connection Setup screen.

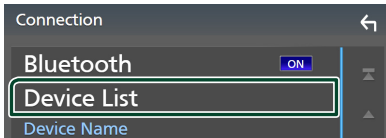

- 5 Touch **+ [Device Icon]** on the Device List screen.

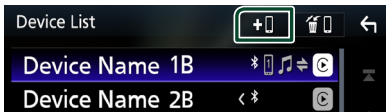

- Bluetooth pairing waiting dialog appears.

- 6 Search for the unit ("DMX****") from your smartphone/cell-phone.

Complete steps 6 to 8 within 30 seconds.

- 7 Operate your smartphone/cell-phone according to the displayed messages.

- **Confirm the request both on the smartphone/cell-phone.**

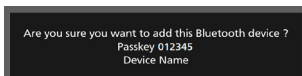

- **Input the PIN Code in your smartphone/cell-phone.**

PIN Code is set to "0000" as the default.

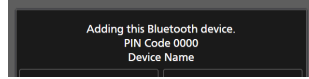

- 8 Touch **Yes**.

When data transmission and connection have completed, the Bluetooth connection icon appears on the screen.

NOTE

- When registering the iPhone that is available for Apple CarPlay wirelessly, a confirmation message appears. Touch **Yes** to display the Apple CarPlay screen for wireless connection.
- The device name selected on step 6 can be changed. See **Change the device name for Bluetooth (P.74)** in the Instruction Manual.

Using the Hands-Free Unit

You can use the telephone function by connecting the Bluetooth telephone to this unit.

NOTE

- If you use the Hands-Free function frequently, move the TEL short-cut key (icon) to the Home screen. **(P.11)**
- While using the Bluetooth Hands-Free function, Apple CarPlay or Android Auto is not available.
- While Apple CarPlay or Android Auto is connected, the Bluetooth Hands-Free function and two Bluetooth devices connections cannot be used. Only the Apple CarPlay or Android Auto Hands-Free function can be used.

Make a call

- 1 Press the **HOME** button.
- 2 Touch .
- 3 Touch **TEL**.

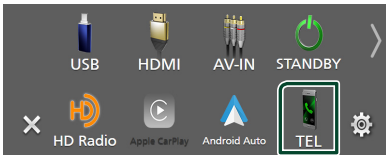



▶ Hands-Free screen appears.

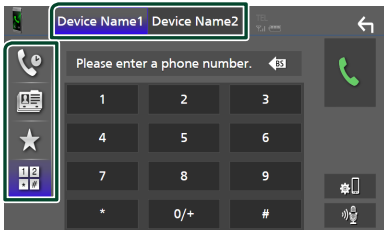

NOTE

- If your smartphone/cell-phone supports PBAP, you can display the phone book and call lists onto the touch panel screen when the smartphone/cell-phone is connected.
 - Phone book: up to 1000 entries
 - Up to 50 entries including dialed calls, received calls, and missed calls

4 Select a dialing method.





- : Call using call records
- : Call using the phonebook

- : Call using the preset number
- : Call by entering a phone number

● Select the smartphone/cell-phone to use



When you connect two smartphones/cell-phones

- 1) Touch   to select the phone you want to use.

Call using call records

- 1 Touch .
- 2 Select the phone number from the list.

Call using the phonebook

- 1 Touch .
- 2 Touch  **A-Z**.
- 3 Select the initial.
 - Characters with no corresponding name will not appear.
 - A first character with an accent character such as “ü” can be searched for with a non-accent character “u”. A character with an accent character in a sentence cannot be searched for.
- 4 Select the person you want to call from the list.

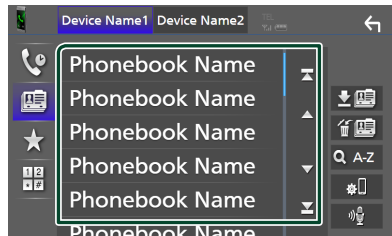

5 Select the phone number from the list.

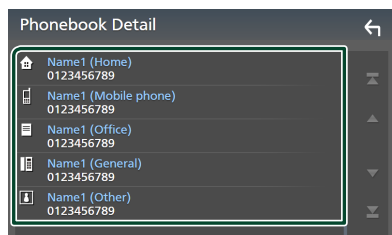



NOTE

- You can sort the phone numbers in the list by last name or first name. For details, see **Hands-Free Setup (P.63)** in the Instruction Manual.



Call using the preset number

- 1 Touch .
- 2 Touch the name or phone number.

Call by entering a phone number

- 1 Touch .
- 2 Enter a phone number with number keys.
- 3 Touch .

Receive a call

- 1 Touch  to answer a phone call or  to reject an incoming call.

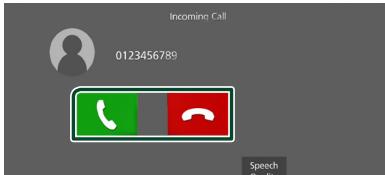
**NOTE**

- When shifting the gear to the reverse (R) position and monitoring the picture from the rear view camera, this screen does not appear even if a call comes in.
- The portrait registered in the phonebook is displayed while making/receiving calls and during a call.
- If you edit the phonebook on the connected device side after downloading the phonebook, the portrait may not be displayed depending on the edited content. It is recommended that you download the phonebook whenever you edit it.
- The image quality of a displayed portrait may depend on a connected device.

To end call

- 1 While talking, touch .

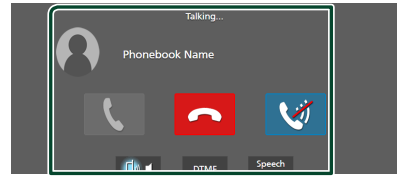
Operations during a call**● Adjust the volume of your voice**

- 1) Touch **Speech Quality**.
- 2) Touch ◀ or ▶ for **Microphone Level**.

● Adjust the receiver volume

Press the ▼ or ▲ button.

● Mute your voice

Touch  to mute or not to mute your voice.

● Output the dial tone

Touch **DTMF** to display the tone input screen. You can send tones by touching desired keys on the screen.

● Switching between speaking voice output destinations

Touching  /  each time switches speaking voice output destinations between the smartphone/cell-phone and the speaker.

Controlling Audio

You can adjust various settings such as audio balance or subwoofer level.

- 1 Press the **MENU** button.
 ▶ Popup menu appears.

- 2 Touch **Audio**.

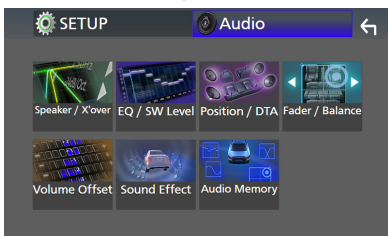
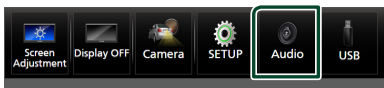

Controlling General Audio

- 1 Touch **Fader / Balance**.
- 2 Set each parameter as follows.

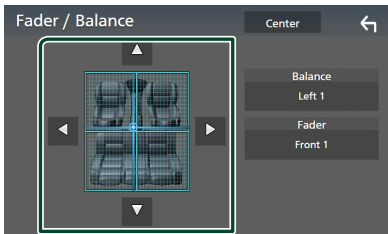

Fader, Balance

Adjust the volume balance around the touched area.

◀ and ▶ adjust the right and left volume balance.

▲ and ▼ adjust the front and rear volume balance.

Center

Clear the adjustment.

Equalizer Control

You can adjust equalizer by selecting the optimized setting for each category.

- 1 Touch **EQ / SW Level**.
- 2 Touch the screen and set the **Graphic Equalizer** as desired.

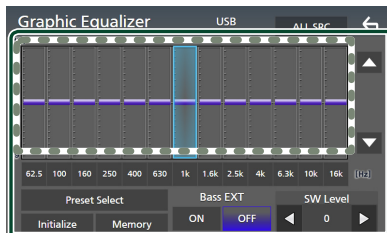

Gain level (area in dotted frame)

Adjust the gain level by touching each frequency bar.

You can select a frequency bar and adjust its level by ▲, ▼.

Preset Select

Display the screen for selecting the preset equalizer curve.

Memory

Saves the adjusted equalizer curve as "User1" to "User4".

Initialize

Initialize (flatten) the current EQ curve.

ALL SRC

Apply the adjusted equalizer curve to all sources. Touch **ALL SRC** and then touch **OK** on the confirmation screen.

Bass EXT (Bass Extend Settings)

When turned on, the frequencies lower than 62.5 Hz is set to the same gain level (62.5 Hz).

SW Level

Adjust the subwoofer volume.

Connection/Installation

This section is for the professional installer. For safety's sake, leave wiring and mounting to professionals. Consult the car audio dealer.

Before Installation

Before installation of this unit, please note the following precautions.

▲ WARNINGS

- If you connect the ignition wire (red) and the battery wire (yellow) to the car chassis (ground), you may cause a short circuit, that in turn may start a fire. Always connect those wires to the power source running through the fuse box.
- Do not cut out the fuse from the ignition wire (red) and the battery wire (yellow). The power supply must be connected to the wires via the fuse.

▲ CAUTION

- Install this unit in the console of your vehicle. Do not touch the metal part of this unit during and shortly after the use of the unit. Metal part such as the heat sink and enclosure become hot.

NOTE

- Mounting and wiring this product requires skills and experience. For best safety, leave the mounting and wiring work to professionals.
- Make sure to ground the unit to a negative 12V DC power supply.
- Do not install the unit in a spot exposed to direct sunlight or excessive heat or humidity. Also avoid places with too much dust or the possibility of water splashing.
- Do not use your own screws. Use only the screws provided. If you use the wrong screws, you could damage the unit.
- If the power is not turned ON ("There is an error in the speaker wiring. Please check the connections." is displayed), the speaker wire may have a short-circuit or touched the chassis of the vehicle and the protection function may have been activated. Therefore, the speaker wire should be checked.

- If your car's ignition does not have an ACC position, connect the ignition wires to a power source that can be turned on and off with the ignition key. If you connect the ignition wire to a power source with a constant voltage supply, such as with battery wires, the battery may be drained.
- If the console has a lid, make sure to install the unit so that the front panel will not hit the lid when closing and opening.
- If the fuse blows, first make sure the wires are not touching to cause a short circuit, then replace the old fuse with one with the same rating.
- Insulate unconnected wires with vinyl tape or other similar material. To prevent a short circuit, do not remove the caps on the ends of the unconnected wires or the terminals.
- Connect the speaker wires correctly to the terminals to which they correspond. The unit may be damaged or fail to work if you share the ⊖ wires or ground them to any metal part in the car.
- When only two speakers are being connected to the system, connect the connectors either to both the front output terminals or to both the rear output terminals (do not mix front and rear). For example, if you connect the ⊕ connector of the left speaker to a front output terminal, do not connect the ⊖ connector to a rear output terminal.
- After the unit is installed, check whether the brake lamps, blinkers, wipers, etc. on the car are working properly.
- This unit has the cooling fan to decrease the internal temperature. Do not mount the unit in a place where the cooling fan of the unit is blocked. Blocking these openings will inhibit the cooling of the internal temperature and result in malfunction.

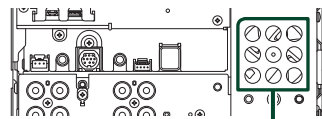

Cooling fan

- Mount the unit so that the mounting angle is 30° or less.

Connection/Installation

- Do not connect anything to the terminal printed with "NC". "NC" means "Non Connection" or "No Connecting". If other signals are supplied to the terminal, the unit may not work properly.
- Do not press hard on the panel surface when installing the unit to the vehicle. Otherwise scars, damage, or failure may result.
- Reception may drop if there are metal objects near the Bluetooth/Wi-Fi antenna.

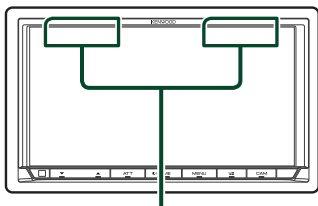

Bluetooth/Wi-Fi antenna unit

Supplied accessories for installation

①		x1
②	(1 m)	x1
③		x1
④	(3 m)	x1
⑤		x2
⑥	(M5 x 8 mm)	x6

⑦	(M5 x 8 mm)	x6
⑧		x1
⑨	(3.5 m)	x1
⑩		x1

Installation procedure

- 1) To prevent a short circuit, remove the key from the ignition and disconnect the \ominus terminal of the battery.
- 2) Make the proper input and output wire connections for each unit.
- 3) Connect the speaker wires of the wiring harness.
- 4) Connect the wiring harness wires in the following order; ground, battery, ignition.
- 5) Connect the wiring harness connector to the unit.
- 6) Install the unit in your car.
- 7) Reconnect the \ominus terminal of the battery.
- 8) Perform the Initial Setup.
See **Initial SETUP (P.7)**.

Installing the unit

Non-Japanese cars

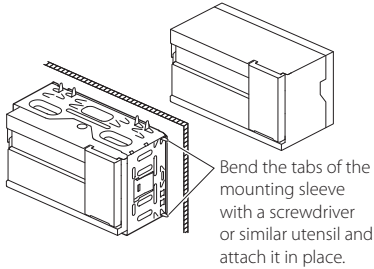

Japanese cars

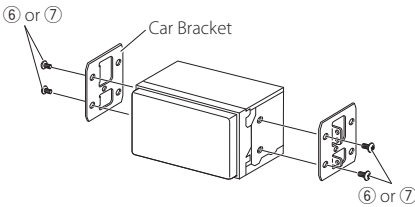

NOTE

- Make sure that the unit is installed securely in place. If the unit is unstable, it may malfunction (eg, the sound may skip).

Trim plate

- 1) Attach accessory (8) to the unit.

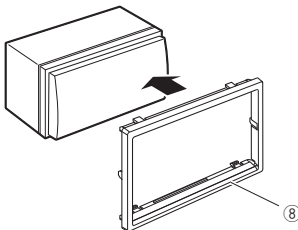

GPS antenna

GPS antenna is installed inside of the car. It should be installed as horizontally as possible to allow easy reception of the GPS satellite signals.

To mount the GPS antenna inside your vehicle:

- 1) Clean your dashboard or other surface.
- 2) Remove the separator of the metal plate (accessory (10)).
- 3) Press the metal plate (accessory (10)) down firmly on your dashboard or other mounting surface. You can bend the metal plate (accessory (10)) to conform to a curved surface, if necessary.
- 4) Remove the separator of the GPS antenna (accessory (9)), and stick the antenna to the metal plate (accessory (10)).

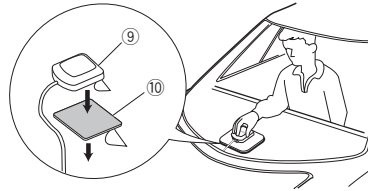

NOTE

- Use the supplied GPS antenna. Using the GPS antenna other than the supplied one may cause a drop in positioning accuracy.
- Depending on the type of car, reception of the GPS satellite signals might not be possible with an inside installation.
- Please install this GPS antenna in an area away from any antennas that are used with CB radios or satellite televisions.
- The GPS antenna should be installed at a position that is spaced at least 12 inch (30 cm) from smartphone/cell-phone or other transmitting antennas. Signals from the GPS satellite may be interfered with by these types of communication.
- Painting the GPS antenna with (metallic) paint may cause a drop in performance.

Connection/Installation

Microphone unit

- 1) Check the installation position of the microphone (accessory ④).
- 2) Clean the installation surface.
- 3) Remove the separator of the microphone (accessory ④), and stick the microphone to the place shown below.
- 4) Wire the microphone cable up to the unit with it secured at several positions using tape or other desired method.
- 5) Adjust the direction of the microphone (accessory ④) to the driver.

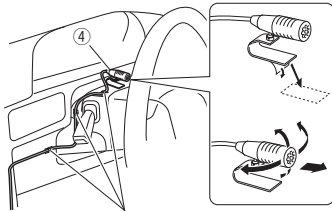

Fix a cable with a commercial item of tape.

Removing the trim plate

- 1) Engage the catch pins on the extraction key (accessory ⑤) and remove the two locks on the lower level.
Lower the trim plate (accessory ⑧) and pull it forward as shown in the figure.

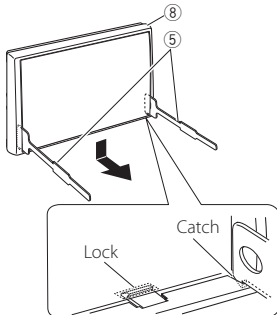

NOTE

- The trim plate can be removed from the top side in the same manner.

- 2) When the lower level is removed, remove the upper two locations.

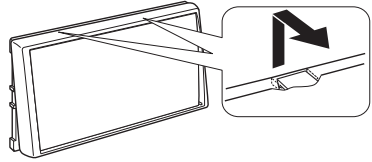

Removing the unit

- 1) Remove the trim plate. (P.24)
- 2) Insert the two extraction key (accessory ⑤) deeply into the slots on each side, as shown.

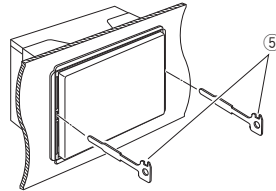

- 3) Lower the extraction key toward the bottom, and pull out the unit halfway while pressing towards the inside.

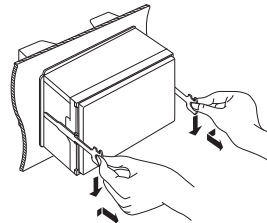

NOTE

- Be careful to avoid injury from the catch pins on the extraction key.

- 4) Pull the unit all the way out with your hands, being careful not to drop it.

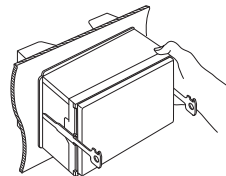

Connecting wires to terminals

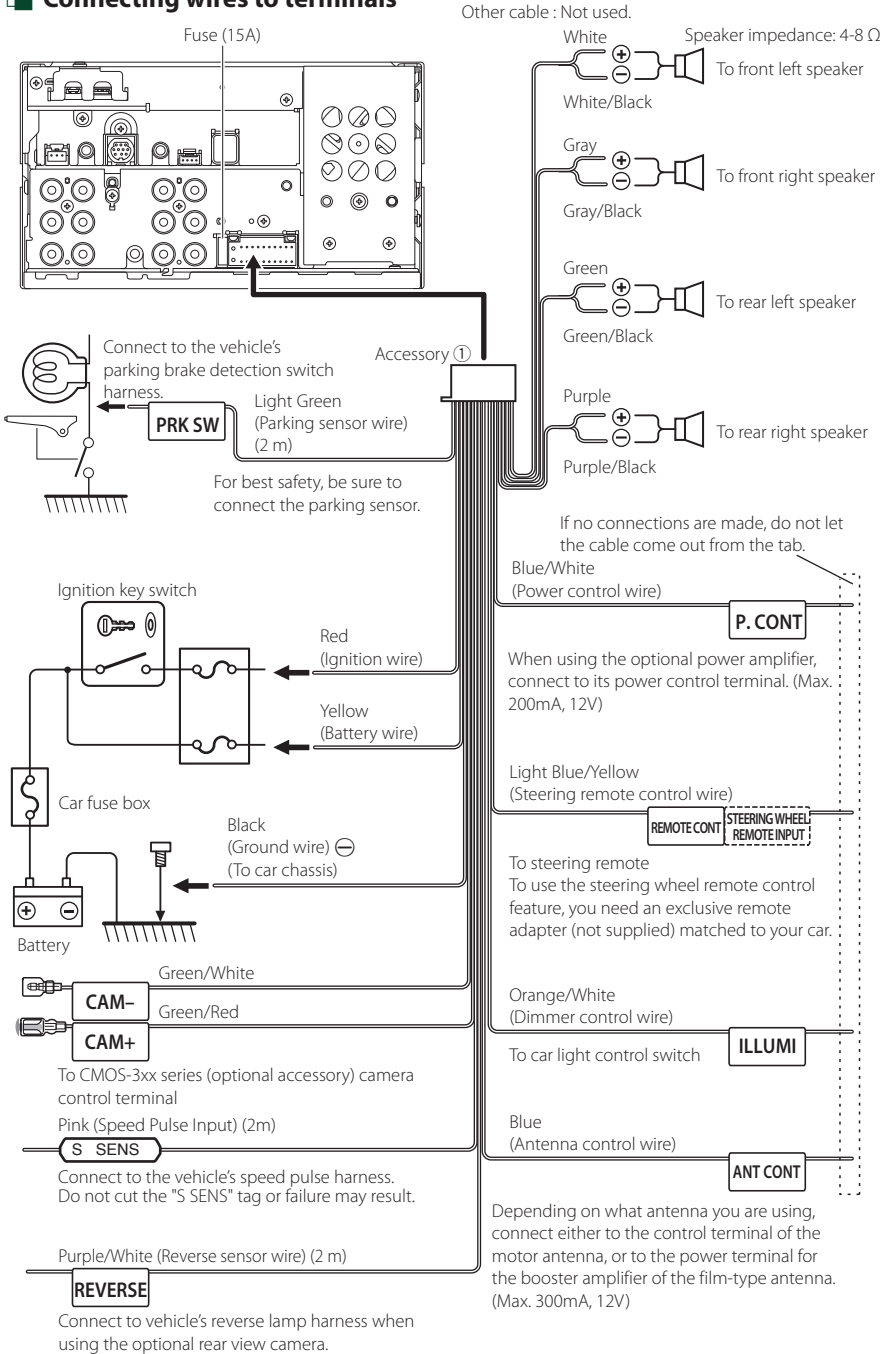

3-way speaker system setup

● DMX958XR / DMX908S

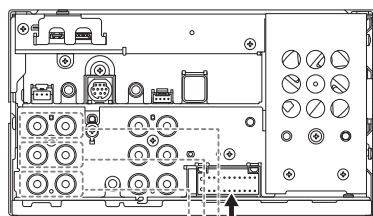

Subwoofer Preout
Mid Range Preout
Tweeter Preout

When connecting to an external amplifier, connect its ground wire to the car's chassis to avoid damaging the unit.

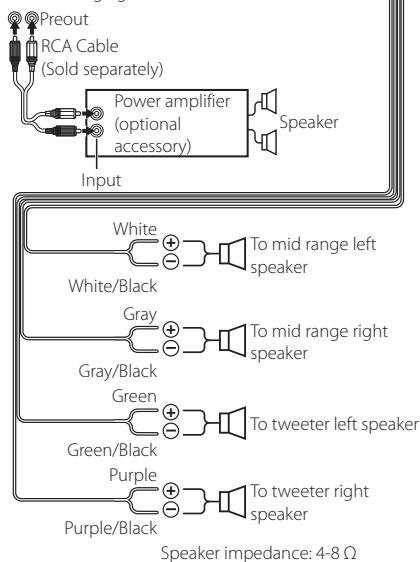

NOTE

- For speaker system setup, see **3-way speaker system setup (P.75)** in the Instruction Manual.
- For speaker setup and crossover setup, see **Speaker / X'over setup (P.76)** in the Instruction Manual.
- For how to connect speaker wires to terminals other than speaker terminals and Preout terminals, see **Connecting the system and external components (P.26)** and **Connecting wires to terminals (P.25)**.

Connecting the system and external components

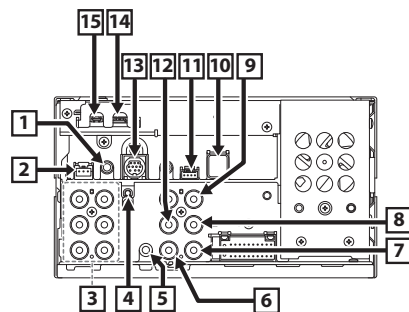

- Accessory ④: Microphone
- Dashboard camera interface
Connect a Dashboard Camera DRV-N520 (optional accessory). (P.29)
- When connecting to an external amplifier, connect its ground wire to the car's chassis to avoid damaging the unit.
- FM/AM antenna input
- AV-IN (for audio) input (ø3.5 mini jack)
- VIDEO Input (Yellow)
Connect a RCA cable (sold separately) to VIDEO input terminal to use AV-IN (for visual) or Side (Left or Right) view camera input (Yellow). For more information, see **To set up the camera assignment settings (P.30)**.
- Front view camera/Dashboard camera input (Yellow).^{*1}
See **To set up the camera assignment settings (P.30)**.
- Rear view camera input (Yellow)^{*2}
- 3rd view camera input (Yellow). See **To set up the camera assignment settings (P.30)**.

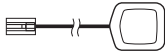
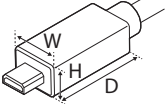
<p>10</p>	<p>Accessory ⑨: GPS Antenna Use the supplied GPS antenna. Using the GPS antenna other than the supplied one may cause a drop in positioning accuracy.</p> 
<p>11</p>	<p>iDatalink connector</p>
<p>12</p>	<p>VIDEO Output (Yellow)</p>
<p>13</p>	<p>SiriusXM Connect Vehicle Tuner connector For more information on how to install the SiriusXM Connect Vehicle tuner, consult the installation guide included with the tuner.</p>
<p>14</p>	<p>USB terminal (USB Type-C*)</p>
<p>15</p>	<p>HDMI input (Type-D) Connect a KCA-HD200 (optional accessory) to HDMI input terminal.</p>  <p>W: 11.1 mm or less H: 7.7 mm or less D: 21.5 mm or less</p>

Connecting a USB device

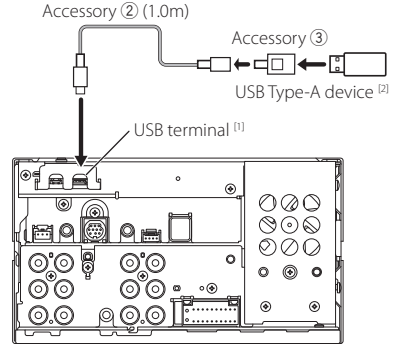

^[1] USB maximum power supply current :
DC 5 V $\overline{\text{---}}$ 3.0 A

^[2] Sold separately

*1 Connect an HD camera to Front view camera/
Dashboard camera input terminal to use HD
video. (DMX958XR only)

*2 Connect an HD camera to Rear view camera
input terminal to use HD video. (DMX958XR
only)

Installation/removal of fixing bracket

When you connect the cable to HDMI terminal
and USB terminal, remove the fixture. After
connecting the cable, put the fixture again.

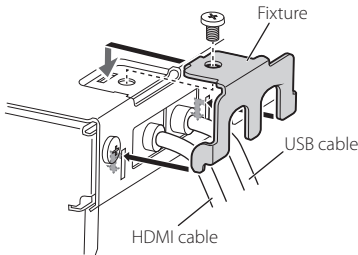

Connecting an iPod/iPhone

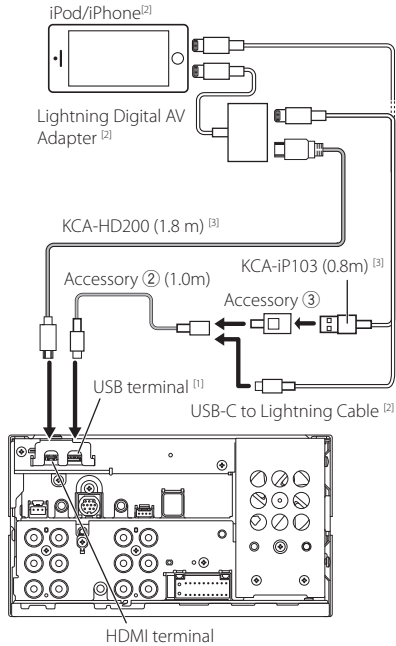

- ^[1] USB maximum power supply current : DC 5 V \equiv 3.0 A
- ^[2] Sold separately
- ^[3] Optional accessory

Connecting an Android smartphone

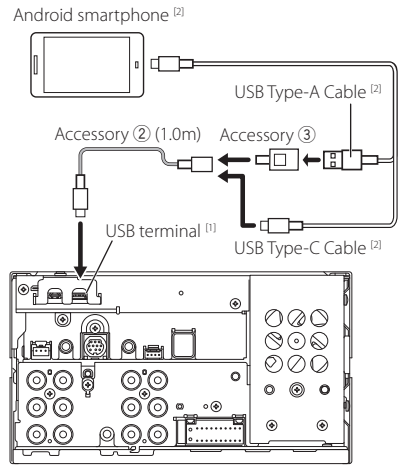

- ^[1] USB maximum power supply current : DC 5 V \equiv 3.0 A
- ^[2] Sold separately

Connecting the camera

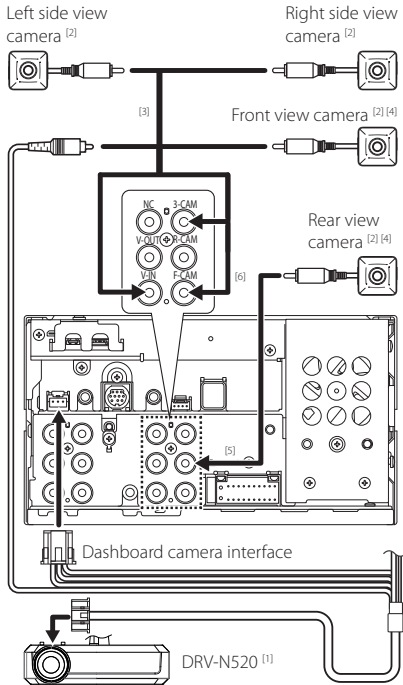

^[1] Optional accessory

^[2] Sold separately

^[3] Up to 3 cameras of Dashboard camera, Front view camera, Left side view camera and Right side view camera can be connected. **(P.30)**.

^[4] CMOS-3xx series (optional accessory) or commercially available camera.

^[5] For HD video, connect an HD camera to Rear view camera input terminal. (DMX958XR only)

^[6] For HD video, connect an HD camera to Front view camera/Dashboard camera input terminal. (DMX958XR only)

To set up the camera assignment settings

- 1 Press the **MENU** button.
 - Popup menu appears.
- 2 Touch **SETUP**.
 - SETUP Menu screen appears.
- 3 Touch **Camera**.
 - Camera screen appears.
- 4 Touch **Camera Assignment Settings**.
- 5 Select the item to set up.

■ **REAR VIEW CAMERA (DMX958XR)**
 Change the HD camera picture quality setting when an HD camera is connected with this unit.

■ **FRONT VIEW CAMERA / DASH CAM**
 Set the camera assignment from view camera connected to Front view camera/ Dashboard camera input terminal.
 Change the HD camera picture quality setting when an HD camera is connected. (DMX958XR)

■ **3rd VIEW CAMERA**
 Set the camera assignment from view camera connected to 3rd view camera input terminal.

■ **AV-IN**
 Set the camera assignment from view camera connected to VIDEO input terminal.

6 Select the view camera to set up.

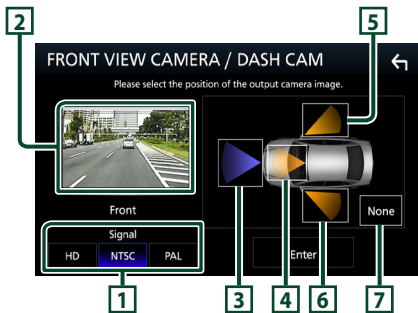

1 Picture quality settings (DMX958XR) *1

2 Picture from view camera

3 Front *2

4 Dashboard Camera *2

5 Right *2

6 Left *2

7 None *2

*1 The **REAR VIEW CAMERA** and **FRONT VIEW CAMERA / DASH CAM** setting screens only when HD camera is connected.

*2 Except the **REAR VIEW CAMERA** setting screen.

7 Touch Enter.

Appendix

Note for specifications

■ **Bluetooth section**

Frequency : 2.402 – 2.480 GHz

■ **General**

Operating Voltage : 12 V DC car battery

Speaker Impedance : 4 – 8 Ω

■ Copyrights

- The Bluetooth® word mark and logos are registered trademarks owned by Bluetooth SIG, Inc. and any use of such marks by JVC/KENWOOD Corporation is under license. Other trademarks and trade names are those of their respective owners.
- USB Type-C® and USB-C® are registered trademarks of USB Implementers Forum.
- LDAC™ and LDAC logo are trademarks of Sony Corporation.
- Hi-Res Audio logo and Hi-Res Audio Wireless logo are used under license from Japan Audio Society.



- Windows Media is a registered trademark or trademark of Microsoft Corporation in the United States and/or other countries.
This product is protected by certain intellectual property rights of Microsoft. Use or distribution of such technology outside of this product is prohibited without a license from Microsoft.
- This software is based in part on the work of the independent JPEG Group.
- Use of the Made for Apple badge means that an accessory has been designed to connect specifically to the Apple product(s) identified in the badge and has been certified by the developer to meet Apple performance standards. Apple is not responsible for the operation of this device or its compliance with safety and regulatory standards. Please note that the use of this accessory with an Apple product may affect wireless performance.
- Apple, iPhone, iPod, iPod touch, and Lightning are trademarks of Apple Inc., registered in the U.S. and other countries.
- Apple, Siri, Apple CarPlay, Apple Music and Apple CarPlay logo are trademarks of Apple Inc., registered in the U.S. and other countries.
- App Store is a service mark of Apple Inc., registered in the U.S. and other countries.
- iOS is a trademark or registered trademark of Cisco in the U.S. and other countries and is used under license.
- SiriusXM and all related marks and logos are trademarks of Sirius XM Radio, Inc. All rights reserved.
- HD Radio Technology manufactured under license from iBiquity Digital Corporation. U.S. and Foreign Patents. For patents see <https://dts.com/patents>. HD Radio and the HD, HD Radio, and "ARC" logos are registered trademarks or trademarks of iBiquity Digital Corporation in the United States and/or other countries.
- INRIX is a registered trademark of INRIX, Inc.
- Google, Android, Google Play and Android Auto are trademarks of Google LLC.

- To use Android Auto on your car display, you'll need an Android Auto compatible vehicle or aftermarket stereo, an Android phone running Android 6 or higher, and the Android Auto app.
- Wi-Fi® is a registered trademark of Wi-Fi Alliance®.
- The Wi-Fi CERTIFIED™ Logo is a certification mark of Wi-Fi Alliance®.
- Copyright© 2018 Techpoint, Inc. All rights reserved.

HD-TVI™

- The terms HDMI, HDMI High-Definition Multimedia Interface, and the HDMI Logo are trademarks or registered trademarks of HDMI Licensing Administrator, Inc.
- Linux® is the registered trademark of Linus Torvalds in the U.S. and other countries.
- This product includes FontAvenue® fonts licenced by NEC Corporation. FontAvenue is a registered trademark of NEC Corporation.

FontAvenue

- This product includes "Ubiquitous QuickBoot™" technology developed by Ubiquitous AI Corporation. Ubiquitous QuickBoot™ is a trademark of Ubiquitous AI Corporation.
Copyright© 2021 Ubiquitous AI Corporation All rights reserved.



- THIS PRODUCT IS LICENSED UNDER THE AVC PATENT PORTFOLIO LICENSE FOR THE PERSONAL USE OF A CONSUMER OR OTHER USES IN WHICH IT DOES NOT RECEIVE REMUNERATION TO (i) ENCODE VIDEO IN COMPLIANCE WITH THE AVC STANDARD ("AVC VIDEO") AND/OR (ii) DECODE AVC VIDEO THAT WAS ENCODED BY A CONSUMER ENGAGED IN A PERSONAL ACTIVITY AND/OR WAS OBTAINED FROM A VIDEO PROVIDER LICENSED TO PROVIDE AVC VIDEO. NO LICENSE IS GRANTED OR SHALL BE IMPLIED FOR ANY OTHER USE. ADDITIONAL INFORMATION MAY BE OBTAINED FROM MPEG LA, L.L.C. SEE [HTTP://WWW.MPEGLA.COM](http://www.mpegla.com)
- THIS PRODUCT IS LICENSED UNDER THE MPEG-4 VISUAL PATENT PORTFOLIO LICENSE FOR THE PERSONAL AND NON-COMMERCIAL USE OF A CONSUMER FOR (i) ENCODING VIDEO IN COMPLIANCE WITH THE MPEG-4 VISUAL STANDARD ("MPEG-4 VIDEO") AND/OR (ii) DECODING MPEG-4 VIDEO THAT WAS ENCODED BY A CONSUMER ENGAGED IN A PERSONAL AND NON-COMMERCIAL ACTIVITY AND/OR WAS OBTAINED FROM A VIDEO PROVIDER LICENSED BY MPEG LA TO PROVIDE MPEG-4 VIDEO. NO LICENSE IS GRANTED OR SHALL BE IMPLIED FOR ANY OTHER USE. ADDITIONAL INFORMATION INCLUDING THAT RELATING TO PROMOTIONAL, INTERNAL AND COMMERCIAL USES AND LICENSING MAY BE OBTAINED FROM MPEG LA, LLC. SEE [HTTP://WWW.MPEGLA.COM](http://www.mpegla.com).

Appendix

- THIS PRODUCT IS LICENSED UNDER THE VC-1 PATENT PORTFOLIO LICENSE FOR THE PERSONAL AND NON-COMMERCIAL USE OF A CONSUMER TO (i) ENCODE VIDEO IN COMPLIANCE WITH THE VC-1 STANDARD ("VC-1 VIDEO") AND/OR (ii) DECODE VC-1 VIDEO THAT WAS ENCODED BY A CONSUMER ENGAGED IN A PERSONAL AND NON-COMMERCIAL ACTIVITY AND/OR WAS OBTAINED FROM A VIDEO PROVIDER LICENSED TO PROVIDE VC-1 VIDEO. NO LICENSE IS GRANTED OR SHALL BE IMPLIED FOR ANY OTHER USE. ADDITIONAL INFORMATION MAY BE OBTAINED FROM MPEG LA, L.L.C. SEE [HTTP://WWW.MPEGLA.COM](http://www.mpegla.com)
- libFLAC
Copyright (C) 2000-2009 Josh Coalson
Copyright (C) 2011-2013 Xiph.Org Foundation
Redistribution and use in source and binary forms, with or without modification, are permitted provided that the following conditions are met:
 - Redistributions of source code must retain the above copyright notice, this list of conditions and the following disclaimer.
 - Redistributions in binary form must reproduce the above copyright notice, this list of conditions and the following disclaimer in the documentation and/or other materials provided with the distribution.
 - Neither the name of the Xiph.org Foundation nor the names of its contributors may be used to endorse or promote products derived from this software without specific prior written permission. THIS SOFTWARE IS PROVIDED BY THE COPYRIGHT HOLDERS AND CONTRIBUTORS "AS IS" AND ANY EXPRESS OR IMPLIED WARRANTIES, INCLUDING, BUT NOT LIMITED TO, THE IMPLIED WARRANTIES OF MERCHANTABILITY AND FITNESS FOR A PARTICULAR PURPOSE ARE DISCLAIMED. IN NO EVENT SHALL THE FOUNDATION OR CONTRIBUTORS BE LIABLE FOR ANY DIRECT, INDIRECT, INCIDENTAL, SPECIAL, EXEMPLARY, OR CONSEQUENTIAL DAMAGES (INCLUDING, BUT NOT LIMITED TO, PROCUREMENT OF SUBSTITUTE GOODS OR SERVICES; LOSS OF USE, DATA, OR PROFITS; OR BUSINESS INTERRUPTION) HOWEVER CAUSED AND ON ANY THEORY OF LIABILITY, WHETHER IN CONTRACT, STRICT LIABILITY, OR TORT (INCLUDING NEGLIGENCE OR OTHERWISE) ARISING IN ANY WAY OUT OF THE USE OF THIS SOFTWARE, EVEN IF ADVISED OF THE POSSIBILITY OF SUCH DAMAGE.
- libvorbis
Copyright (c) 2002-2008 Xiph.org Foundation
Redistribution and use in source and binary forms, with or without modification, are permitted provided that the following conditions are met:
 - Redistributions of source code must retain the above copyright notice, this list of conditions and the following disclaimer.
 - Redistributions in binary form must reproduce the above copyright notice, this list of conditions and the following disclaimer in the documentation and/or other materials provided with the distribution.
- Neither the name of the Xiph.org Foundation nor the names of its contributors may be used to endorse or promote products derived from this software without specific prior written permission. THIS SOFTWARE IS PROVIDED BY THE COPYRIGHT HOLDERS AND CONTRIBUTORS "AS IS" AND ANY EXPRESS OR IMPLIED WARRANTIES, INCLUDING, BUT NOT LIMITED TO, THE IMPLIED WARRANTIES OF MERCHANTABILITY AND FITNESS FOR A PARTICULAR PURPOSE ARE DISCLAIMED. IN NO EVENT SHALL THE FOUNDATION OR CONTRIBUTORS BE LIABLE FOR ANY DIRECT, INDIRECT, INCIDENTAL, SPECIAL, EXEMPLARY, OR CONSEQUENTIAL DAMAGES (INCLUDING, BUT NOT LIMITED TO, PROCUREMENT OF SUBSTITUTE GOODS OR SERVICES; LOSS OF USE, DATA, OR PROFITS; OR BUSINESS INTERRUPTION) HOWEVER CAUSED AND ON ANY THEORY OF LIABILITY, WHETHER IN CONTRACT, STRICT LIABILITY, OR TORT (INCLUDING NEGLIGENCE OR OTHERWISE) ARISING IN ANY WAY OUT OF THE USE OF THIS SOFTWARE, EVEN IF ADVISED OF THE POSSIBILITY OF SUCH DAMAGE.
- libogg
Copyright (c) 2002, Xiph.org Foundation
Redistribution and use in source and binary forms, with or without modification, are permitted provided that the following conditions are met:
 - Redistributions of source code must retain the above copyright notice, this list of conditions and the following disclaimer.
 - Redistributions in binary form must reproduce the above copyright notice, this list of conditions and the following disclaimer in the documentation and/or other materials provided with the distribution.
 - Neither the name of the Xiph.org Foundation nor the names of its contributors may be used to endorse or promote products derived from this software without specific prior written permission. THIS SOFTWARE IS PROVIDED BY THE COPYRIGHT HOLDERS AND CONTRIBUTORS "AS IS" AND ANY EXPRESS OR IMPLIED WARRANTIES, INCLUDING, BUT NOT LIMITED TO, THE IMPLIED WARRANTIES OF MERCHANTABILITY AND FITNESS FOR A PARTICULAR PURPOSE ARE DISCLAIMED. IN NO EVENT SHALL THE FOUNDATION OR CONTRIBUTORS BE LIABLE FOR ANY DIRECT, INDIRECT, INCIDENTAL, SPECIAL, EXEMPLARY, OR CONSEQUENTIAL DAMAGES (INCLUDING, BUT NOT LIMITED TO, PROCUREMENT OF SUBSTITUTE GOODS OR SERVICES; LOSS OF USE, DATA, OR PROFITS; OR BUSINESS INTERRUPTION) HOWEVER CAUSED AND ON ANY THEORY OF LIABILITY, WHETHER IN CONTRACT, STRICT LIABILITY, OR TORT (INCLUDING NEGLIGENCE OR OTHERWISE) ARISING IN ANY WAY OUT OF THE USE OF THIS SOFTWARE, EVEN IF ADVISED OF THE POSSIBILITY OF SUCH DAMAGE.

Apéndice

- THIS PRODUCT IS LICENSED UNDER THE VC-1 PATENT PORTFOLIO LICENSE FOR THE PERSONAL AND NON-COMMERCIAL USE OF A CONSUMER TO (i) ENCODE VIDEO IN COMPLIANCE WITH THE VC-1 STANDARD ("VC-1 VIDEO") AND/OR (ii) DECODE VC-1 VIDEO THAT WAS ENCODED BY A CONSUMER ENGAGED IN A PERSONAL AND NON-COMMERCIAL ACTIVITY AND/OR WAS OBTAINED FROM A VIDEO PROVIDER LICENSED TO PROVIDE VC-1 VIDEO. NO LICENSE IS GRANTED OR SHALL BE IMPLIED FOR ANY OTHER USE. ADDITIONAL INFORMATION MAY BE OBTAINED FROM MPEG LA, L.L.C. SEE [HTTP://WWW.MPEGLA.COM](http://www.mpegla.com)
- libFLAC
Copyright (C) 2000-2009 Josh Coalson
Copyright (C) 2011-2013 Xiph.Org Foundation
Redistribution and use in source and binary forms, with or without modification, are permitted provided that the following conditions are met:
 - Redistributions of source code must retain the above copyright notice, this list of conditions and the following disclaimer.
 - Redistributions in binary form must reproduce the above copyright notice, this list of conditions and the following disclaimer in the documentation and/or other materials provided with the distribution.
 - Neither the name of the Xiph.org Foundation nor the names of its contributors may be used to endorse or promote products derived from this software without specific prior written permission. THIS SOFTWARE IS PROVIDED BY THE COPYRIGHT HOLDERS AND CONTRIBUTORS "AS IS" AND ANY EXPRESS OR IMPLIED WARRANTIES, INCLUDING, BUT NOT LIMITED TO, THE IMPLIED WARRANTIES OF MERCHANTABILITY AND FITNESS FOR A PARTICULAR PURPOSE ARE DISCLAIMED. IN NO EVENT SHALL THE FOUNDATION OR CONTRIBUTORS BE LIABLE FOR ANY DIRECT, INDIRECT, INCIDENTAL, SPECIAL, EXEMPLARY, OR CONSEQUENTIAL DAMAGES (INCLUDING, BUT NOT LIMITED TO, PROCUREMENT OF SUBSTITUTE GOODS OR SERVICES; LOSS OF USE, DATA, OR PROFITS; OR BUSINESS INTERRUPTION) HOWEVER CAUSED AND ON ANY THEORY OF LIABILITY, WHETHER IN CONTRACT, STRICT LIABILITY, OR TORT (INCLUDING NEGLIGENCE OR OTHERWISE) ARISING IN ANY WAY OUT OF THE USE OF THIS SOFTWARE, EVEN IF ADVISED OF THE POSSIBILITY OF SUCH DAMAGE.
- libvorbis
Copyright (c) 2002-2008 Xiph.org Foundation
Redistribution and use in source and binary forms, with or without modification, are permitted provided that the following conditions are met:
 - Redistributions of source code must retain the above copyright notice, this list of conditions and the following disclaimer.
 - Redistributions in binary form must reproduce the above copyright notice, this list of conditions and the following disclaimer in the documentation and/or other materials provided with the distribution.
- Neither the name of the Xiph.org Foundation nor the names of its contributors may be used to endorse or promote products derived from this software without specific prior written permission. THIS SOFTWARE IS PROVIDED BY THE COPYRIGHT HOLDERS AND CONTRIBUTORS "AS IS" AND ANY EXPRESS OR IMPLIED WARRANTIES, INCLUDING, BUT NOT LIMITED TO, THE IMPLIED WARRANTIES OF MERCHANTABILITY AND FITNESS FOR A PARTICULAR PURPOSE ARE DISCLAIMED. IN NO EVENT SHALL THE FOUNDATION OR CONTRIBUTORS BE LIABLE FOR ANY DIRECT, INDIRECT, INCIDENTAL, SPECIAL, EXEMPLARY, OR CONSEQUENTIAL DAMAGES (INCLUDING, BUT NOT LIMITED TO, PROCUREMENT OF SUBSTITUTE GOODS OR SERVICES; LOSS OF USE, DATA, OR PROFITS; OR BUSINESS INTERRUPTION) HOWEVER CAUSED AND ON ANY THEORY OF LIABILITY, WHETHER IN CONTRACT, STRICT LIABILITY, OR TORT (INCLUDING NEGLIGENCE OR OTHERWISE) ARISING IN ANY WAY OUT OF THE USE OF THIS SOFTWARE, EVEN IF ADVISED OF THE POSSIBILITY OF SUCH DAMAGE.
- libogg
Copyright (c) 2002, Xiph.org Foundation
Redistribution and use in source and binary forms, with or without modification, are permitted provided that the following conditions are met:
 - Redistributions of source code must retain the above copyright notice, this list of conditions and the following disclaimer.
 - Redistributions in binary form must reproduce the above copyright notice, this list of conditions and the following disclaimer in the documentation and/or other materials provided with the distribution.
 - Neither the name of the Xiph.org Foundation nor the names of its contributors may be used to endorse or promote products derived from this software without specific prior written permission. THIS SOFTWARE IS PROVIDED BY THE COPYRIGHT HOLDERS AND CONTRIBUTORS "AS IS" AND ANY EXPRESS OR IMPLIED WARRANTIES, INCLUDING, BUT NOT LIMITED TO, THE IMPLIED WARRANTIES OF MERCHANTABILITY AND FITNESS FOR A PARTICULAR PURPOSE ARE DISCLAIMED. IN NO EVENT SHALL THE FOUNDATION OR CONTRIBUTORS BE LIABLE FOR ANY DIRECT, INDIRECT, INCIDENTAL, SPECIAL, EXEMPLARY, OR CONSEQUENTIAL DAMAGES (INCLUDING, BUT NOT LIMITED TO, PROCUREMENT OF SUBSTITUTE GOODS OR SERVICES; LOSS OF USE, DATA, OR PROFITS; OR BUSINESS INTERRUPTION) HOWEVER CAUSED AND ON ANY THEORY OF LIABILITY, WHETHER IN CONTRACT, STRICT LIABILITY, OR TORT (INCLUDING NEGLIGENCE OR OTHERWISE) ARISING IN ANY WAY OUT OF THE USE OF THIS SOFTWARE, EVEN IF ADVISED OF THE POSSIBILITY OF SUCH DAMAGE.

■ FCC CAUTION

Changes or modifications not expressly approved by the party responsible for compliance could void the user's authority to operate the equipment.

NOTE

- This equipment has been tested and found to comply with the limits for a Class B digital device, pursuant to part 15 of the FCC Rules. These limits are designed to provide reasonable protection against harmful interference in a residential installation.
- This equipment generates, uses and can radiate radio frequency energy and, if not installed and used in accordance with the instructions, may cause harmful interference to radio communications. However, there is no guarantee that interference will not occur in a particular installation. If this equipment does cause harmful interference to radio or television reception, which can be determined by turning the equipment off and on, the user is encouraged to try to correct the interference by one or more of the following measures:
 - Reorient or relocate the receiving antenna.
 - Increase the separation between the equipment and receiver.
 - Connect the equipment into an outlet on a circuit different from that to which the receiver is connected.
 - Consult the dealer or an experienced radio/TV technician for help.

This transmitter must not be co-located or operated in conjunction with any other antenna or transmitter.

■ ISED CAUTION

This device contains licence-exempt transmitter(s)/ receiver(s) that comply with Innovation, Science and Economic Development Canada's licence-exempt RSS(s).

Operation is subject to the following two conditions:

- (1) This device may not cause interference.
- (2) This device must accept any interference, including interference that may cause undesired operation of the device.

▲ CAUTION

This equipment complies with FCC/ISED radiation exposure limits set forth for an uncontrolled environment and meets the FCC radio frequency (RF) Exposure Guidelines and RSS-102 of the ISED radio frequency (RF) Exposure rules. This equipment should be installed and operated keeping the radiator at least 20cm or more away from person's body.

■ Attention de l'ISED

L'émetteur/récepteur exempt de licence contenu dans le présent appareil est conforme aux CNR d'Innovation, Sciences et Développement économique Canada applicables aux appareils radio exempts de licence. L'exploitation est autorisée aux deux conditions suivantes :

- (1) L'appareil ne doit pas produire de brouillage.
- (2) L'appareil doit accepter tout brouillage radioélectrique subi, même si le brouillage est susceptible d'en compromettre le fonctionnement.

▲ ATTENTION

Cet équipement est conforme aux limites d'exposition aux rayonnements énoncées pour un environnement non contrôlé et respecte les règles des radioélectriques (RF) de la FCC lignes directrices d'exposition et d'exposition aux fréquences radioélectriques (RF) CNR-102 de l'ISED. Cet équipement doit être installé et utilisé en gardant une distance de 20 cm ou plus entre le radiateur et le corps humain.

Supplier's Declaration of Conformity

Trade Name: KENWOOD
Products: MONITOR WITH RECEIVER
Model Name: DMX958XR / DMX908S /
DMX9708S
Responsible Party: JVCKENWOOD USA
CORPORATION
4001 Worsham Avenue,
Long Beach, CA 90808, U.S.A.
PHONE: 1-800-252-5722

THIS DEVICE COMPLIES WITH PART 15 OF THE FCC
RULES. OPERATION IS SUBJECT TO THE FOLLOWING
TWO CONDITIONS:

- (1) THIS DEVICE MAY NOT CAUSE HARMFUL
INTERFERENCE, AND
- (2) THIS DEVICE MUST ACCEPT ANY INTERFERENCE
RECEIVED, INCLUDING INTERFERENCE THAT MAY
CAUSE UNDESIRED OPERATION.

■ Información acerca de la eliminación de equipos eléctricos y electrónicos al final de la vida útil (aplicable a los países que hayan adoptado sistemas independientes de recogida de residuos)



Los productos con el símbolo de un contenedor con
ruedas tachado no podrán ser desechados como
residuos domésticos.

Los equipos eléctricos y electrónicos al final de la vida
útil, deberán ser reciclados en instalaciones que puedan
dar el tratamiento adecuado a estos productos y a sus
subproductos residuales correspondientes. Póngase
en contacto con su administración local para obtener
información sobre el punto de recogida más cercano.
Un tratamiento correcto del reciclaje y la eliminación
de residuos ayuda a conservar los recursos y evita al
mismo tiempo efectos perjudiciales en la salud y el
medio ambiente.

■ Informação sobre a eliminação de pilhas

Este produto não deve ser eliminado como lixo
doméstico geral. Devolva a pilha usada ao revendedor
ou entidade autorizada para que a mesma seja
devolvida ao fabricante ou importador.

A reciclagem e a eliminação de lixo de maneira
apropriada ajudarão a conservar os recursos naturais ao
mesmo tempo que prevenirão os efeitos prejudiciais à
nossa saúde e ao meio ambiente.

■ Para cumplimiento de la IFT:

La operación de este equipo esta sujeta a las
siguientes dos condiciones:

- (1) es posible que este equipo o dispositivo no
cause interferencia perjudicial y
- (2) este equipo o dispositivo debe aceptar
cualquier interferencia,

incluyendo la que pueda causar su operación no
deseada.

android
auto

(((SiriusXM)))
READY

Made for
iPhone | iPod

Works with
Apple CarPlay



Hi-Res Audio logo and Hi-Res Audio
Wireless logo are used under license
from Japan Audio Society.



HD Radio®
This HD Radio receiver enables:

- HD2/HD3
- Bookmark
- Digital Sound
- Program Info
- Artist Experience
- Emergency Alerts

KENWOOD

MILITARY

Units purchased through the U.S.A. military exchange service overseas may be serviced under warranty in the continental U.S.A., subject to the following conditions.

- 1) The original warranty is in effect.
- 2) Proof of purchase is provided to the servicer.

WARRANTY FOR MILITARY MARKET

JVC KENWOOD corporation is proud of the quality and workmanship of its audio equipment. This unit has been properly designed, tested and inspected before it was shipped to you. If properly installed and operated in accordance with instructions furnished, it should give you an optimum reliable performance.

WARRANTY PERIOD

This product is warranted for a period of (1) year from the date of the original purchase.

SCOPE OF WARRANTY

Except as specified below, this warranty covers all defects in materials and workmanship of the Kenwood brand products.

During the warranty period, any authorized Kenwood Service Center in the military market listed in the back of this warranty card will provide you free-of-charge both parts and labor required to correct any defect in materials or workmanship.

The following are not covered by this warranty.

1. Voltage conversions.
2. Periodic check-ups which do not disclose any defect covered by the warranty.
3. Cabinets, grilles, other exterior finishes, belts, tape heads, and other non-durable parts and accessories.
4. Units on which the serial number has been effaced, modified or removed.
5. Installation and/or removal charges.
6. Damaged magnetic tapes.
7. House call charges for any repairs.
8. Shipping or delivery charges to or from an authorized Kenwood Service Center.
9. This warranty will not cover any failure that is due to any of the following conditions in accordance with the visual inspection of the authorized Kenwood Service Center:
 - * Improper maintenance or repair, including the installation of parts or accessories that do not conform to the quality and specifications of the original parts.
 - * Misuse, abuse, neglect, unauthorized product modification or failure to follow instructions contained in the Owner's Manual.
 - * Accidental or intentional damages.
 - * Repairs or attempted repairs by an unauthorized agency. (All repairs must be performed at an authorized Kenwood Service Center.)
 - * Damages or deteriorations caused during shipment (Claims must be presented to the carrier).
 - * Damages or deteriorations resulting from removal and/or replacement.

PURCHASER'S RESPONSIBILITIES

As the purchaser of a new Kenwood brand product, you are requested to do the following in order to obtain Kenwood warranty service.

1. Retain your sales slip or other evidence of purchase for proving your eligibility for requesting Kenwood warranty service.
2. Make your unit available to an authorized Kenwood Service Center in the military market for inspection and approved warranty service, or ship your unit in its original carton box or equivalent, fully insured and shipping charges prepaid, to the authorized Kenwood Service Center.

LIMITATION OF IMPLIED WARRANTIES

Any and all implied warranties, including warranties of merchantability and fitness for a particular purpose, shall be limited in duration to the length of this warranty.

EXCLUSION OF CERTAIN DAMAGES

KENWOOD'S liability for any defective product is limited to the repair or replacement of said product, at our option, and shall not include damages of any kind, whether incidental, consequential or otherwise, except to the extent prohibited by applicable law.

KENWOOD AUTHORIZED SERVICE CENTERS IN MILITARY MARKET

JAPAN:

Yokota
Kenwood Rep.; c/o
Yokota BX, JAAX AAFES-PAC,
APO San Francisco 96328

Zama

Kenwood Rep.; c/o
Zama PX, JAAX AAFES-PAC,
APO San Francisco 96343

Misawa

Kenwood Rep.; c/o
Misawa BX, JAAX AAFES-PAC,
APO San Francisco 96519

Yokosuka

Kenwood Rep.; c/o
A-33, Yokosuka NEX No. 260-010
FPO Seattle 98760

Atsugi

Kenwood Rep.; c/o
Atsugi NEX No. 260-020 FPO Seattle
98767

Iwakuni

Kenwood Rep.; c/o
Marine Corps Exchange, Marine Corps
Air Station,
FPO Seattle 98764

Sasebo

Sasebo NEX;
Navy Exchange 260-040
F.A. Box 115 FPO Seattle 98766

Okinawa

Kenwood Rep.; c/o
OWAX, AAFES-PAC, APO San Francisco
96230

KOREA:

Kenwood Rep.; c/o
KOAX Repair Shop, AAFES-PAC
DD-Camp Market, APO San Francisco
96488

GUAM:

Kenwood Rep.; c/o
Guam NEX No. 230-010,
FPO San Francisco 96630
Kenwood Rep.; c/o
GUAX, AAFES-PAC, APO San Francisco
96334

U.S.A.:

In The Continental U.S.A.
For Nearest Authorized Service Center;
Tel: 1-800-536-9663
www.us.jvckenwood.com

EUROPE:

Please inquire at the military resale outlets where you bought your Kenwood products, or JVKENWOOD DEUTSCHLAND GMBH: Konrad-Adenauer Allee 1-11, 61118 Bad Vilbel, Germany

Warranty Card

Identificação do produto
Modelo do aparelho e número de série
Model number & serial number

Revendeur & cachet
Nome da loja e carimbo
Dealer & stamp

Date d'achat
Data da compra
Purchase date

Norm & adresse du client
Nome e endereço do cliente
Name & address of customer

Attention:

This card and receipt (or invoice) are necessary to purchase a new panel in case of theft or damage.

Attention:

Vous aurez besoin de cette carte et du reçu (ou de la facture) pour acheter un nouveau panneau en cas de vol ou d'endommagement.

Atenção:

Em caso de dano ou perda do painel frontal, este Certificado de Garantia e a Nota Fiscal de compra serão requisitados para a aquisição de um novo painel.

© B46-0824-00/04 (K) (15/11)

KENWOOD

Dear Customer,

Thank you for purchasing this Kenwood product. As mentioned in the pages of this booklet, our warranty is only valid in the countries listed. If your country is not listed please contact your retailer for information on warranty procedure, or write to:

JVC KENWOOD Customer Information Center

3-12, Moriyacho, Kanagawa-ku, Yokohama-shi, Kanagawa 221-0022, Japan

U.S.A.

JVCKENWOOD USA Corporation

This warranty will be honored only in the U.S.A.

KENWOOD LIMITED WARRANTY FOR CAR STEREO COMPONENTS

HOW LONG IS THE WARRANTY
 JVCKENWOOD USA Corporation ("Kenwood") warrants this product for a period of one (1) year from the date of original purchase.

WHAT IS COVERED AND WHAT IS NOT COVERED
 Except as specified below, this warranty covers all defects in material and workmanship in Kenwood car stereo components. The following are not covered by the warranty:
 1. Any product which is not distributed in the U.S.A. by Kenwood or which is not purchased in the U.S.A. from an authorized Kenwood car stereo dealer or an automobile dealer, unless the product is purchased through the U.S.A. Military Exchange Service.
 2. Any product on which the serial number has been defaced, modified or removed.
 3. Damage, deterioration or malfunction resulting from:
 a. Any shipment of the product (claims must be presented to the carrier).
 b. Installation or removal of the product.
 c. Accident, acts of nature, misuse, abuse, neglect, unauthorized product modification or failure to follow instructions supplied with the product.
 d. Repair or attempted repair by anyone not authorized by Kenwood.
 e. Any other cause which does not relate to a product defect.

WHO IS PROTECTED
 This warranty is enforceable only by the original purchaser.

WHAT WE WILL PAY FOR
 We will pay for all labor and material expenses for covered items. Payment of shipping charges is discussed in the next section of this warranty.

HOW TO OBTAIN WARRANTY SERVICE
 If your KENWOOD product ever needs service:
 1. Take or ship it to any KENWOOD Authorized Service Center in the U.S.A. along with a complete description of the problem. (If you are uncertain as to whether a Service Center is authorized, please call 1-800-KENWOOD for the nearest Service Center. 1-800-536-9663).
 2. Although you must pay any shipping charges if it is necessary to ship the product for warranty service, we will pay the return shipping charges if the repairs are covered by the warranty within the United States.
 3. Whenever your units are taken or sent for warranty service, you must include a copy of the original dated sales receipt as proof of warranty coverage.

LIMITATION OF IMPLIED WARRANTIES
 ALL IMPLIED WARRANTIES, INCLUDING WARRANTIES OF MERCHANTABILITY AND FITNESS FOR A PARTICULAR PURPOSE, ARE LIMITED IN DURATION TO THE LENGTH OF THIS WARRANTY.

EXCLUSION OF DAMAGES
 KENWOOD'S LIABILITY FOR ANY DEFECTIVE PRODUCT IS LIMITED TO THE REPAIR OR REPLACEMENT OF THE PRODUCT AT OUR OPTION. KENWOOD SHALL NOT BE LIABLE FOR:
 1. INSTALLATION OR REMOVAL CHARGES, DAMAGE TO OTHER PROPERTY CAUSED BY ANY DEFECTS IN KENWOOD CAR STEREO COMPONENTS, DAMAGES BASED UPON INCONVENIENCE, LOSS OF USE OF THE PRODUCT, OR
 2. ANY OTHER DAMAGES, WHETHER INCIDENTAL, CONSEQUENTIAL OR OTHERWISE.
 SOME STATES DO NOT ALLOW LIMITATIONS ON HOW LONG AN IMPLIED WARRANTY LASTS AND/OR DO NOT ALLOW THE EXCLUSION OR LIMITATION OF INCIDENTAL OR CONSEQUENTIAL DAMAGES, SO THE ABOVE LIMITATIONS AND EXCLUSIONS MAY NOT APPLY TO YOU.

This warranty gives you specific legal rights, and you may also have other rights which vary from state to state.

If a problem develops during or after the Limited Warranty Period, or if you have any questions regarding the operation of the product, you should contact your KENWOOD Authorized Dealer or Authorized Service Center. If the problem or your question is not handled to your satisfaction, please contact our Customer Relations Department at the address listed below:

JVCKENWOOD USA Corporation
PO Box 22745, 2201 E. Dominguez St.
Long Beach, CA 90810-5745
Tel: (800) 536-9663
www.us.jvckenwood.com

BRASIL

JVC KENWOOD DO BRASIL COMÉRCIO DE ELETRÔNICOS LTDA

O fabricante garante o produto identificado na Nota Fiscal de venda ao consumidor contra qualquer defeito de fabricação ou de matéria-prima durante o período de garantia. Esta garantia é válida no território brasileiro desde que o produto tenha sido adquirido no Brasil e distribuído pela JVC KENWOOD do Brasil Comércio de Eletrônicos Ltda.

PERÍODO DE GARANTIA
 Este produto é garantido pelo prazo de 01 (um) ano, incluindo o período estabelecido por lei, a partir da data de aquisição, comprovada mediante a apresentação da respectiva Nota Fiscal de venda ao consumidor final. Eventuais reparos realizados no produto durante o período de garantia não implicam na dilatação do seu prazo.

EXCLUSÃO DA GARANTIA
 (a) Produtos com o número de série ou certificado de garantia rasurados, adulterados ou ilegíveis;
 (b) Defeitos resultantes de acidentes (quedas, batidas e etc), uso em desacordo com o manual de instruções, má utilização, ligação à fonte de tensão diferente da especificada no Manual de Instruções, modificações não autorizadas;
 (c) Danos causados por agentes da natureza (Ex: chuvas, raios, maresia, enchentes e etc);
 (d) Defeitos ou danos em decorrência de consertos realizados por pessoas não autorizadas;
 (e) Defeitos ou danos resultantes do uso de peças ou dispositivos não conformes às especificações da JVC KENWOOD;
 (f) Danos ou deteriorações aos acabamentos externos, partes cosméticas, cabos, chicotes, parafusos de fixação, luvas, alças, bolsas, estojos, adaptadores, antenas, fitas, cabecas gravadoras, CDs ou danos causados por pilhas defeituosas ou com vazamento;
 (g) Defeitos ou danos devido ao transporte (reclamações devem ser feitas junto à empresa transportadora);
 (h) Qualquer outra causa que não esteja relacionada a defeitos de matéria-prima e de fabricação;
 (i) Danos causados por tentativa de roubo ou furto;
 (j) Danos causados por uso de CDs de má qualidade;
 (k) Danos decorrentes do desgaste natural do produto;
 (l) Danos causados por mau uso. (derramamento de líquidos e/ou alimentos, corrosão, oxidação, exposição à umidade ou situações climáticas extremas, riscos ou quedas).

CONCERTO EM GARANTIA
 É indispensável a apresentação deste Certificado de Garantia devidamente preenchido, acompanhado da respectiva Nota Fiscal de compra do produto, desde que não apresente rasuras ou modificações.
 O consumidor somente terá direito a estes benefícios, quando o produto for entregue diretamente no balcão de um Serviço Autorizado da JVC KENWOOD.

O QUE NÃO É COBERTO PELA GARANTIA
 Instalação e remoção do produto, despesas de frete, seguro e embalagem são de responsabilidade do proprietário.

Este produto é destinado exclusivamente ao uso doméstico.

IMPORTANTE:
 Para qualquer informação sobre seu equipamento JVC KENWOOD, ou para obter o endereço do Serviço Autorizado mais próximo, acesse o site www.kenwood.com.br, ou ligue para a Central de Atendimento JVC KENWOOD – Tel.: +55 (11) 3777-6771 com os dados abaixo preenchidos.

JVC KENWOOD DO BRASIL COMÉRCIO DE ELETRÔNICOS LTDA
Tel: (11) 3777-6771
www.kenwood.com.br

Nome do consumidor: _____

Endereço: _____ CEP: _____

Cidade: _____ Estado: _____

Telefone: _____

Data da compra: ____/____/____ Nota Fiscal: _____

CANADA

JVCKENWOOD Canada Inc.

KENWOOD WARRANTY
 JVCKENWOOD Canada Inc. (hereinafter called "KENWOOD"), gives the following written warranty to the original customer of each new Kenwood product distributed in Canada by KENWOOD and purchased from a dealer authorized by KENWOOD.

KENWOOD warrants that each new Kenwood product, under normal use, is free from any defects, subject to the terms and conditions set forth below. If a defect should occur within the warranty period, repairs will be made free of charge for parts and labour when such defects are determined by KENWOOD or its' authorized service centres to be attributable to faulty materials or workmanship at time of manufacture. Please contact KENWOOD to confirm if a dealer or service centre is authorized by KENWOOD.

WARRANTY PERIOD
 This Kenwood product is warranted for parts and labour for a period of one (1) year from the date of original purchase, lease or rental, except for products which are used in a professional or commercial application, which are warranted for a period of ninety (90) days for parts and labour and are subject to the terms and conditions of the warranty.

WARRANTY EXCLUSIONS
 This warranty excludes:
 (a) Products purchased in a foreign country or purchased in Canada and taken to a foreign country.
 (b) Products purchased from a dealer not authorized by KENWOOD.
 (c) Products with the serial number defaced, altered or missing.
 (d) Periodic check-ups which do not disclose any defects covered by this warranty.

TO OBTAIN WARRANTY SERVICE
 Should your Kenwood product require warranty service, deliver it to any authorized KENWOOD service centre and present the original copy of your bill of sale and this warranty card as proof of warranty, or send your product fully insured and freight prepaid to the nearest authorized KENWOOD service centre. To avoid possible shipping damage, make sure the product is properly packed. Include a copy of your original bill of sale and this warranty card as proof of warranty along with your name, home and /or work telephone number(s), a complete return address and a detailed description of the fault(s). Products repaired within warranty will be returned freight prepaid to destinations within Canada. The customer is responsible for all freight and related costs for the return of product(s) to destinations outside Canada.

(e) Defects resulting from disaster, accident, abuse, misuse, lightning, power surges, neglect or lack of periodic maintenance, unauthorized modification or failure to follow instructions in the owner's manual.
 (f) Defects or damage as a result of repairs performed by a person or party not authorized by KENWOOD.
 (g) Defects resulting from the use of parts or devices that do not conform to KENWOOD specifications.
 (h) Damage or deterioration occurring to any exterior finishes, cosmetic parts, tape heads, adaptors, antennas, cables, tapes, discs or faults or damage caused by defective or leaking batteries.
 (i) Defects or damage occurring during shipping (claims should be presented to the shipping company).
 (j) Product voltage and/or line frequency conversions.
 (k) Product installation or removal charges.

ENTIRE WARRANTY
 This warranty constitutes the entire written warranty given by KENWOOD. No person, party, dealer or service centre or their agents or employees are authorized to extend or enlarge this warranty on behalf of KENWOOD by any written or verbal statement or advertisement or promotion, including any extended warranty program or plan that may be offered by the dealer or service centre, unless approved in writing by KENWOOD.

DISCLAIMER
 KENWOOD disclaims any responsibility for loss of time or use of the product or any other indirect, incidental or consequential damage to other products or goods, inconvenience or commercial loss.

NOTICE TO CONSUMER
 The provisions contained in this written warranty are not intended to limit, modify, take away, disclaim or exclude any warranties or rights you may have which are set forth in any applicable provincial or federal laws or legislation.

IMPORTANT
 This warranty card by itself is not considered by KENWOOD as a valid proof of purchase. When applying for warranty repairs, you must present the original copy of your bill of sale and this warranty card as proof of warranty, so we recommend that they be kept in a safe place, should they be required in the future.

JVCKENWOOD Canada Inc.
6070 Kestrel Road, Mississauga,
Ontario, Canada L5T 1S8
Tel.: (905) 670-7211
Fax: (905) 670-7248

GARANTIE KENWOOD
 JVCKENWOOD Canada Inc. (ci-après appelée "KENWOOD"), donne par écrit la garantie suivante à l'acheteur original de chaque nouveau produit Kenwood distribué au Canada par KENWOOD et acheté à un concessionnaire autorisé par KENWOOD.

KENWOOD garantit, sous réserve des termes et des conditions énoncés ci-dessous, que chaque nouveau produit Kenwood, dans des conditions d'emploi normales, est exempt de tous défauts. Si l'un d'un défaut se produit pendant la période de garantie, KENWOOD s'engage à assumer le coût des pièces défectueuses et de la main-d'œuvre nécessaires pour effectuer les réparations pourvu que de tels défauts sont attribuables à des pièces défectueuses employées lors de la fabrication du produit Kenwood ou à la main-d'œuvre tel qu'établi par KENWOOD ou par l'un de ses centres de service autorisés. Appelez KENWOOD pour vérifier si un concessionnaire ou un centre de service est autorisé par KENWOOD.

(e) les défauts causés par les désastres, les accidents, les abus, les emplois incorrects, les éclairs, les surtensions de courant, les manques de soins ou d'entretiens périodiques, les modifications non autorisées ou les manques de respect du mode d'emploi;
 (f) les défauts ou les dommages causés lors de réparations effectuées par une personne ou par une partie non autorisée par KENWOOD;
 (g) les défauts causés par l'emploi de pièces ou de dispositifs qui ne se conforment pas aux exigences de KENWOOD;
 (h) les finitions extérieures, les pièces cosmétiques, les têtes de bandes, les adaptateurs, les antennes, les câbles, les bandes, les disques endommagés ou déperis, ni les défauts ou dommages causés par des piles défectueuses ou qui fuient;
 (i) les défauts ou dommages qui se produisent pendant l'expédition des produits Kenwood (On devrait déposer de telles réclamations auprès des compagnies de transport);
 (j) les conversions de tension et/ou de fréquence du produit;
 (k) les frais d'installation ou d'enlèvement du produit.

PÉRIODE DE GARANTIE
 Les pièces et la main-d'œuvre nécessaires pour la réparation des produits Kenwood sont garanties pendant la période d'un (1) an à compter de la date d'achat, de bail ou de location originale, sauf dans les cas où les produits Kenwood sont employés dans un but professionnel ou commercial, où la garantie des pièces et de la main-d'œuvre demeure en vigueur pendant une période de quatre-vingt-dix (90) jours sous réserve des termes et des conditions de la garantie.

EXCLUSIONS DE GARANTIE
 Cette garantie ne couvre pas:
 (a) les produits achetés à l'étranger ou achetés au Canada et transportés à l'étranger;
 (b) les produits achetés à un concessionnaire non autorisé par KENWOOD;
 (c) les produits dont le numéro de série manque, a été effacé ou modifié;
 (d) les services d'entretien périodiques qui n'indiquent aucun défaut couvert par cette garantie;

COMMENT OBTENIR DU SERVICE SOUS GARANTIE
 Au cas où un service sous garantie de votre produit Kenwood s'avère nécessaire, veuillez livrer le produit à l'importe quel centre de service KENWOOD et présenter la copie originale du contrat de vente et cette carte de garantie en tant que preuve de garantie ou veuillez faire parvenir votre produit assuré et port payé au centre de service KENWOOD autorisé le plus proche. Pour éviter toutes possibilités de dommages pendant le transport, veuillez bien emballer le produit. Veuillez inclure une copie du contrat de vente original et cette carte de garantie en tant que preuve de garantie aussi bien que votre nom, numéros de téléphone au poste de travail et/ou au domicile, votre adresse et une description détaillée des défauts. Les produits sous garantie réparés seront retournés port payé aux destinations à l'intérieur du Canada. Le consommateur sera responsable de tous frais de transport et d'autres frais qui s'y rapportent pour faire expédier les produits à destinations à l'extérieur du Canada.

L'ENTIERE GARANTIE
 Cette garantie représente l'entière garantie donnée par écrit par KENWOOD. KENWOOD ne se tient aucunement responsable de toutes extensions ni de toutes augmentations de cette garantie faites ou entreprises par toutes personnes, parties, concessionnaires ou centres de service ou par leurs agents ou employés au nom de KENWOOD au moyen d'affirmations verbales ou écrites, d'annonces ou de promotions, y inclut tous programmes ou plans de garantie étendue que puissent offrir les concessionnaires ou les centres de service, à moins que KENWOOD n'y ait consenti par écrit d'avance.

RENONCIATION
 KENWOOD renonce à toutes responsabilités de perte de temps, d'emploi du produit, de tous dommages indirects ou accessoires causés à d'autres produits ou biens, de tous inconforts ou de toutes pertes commerciales.

AVIS AUX CONSOMMATEURS
 Les stipulations contenues dans la présente garantie écrite n'ont pas pour but de limiter, de modifier, de diminuer, de rejeter ni d'exclure d'autres garanties ni droits énoncés dans n'importe quelles lois ou législations provinciales ou fédérales.

IMPORTANT
 KENWOOD ne considère pas cette garantie toute seule comme étant une preuve d'achat valide. Lorsqu'on demande du service sous garantie, il faudra présenter la copie originale du contrat de vente aussi bien que cette carte de garantie en tant que preuve de garantie. On recommande de les conserver dans un lieu sûr au cas où elles s'avèreraient nécessaires à l'avenir.

JVCKENWOOD Canada Inc.
6070 Kestrel Road, Mississauga,
Ontario, Canada L5T 1S8
Téléphone: (905) 670-7211
Télécopieur: (905) 670-7248