

KDC-BT782HD KDC-X705

CD-RECEIVER

INSTRUCTION MANUAL

AUTORADIO CD

MODE D'EMPLOI

RECEPTOR CD

MANUAL DE INSTRUCCIONES

JVCKENWOOD Corporation

For your records

Record the serial number, found on the back of the unit, in the spaces designated on the warranty card, and in the space provided below. Refer to the model and serial numbers whenever you call upon your Kenwood dealer for information or service on the product.

Model KDC-BT782HD/KDC-X705

Serial number _____

US Residents Only

Register Online

Register your Kenwood product at <https://www.kenwood.com/usa/>

CAUTION

Use of controls or adjustments or performance of procedures other than those specified herein may result in hazardous radiation exposure.
In compliance with Federal Regulations, following are reproductions of labels on, or inside the product relating to laser product safety.

JVCKENWOOD Corporation
2967-3, ISHIKAWA-MACHI,
HACHIOJI-SHI, TOKYO, JAPAN

THIS PRODUCT COMPLIES WITH DHHS RULES 21CFR
SUBCHAPTER J IN EFFECT AT DATE OF MANUFACTURE.

Location : Top Plate

Información acerca de la eliminación de equipos eléctricos y electrónicos al final de la vida útil (aplicable a los países que hayan adoptado sistemas independientes de recogida de residuos)



Los productos con el símbolo de un contenedor con ruedas tachado no podrán ser desechados como residuos domésticos. Los equipos eléctricos y electrónicos al final de la vida útil, deberán ser reciclados en instalaciones que puedan dar el tratamiento adecuado a estos productos y a sus subproductos residuales correspondientes. Póngase en contacto con su administración local para obtener información sobre el punto de recogida más cercano. Un tratamiento correcto del reciclaje y la eliminación de residuos ayuda a conservar los recursos y evita al mismo tiempo efectos perjudiciales en la salud y el medio ambiente.

Informação sobre a eliminação de pilhas

Este produto não deve ser eliminado como lixo doméstico geral. Devolva a pilha usada ao revendedor ou entidade autorizada para que a mesma seja devolvida ao fabricante ou importador. A reciclagem e a eliminação de lixo de maneira apropriada ajudarão a conservar os recursos naturais ao mesmo tempo que prevenirão os efeitos prejudiciais à nossa saúde e ao meio ambiente.

CALIFORNIA, USA ONLY

This product contains a CR Coin Cell Lithium Battery which contains Perchlorate Material—special handling may apply. See www.dtsc.ca.gov/hazardouswaste/perchlorate

FCC CAUTION

Changes or modifications not expressly approved by the party responsible for compliance could void the user's authority to operate the equipment.

NOTE: This equipment has been tested and found to comply with the limits for a Class B digital device, pursuant to part 15 of the FCC Rules. These limits are designed to provide reasonable protection against harmful interference in a residential installation. This equipment generates, uses and can radiate radio frequency energy and, if not installed and used in accordance with the instructions, may cause harmful interference to radio communications. However, there is no guarantee that interference will not occur in a particular installation. If this equipment does cause harmful interference to radio or television reception, which can be determined by turning the equipment off and on, the user is encouraged to try to correct the interference by one or more of the following measures:

- Reorient or relocate the receiving antenna.
- Increase the separation between the equipment and receiver.
- Connect the equipment into an outlet on a circuit different from that to which the receiver is connected.
- Consult the dealer or an experienced radio/TV technician for help.

Supplier's Declaration of Conformity

Trade Name: KENWOOD
Products: CD-RECEIVER
Model Name: KDC-BT782HD/KDC-X705
Responsible Party: JVCKENWOOD USA CORPORATION
4001 Worsham Avenue, Long Beach, CA 90808, U.S.A.
PHONE: 1-800-252-5722

THIS DEVICE COMPLIES WITH PART 15 OF THE FCC RULES. OPERATION IS SUBJECT TO THE FOLLOWING TWO CONDITIONS:

- (1) THIS DEVICE MAY NOT CAUSE HARMFUL INTERFERENCE, AND
- (2) THIS DEVICE MUST ACCEPT ANY INTERFERENCE RECEIVED, INCLUDING INTERFERENCE THAT MAY CAUSE UNDESIRED OPERATION.

ISED Caution

This device contains licence-exempt transmitter(s)/receiver(s) that comply with Innovation, Science and Economic Development Canada's licence-exempt RSS(s). Operation is subject to the following two conditions:

1. This device may not cause interference.
2. This device must accept any interference, including interference that may cause undesired operation of the device.

Attention de l'ISED

L'émetteur/récepteur exempt de licence contenu dans le présent appareil est conforme aux CNR d'Innovation, Sciences et Développement économique Canada applicables aux appareils radio exempts de licence. L'exploitation est autorisée aux deux conditions suivantes :

1. L'appareil ne doit pas produire de brouillage.
2. L'appareil doit accepter tout brouillage radioélectrique subi, même si le brouillage est susceptible d'en compromettre le fonctionnement.

Contains Bluetooth Module FCC ID: ZWY88112
IC ID: 12033A-88112

This transmitter must not be co-located or operated in conjunction with any other antenna or transmitter.

CAUTION

This equipment complies with FCC/ISED radiation exposure limits set forth for an uncontrolled environment and meets the FCC radio frequency (RF) Exposure Guidelines and RSS-102 of the ISED radio frequency (RF) Exposure rules. This equipment should be installed and operated keeping the radiator at least 20 cm or more away from person's body.

ATTENTION

Cet équipement est conforme aux limites d'exposition aux rayonnements énoncées pour un environnement non contrôlé et respecte les règles des radioélectriques (RF) de la FCC lignes directrices d'exposition et d'exposition aux fréquences radioélectriques (RF) CNR-102 de l'ISED. Cet équipement doit être installé et utilisé en gardant une distance de 20 cm ou plus entre le radiateur et le corps humain.

Para cumplimiento de la IFT:

"La operación de este equipo está sujeta a las siguientes dos condiciones:

- (1) es posible que este equipo o dispositivo no cause interferencia perjudicial y
- (2) este equipo o dispositivo debe aceptar cualquier interferencia, incluyendo la que pueda causar su operación no deseada"

SOFTWARE LICENSE AGREEMENT

The software embedded in the Product (hereinafter the "Licensed Software") provided by Licensor is copyrighted to or sublicensable by the Licensor, and this Agreement provides for the terms and conditions which Users shall follow in order to use the Licensed Software.

The User shall use the Licensed Software by agreeing with the terms of this Software License Agreement. This Agreement shall be deemed completed at the time the User (hereinafter the "User") initially used the Product in which the "Licensed Software" is embedded.

The Licensed Software may include the software which has been licensed to the Licensor directly or indirectly from any third party. In such case, some third parties require the Users to follow their conditions for use separately from this Software License Agreement. Such software shall not be subject to this Agreement, and the Users are urged to read the "Important Notice concerning the Software" to be provided separately below.

Article 1 General Provision

The Licensor shall grant to the User a non-exclusive and non-transferable (other than the exceptional case referred to in Article 3, Paragraph 1) licensed to use the Licensed Software within the country of the User. (the country where the User bought the Product (hereinafter the "Country"))

Article 2 License

1. The license granted under this Agreement shall be the right to use the Licensed Software in the Product.
2. The User shall not duplicate, copy, modify, add, translate or otherwise alter, or lease the Licensed Software and any related documents, whether in whole or in part.
3. The use of the Licensed Software shall be limited to personal purpose, and the Licensed Software shall not be distributed, licensed or sub-licensed whether it is for commercial purpose or not.
4. The User shall use the Licensed Software according to the directions described in the operation manual or help file, and is prohibited to use or duplicate any data in a manner violating the Copyright Law or any other laws and regulations by applying whole or a part of the Licensed Software.

Article 3 Conditions for Grant of License

1. When the User transfers the Product, it may also transfer the license to use the Licensed Software embedded in the Product (including any related materials, updates and upgrades) on condition that no original, copies or related materials continue in the possession of the User, and that the User shall cause the transferee to comply with this Software License Agreement.
2. The User shall not carry out reverse engineering, disassembling, decompiling or any other code analysis works in connection with the Licensed Software.

Article 4 Right pertaining to the Licensed Software

Any and all copyrights and other rights pertaining to the Licensed Software and related documents shall belong to the Licensor or the original holder of the right who granted to the Licensor the license or sublicense for the Licensed Software (hereinafter the "Original Rightholder"), and the User shall not be entitled to any right other than the license granted hereunder, in respect of the Licensed Software and any related documents.

Article 5 Indemnification of Licensor

1. Neither the Licensor nor the Original Rightholder shall be liable for any damage incurred by the User or any third party due to the exercise of the license granted to the User under this Agreement, unless otherwise restricted by law.
2. The Licensor will offer no guarantee for the merchantability, convertibility and consistency with certain objective of the Licensed Software.

Article 6 Liability to Third Party

If any dispute has arisen with any third party due to an infringement upon a copyright, patent or any other intellectual property right that was caused by the User's use of the Licensed Software, the User shall settle such dispute at its own cost and hold the Licensor and the Original Rightholder harmless from any inconvenience it may cause.

Article 7 Confidentiality

The User shall keep the confidentiality of such portion of the Licensed Software, related documents thereof or any other information to be granted under this Agreement, as well as the conditions of this Agreement as has not yet entered the public domain, and shall not disclose or divulge the same to any third party without approval of the Licensor.

Article 8 Termination

In case the User falls under any of the events described in the following items, the Licensor may immediately terminate this Agreement or claim that the User compensates for the damage incurred by the Licensor due to such event:

- (1) when the User violated any provision of this Agreement; or
- (2) when a petition has been filed against the User for an attachment, provisional attachment, provisional disposition or any other compulsory execution.

Article 9 Destruction of the Licensed Software

If this Agreement is terminated pursuant to the provision of Article 8, the User shall destroy the Licensed Software, any related documents and copies thereof within two (2) weeks from such date of termination.

Article 10 Protection of Copyright

1. The copyright and all the other intellectual property rights relating to the Licensed Software shall belong to the Licensor and the Original Rightholder, and in no event shall they be under the ownership of the User.
2. The User shall, whenever it uses the Licensed Software, comply with any laws relating to the copyright and other intellectual property rights.

Article 11 Export Restriction

1. It is prohibited to export the Licensed Software and any related documents outside the country of the User (including transmission thereof outside the country of the User via Internet of other communication tools).
2. The User shall understand that the Licensed Software shall be subject to the export restrictions adopted by the country of User and any other countries.
3. The User shall agree that the software will be subject to any and all applicable international and domestic laws (including the export control regulation of the country of User and any other countries, and any restrictions concerning the end-users, the use by end-users and importing countries to be provided by the country of User and any other countries, and any other governmental authorities).

Article 12 Miscellaneous

1. In the event any part of this Agreement is invalidated by operation of law, the residual provisions shall continue in force.
2. Matters not stipulated in this Agreement or any ambiguity or question raised in the construction of this Agreement shall be provided or settled upon good-faith consultation between the Licensor and the User.
3. The Licensor and the User hereby agree that this Agreement is governed by the laws of Japan, and any dispute arising from, and relating to the rights and obligations under, this Agreement shall be submitted to the exclusive jurisdiction of the Tokyo District Court for its first instance.

Important Notice concerning the Software

-jansson

Copyright (c) 2009-2012 Petri Lehtinen <petri@digip.org>

Permission is hereby granted, free of charge, to any person obtaining a copy of this software and associated documentation files (the "Software"), to deal in the Software without restriction, including without limitation the rights to use, copy, modify, merge, publish, distribute, sublicense, and/or sell copies of the Software, and to permit persons to whom the Software is furnished to do so, subject to the following conditions:

The above copyright notice and this permission notice shall be included in all copies or substantial portions of the Software.

THE SOFTWARE IS PROVIDED "AS IS", WITHOUT WARRANTY OF ANY KIND, EXPRESS OR IMPLIED, INCLUDING BUT NOT LIMITED TO THE WARRANTIES OF MERCHANTABILITY, FITNESS FOR A PARTICULAR PURPOSE AND NONINFRINGEMENT. IN NO EVENT SHALL THE AUTHORS OR COPYRIGHT HOLDERS BE LIABLE FOR ANY CLAIM, DAMAGES OR OTHER LIABILITY, WHETHER IN AN ACTION OF CONTRACT, TORT OR OTHERWISE, ARISING FROM, OUT OF OR IN CONNECTION WITH THE SOFTWARE OR THE USE OR OTHER DEALINGS IN THE SOFTWARE.

-cJSON

Copyright (c) 2009 Dave Gamble

Permission is hereby granted, free of charge, to any person obtaining a copy of this software and associated documentation files (the "Software"), to deal in the Software without restriction, including without limitation the rights to use, copy, modify, merge, publish, distribute, sublicense, and/or sell copies of the Software, and to permit persons to whom the Software is furnished to do so, subject to the following conditions:

The above copyright notice and this permission notice shall be included in all copies or substantial portions of the Software.

THE SOFTWARE IS PROVIDED "AS IS", WITHOUT WARRANTY OF ANY KIND, EXPRESS OR IMPLIED, INCLUDING BUT NOT LIMITED TO THE WARRANTIES OF MERCHANTABILITY, FITNESS FOR A PARTICULAR PURPOSE AND NONINFRINGEMENT. IN NO EVENT SHALL THE AUTHORS OR COPYRIGHT HOLDERS BE LIABLE FOR ANY CLAIM, DAMAGES OR OTHER LIABILITY, WHETHER IN AN ACTION OF CONTRACT, TORT OR OTHERWISE, ARISING FROM, OUT OF OR IN CONNECTION WITH THE SOFTWARE OR THE USE OR OTHER DEALINGS IN THE SOFTWARE.

-CMP

The MIT License (MIT)

Copyright (c) 2014 Charles Gunyon

Permission is hereby granted, free of charge, to any person obtaining a copy of this software and associated documentation files (the "Software"), to deal in the Software without restriction, including without limitation the rights to use, copy, modify, merge, publish, distribute, sublicense, and/or sell copies of the Software, and to permit persons to whom the Software is furnished to do so, subject to the following conditions:

The above copyright notice and this permission notice shall be included in all copies or substantial portions of the Software.

THE SOFTWARE IS PROVIDED "AS IS", WITHOUT WARRANTY OF ANY KIND, EXPRESS OR IMPLIED, INCLUDING BUT NOT LIMITED TO THE WARRANTIES OF MERCHANTABILITY, FITNESS FOR A PARTICULAR PURPOSE AND NONINFRINGEMENT. IN NO EVENT SHALL THE AUTHORS OR COPYRIGHT HOLDERS BE LIABLE FOR ANY CLAIM, DAMAGES OR OTHER LIABILITY, WHETHER IN AN ACTION OF CONTRACT, TORT OR OTHERWISE, ARISING FROM, OUT OF OR IN CONNECTION WITH THE SOFTWARE OR THE USE OR OTHER DEALINGS IN THE SOFTWARE.

nanopb

Copyright (c) 2011 Petteri Aimonen <jpa at nanopb.mail.kapsi.fi>

This software is provided 'as-is', without any express or implied warranty. In no event will the authors be held liable for any damages arising from the use of this software.

Permission is granted to anyone to use this software for any purpose, including commercial applications, and to alter it and redistribute it freely, subject to the following restrictions:

1. The origin of this software must not be misrepresented; you must not claim that you wrote the original software. If you use this software in a product, an acknowledgment in the product documentation would be appreciated but is not required.
2. Altered source versions must be plainly marked as such, and must not be misrepresented as being the original software.
3. This notice may not be removed or altered from any source distribution.

sha2

AUTHOR: Aaron D. Gifford - <http://www.aarongifford.com/>

Copyright (c) 2000-2001, Aaron D. Gifford

All rights reserved.

You may obtain a copy of the license at

<https://opensource.org/licenses/BSD-3-Clause>

THE SOFTWARE IS PROVIDED "AS IS", WITHOUT WARRANTY OF ANY KIND, EXPRESS OR IMPLIED, INCLUDING BUT NOT LIMITED TO THE WARRANTIES OF MERCHANTABILITY, FITNESS FOR A PARTICULAR PURPOSE AND NONINFRINGEMENT. IN NO EVENT SHALL THE AUTHORS OR COPYRIGHT HOLDERS BE LIABLE FOR ANY CLAIM, DAMAGES OR OTHER LIABILITY, WHETHER IN AN ACTION OF CONTRACT, TORT OR OTHERWISE, ARISING FROM, OUT OF OR IN CONNECTION WITH THE SOFTWARE OR THE USE OR OTHER DEALINGS IN THE SOFTWARE.

Posix

Copyright (c) 1990, 1993

The Regents of the University of California. All rights reserved.

Redistribution and use in source and binary forms, with or without modification, are permitted provided that the following conditions are met:

1. Redistributions of source code must retain the above copyright notice, this list of conditions and the following disclaimer.
2. Redistributions in binary form must reproduce the above copyright notice, this list of conditions and the following disclaimer in the documentation and/or other materials provided with the distribution.
3. All advertising materials mentioning features or use of this software must display the following acknowledgement:
This product includes software developed by the University of California, Berkeley and its contributors.
4. Neither the name of the University nor the names of its contributors may be used to endorse or promote products derived from this software without specific prior written permission.

Copyright (C) 1993 by Sun Microsystems, Inc. All rights reserved.

Developed at SunPro, a Sun Microsystems, Inc. business.

Permission to use, copy, modify, and distribute this software is freely granted, provided that this notice is preserved.

Copyright (C) 1991-2, RSA Data Security, Inc. Created 1991. All rights reserved.

License to copy and use this software is granted provided that it is identified as the "RSA Data Security, Inc. MD4 Message-Digest Algorithm" in all material mentioning or referencing this software or this function.

Copyright (c) 1995, 1996 Carnegie-Mellon University. All rights reserved.

Author: Chris G. Demetriou

Permission to use, copy, modify and distribute this software and its documentation is hereby granted, provided that both the copyright notice and this permission notice appear in all copies of the software, derivative works or modified versions, and any portions thereof, and that both notices appear in supporting documentation.

CARNEGIE MELLON ALLOWS FREE USE OF THIS SOFTWARE IN ITS "AS IS" CONDITION. CARNEGIE MELLON DISCLAIMS ANY LIABILITY OF ANY KIND FOR ANY DAMAGES WHATSOEVER RESULTING FROM THE USE OF THIS SOFTWARE.

Carnegie Mellon requests users of this software to return to

Software Distribution Coordinator or Software.Distribution@CS.CMU.EDU

School of Computer Science

Carnegie Mellon University

Pittsburgh PA 15213-3890

any improvements or extensions that they make and grant Carnegie the rights to redistribute these changes.

License is also granted to make and use derivative works provided that such works are identified as "derived from the RSA Data Security, Inc. MD4 Message-Digest Algorithm" in all material mentioning or referencing the derived work.

RSA Data Security, Inc. makes no representations concerning either the merchantability of this software or the suitability of this software for any particular purpose. It is provided "as is" without express or implied warranty of any kind.

Copyright (c) 1993 Martin Birgmeier

All rights reserved.

You may redistribute unmodified or modified versions of this source code provided that the above copyright notice and this and the following conditions are retained.

This software is provided "as is", and comes with no warranties of any kind. I shall in no event be liable for anything that happens to anyone/anything when using this software.

These notices must be retained in any copies of any part of this documentation and/or software.

T-Kernel 2.0

This product uses the source code of T-Kernel 2.0 under T-License 2.0 granted by T-Engine Forum (www.tron.org)

BSD-3-Clause

Copyright (c) 2000-2001, Aaron D. Gifford

All rights reserved.

You may obtain a copy of the license at

<https://opensource.org/licenses/BSD-3-Clause>

THE SOFTWARE IS PROVIDED "AS IS", WITHOUT WARRANTY OF ANY KIND, EXPRESS OR IMPLIED, INCLUDING BUT NOT LIMITED TO THE WARRANTIES OF MERCHANTABILITY, FITNESS FOR A PARTICULAR PURPOSE AND NONINFRINGEMENT. IN NO EVENT SHALL THE AUTHORS OR COPYRIGHT HOLDERS BE LIABLE FOR ANY CLAIM, DAMAGES OR OTHER LIABILITY, WHETHER IN AN ACTION OF CONTRACT, TORT OR OTHERWISE, ARISING FROM, OUT OF OR IN CONNECTION WITH THE SOFTWARE OR THE USE OR OTHER DEALINGS IN THE SOFTWARE.

LFS Subsystem

Copyright The Regents of the University of California. All rights reserved.

You may obtain a copy of the license at

<https://directory.fsf.org/wiki/License:BSD-4-Clause>

THE SOFTWARE IS PROVIDED "AS IS", WITHOUT WARRANTY OF ANY KIND, EXPRESS OR IMPLIED, INCLUDING BUT NOT LIMITED TO THE WARRANTIES OF MERCHANTABILITY, FITNESS FOR A PARTICULAR PURPOSE AND NONINFRINGEMENT. IN NO EVENT SHALL THE AUTHORS OR COPYRIGHT HOLDERS BE LIABLE FOR ANY CLAIM, DAMAGES OR OTHER LIABILITY, WHETHER IN AN ACTION OF CONTRACT, TORT OR OTHERWISE, ARISING FROM, OUT OF OR IN CONNECTION WITH THE SOFTWARE OR THE USE OR OTHER DEALINGS IN THE SOFTWARE.

Accordo2 Player

Apache License

Licensed under the Apache License,

Version 2.0, January 2004(the "License");

You may obtain a copy of the license at

<http://www.apache.org/licenses/LICENSE-2.0>

THE SOFTWARE IS PROVIDED "AS IS", WITHOUT WARRANTY OF ANY KIND, EXPRESS OR IMPLIED, INCLUDING BUT NOT LIMITED TO THE WARRANTIES OF MERCHANTABILITY, FITNESS FOR A PARTICULAR PURPOSE AND NONINFRINGEMENT. IN NO EVENT SHALL THE AUTHORS OR COPYRIGHT HOLDERS BE LIABLE FOR ANY CLAIM, DAMAGES OR OTHER LIABILITY, WHETHER IN AN ACTION OF CONTRACT, TORT OR OTHERWISE, ARISING FROM, OUT OF OR IN CONNECTION WITH THE SOFTWARE OR THE USE OR OTHER DEALINGS IN THE SOFTWARE.

Contents

Before Use.....	3	References	33
Basics	4	Maintenance	
Getting Started	5	More information	
1 Select the display language and cancel the demonstration		Change the display information	
2 Set the clock and date		Troubleshooting.....	36
3 Set the other optional settings		Specifications	39
HD Radio™ Tuner	7		
CD/USB/iPod.....	9		
SiriusXM® Radio	12		
AUX.....	15		
KENWOOD Remote Application	15		
Bluetooth®	16		
Bluetooth – Connection			
Bluetooth – Mobile phone			
Bluetooth – Audio			
AMAZON ALEXA	23		
Audio Settings.....	25		
Display Settings.....	29		
Installation/Connection	30		

How to read this manual

- The displays and faceplates shown in this manual are examples used to provide clear explanations of the operations. For this reason, they may be different from the actual displays or faceplates.
- Operations are explained mainly using buttons on the faceplate of **KDC-BT782HD**.
- English indications are used for the purpose of explanation. You can select the display language from the **[FUNCTION]** menu. (Page 6)
- **[XX]** indicates the selected items.
- (Page XX) indicates references are available on the stated page.



This symbol on the product means there are important operating and maintenance instructions in this manual. Be sure to carefully read instructions in this manual.

Before Use

IMPORTANT

- To ensure proper use, please read through this manual before using this product. It is especially important that you read and observe Warnings and Cautions in this manual.
- Please keep the manual in a safe and accessible place for future reference.

▲ WARNING

- **Do not operate any function that takes your attention away from safe driving.**

- **Do not ingest the battery, Chemical Burn Hazard.**

The remote control supplied with this product contains a coin/button cell battery.

If the coin/button cell battery is swallowed, it can cause severe internal burns in just 2 hours and can lead to death.

Keep new and used batteries away from children.

If the battery compartment does not close securely, stop using the product and keep it away from children.

If you think batteries might have been swallowed or placed inside any part of the body, seek immediate medical attention.

▲ CAUTION

Volume setting:

- Adjust the volume so that you can hear sounds outside the car to prevent accidents.
- Lower the volume before playing digital sources to avoid damaging the speakers by the sudden increase of the output level.

General:

- Avoid using the external device if it might hinder safe driving.
- Make sure all important data has been backed up. We shall bear no responsibility for any loss of recorded data.
- Never put or leave any metallic objects (such as coins or metal tools) inside the unit to prevent a short circuit.
- If a disc error occurs due to condensation on the laser lens, eject the disc and wait for the moisture to evaporate.
- USB rating is indicated on the main unit. To view, detach the faceplate. (Page 4)
- Depending on the types of cars, the antenna will automatically extend when you turn on the unit with the antenna control wire connected (page 32). Turn off the unit or change the source to STANDBY when parking at a low ceiling area.

Remote control (RC-406):

- Do not leave the remote control in hot places such as on the dashboard.
- Risk of fire or explosion if the battery is replaced by an incorrect type. Ensure to replace only with the same type.
- Risk of fire, explosion or the leakage of flammable liquid or gas if the battery is left in an extremely high temperature surrounding environment and/or subjected extremely low air pressure. The battery pack or batteries shall not be exposed to excessive heat such as sunshine, fire or the like.
- Risk of fire, explosion or the leakage of flammable liquid or gas if the battery is disposed into fire or a hot oven, recharged, shorted, mechanically crushed or cut of the battery.
- If spilled fluid comes in contact with your eyes or on clothing, immediately rinse with water and consult a physician.

Basics

Faceplate

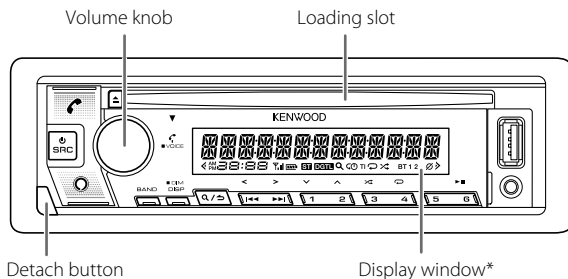

* Only for illustration purpose.

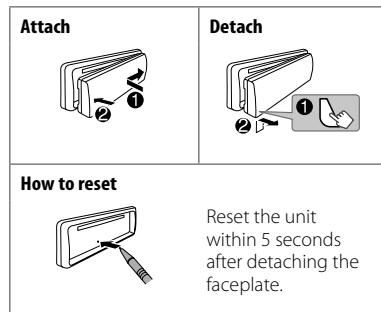

To

Turn on the power

On the faceplate

Press SRC.
• Press and hold to turn off the power.

Adjust the volume

Turn the volume knob.

Select a source

• Press SRC repeatedly.
• Press SRC, then turn the volume knob within 2 seconds.

Change the display information

Press DISP repeatedly. (Page 35)

Basics

Remote control (RC-406)

This unit can be remotely controlled with an optionally purchased remote control.

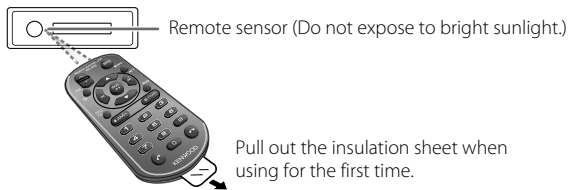

How to replace the battery



To	On the remote control
Adjust the volume	Press VOL ▲ or VOL ▼. • Press and hold VOL ▲ to continuously increase the volume to 15. Press ATT during playback to attenuate the sound. • Press again to cancel.
Select a source	Press SRC repeatedly.
Turn off the power	Press and hold SRC to turn off the power. (Pressing SRC does not turn on the power.)

Getting Started



1 Select the display language and cancel the demonstration

When you turn on the power for the first time (or [FACTORY RESET] is set to [YES], see page 6), the display shows: "SEL LANGUAGE" → "PRESS" → "VOLUME KNOB"

- 1 Turn the volume knob to select [ENG] (English) / [SPA] (Spanish) / [FRE] (French), then press the knob.
[ENG] is selected for the initial setup.
Then, the display shows: "CANCEL DEMO" → "PRESS" → "VOLUME KNOB".
- 2 Press the volume knob again.
[YES] is selected for the initial setup.
- 3 Press the volume knob again.
"DEMO OFF" appears.

2 Set the clock and date

- 1 Press the volume knob to enter [FUNCTION].
- 2 Turn the volume knob to select [CLOCK], then press the knob.

To adjust the clock

- 3 Turn the volume knob to select [CLOCK ADJUST], then press the knob.
- 4 Turn the volume knob to make the settings, then press the knob.
Set the time in the order of "Hour" → "Minute".
- 5 Turn the volume knob to select [CLOCK FORMAT], then press the knob.
- 6 Turn the volume knob to select [12H] or [24H], then press the knob.

Getting Started

To set the date

- Turn the volume knob to select [DATE FORMAT], then press the knob.
- Turn the volume knob to select [DD/MM/YY] or [MM/DD/YY], then press the knob.
- Turn the volume knob to select [DATE SET], then press the knob.
- Turn the volume knob to make the settings, then press the knob.
Set the date in the order of "Day" → "Month" → "Year" or "Month" → "Day" → "Year".
- Press and hold **Q/↵** to exit.

To return to the previous setting item, press **Q/↵**.

3

Set the other optional settings

You can only set the following items while the unit is in STANDBY source.

- Press **⏻SRC** repeatedly to enter STANDBY.
- Press the volume knob to enter [FUNCTION].
- Turn the volume knob to select an item (see the following table), then press the knob.
- Repeat step 3 until the desired item is selected/activated.
- Press and hold **Q/↵** to exit.

To return to the previous setting item, press **Q/↵**.

Default: **[XX]**

[DISPLAY]	
[EASY MENU]	When entering [FUNCTION]... [ON]: [ZONE 1] illumination changes to white color. ; [OFF]: [ZONE 1] illumination remains as [COLOR SELECT] color. (Page 29) <ul style="list-style-type: none">[ZONE 2] illumination changes to light blue color when you enter [FUNCTION], irregardless of the [EASY MENU] setting.Refer to the illustration on page 29 for zone identification.

[TUNER SETTING]	
[PRESET TYPE]	[NORMAL]: Memorizes one station for each preset button in each band (FM1/FM2/FM3/AM). ; [MIX]: Memorizes one station or SiriusXM channel for each preset button, regardless of the selected band or SiriusXM channel.
[SYSTEM]	
[KEY BEEP]	[ON]: Activates the keypress tone. ; [OFF]: Deactivates.
[SOURCE SELECT]	
[BT AUDIO SRC]	[ON]: Enables BT AUDIO in source selection. ; [OFF]: Disables. (Page 22)
[BUILT-IN AUX]	[ON]: Enables AUX in source selection. ; [OFF]: Disables. (Page 15)
[CD READ]	[1]: Automatically distinguishes between audio file disc and music CD. ; [2]: Forces to play as a music CD. No sound can be heard if an audio file disc is played.
[F/W UPDATE]	
[UPDATE SYSTEM]*/[UPDATE HD]	
[F/W UP xxxx]/ [F/W UP Vxx]	[YES]: Starts upgrading the firmware. ; [NO]: Cancels (upgrading is not activated). For details on how to update the firmware, visit < https://www.kenwood.com/cs/ce/ >. * Once you have upgraded the firmware, you are unable to downgrade the firmware.
[FACTORY RESET]	[YES]: Resets the settings to default (except the stored station). ; [NO]: Cancels.
[ENGLISH]	Select the display language for [FUNCTION] menu and music information if applicable.
[ESPAÑOL]	By default, [ENGLISH] is selected.
[FRANCAIS]	

HD Radio™ Tuner

You can tune in to both conventional and HD Radio broadcasts.

- To find HD Radio stations in your area, visit <<http://www.hdradio.com>>.



- "ST" indicator lights up when receiving an FM stereo broadcast with sufficient signal strength.

Search for a station or channel

- 1 Press **SRC** repeatedly to select HD RADIO.
- 2 Press **BAND** repeatedly (or press **#FM+/*AM-** on the remote control) to select FM1/FM2/FM3/AM.
- 3 Press **◀◀/▶▶** (or press **◀◀/▶▶(+)** on the remote control) to search for a station or channel.

You can store up to 18 stations/channels for FM and 6 stations/channels for AM.

- **To store a station or channel:** Press and hold one of the number buttons (1 to 6).
- **To select a stored station or channel:** Press one of the number buttons (1 to 6) (or press one of the number buttons (1 to 6) on the remote control).

Direct Access Tuning (using the remote control)

- 1 Press **DIRECT** to enter Direct Access Tuning.
- 2 Press the number buttons to enter a station frequency or channel number.
- 3 Press **ENT ▶▶** to search for station or channel.

- To cancel, press **↶** or **DIRECT**.
- If no operation is done for 10 seconds after step 2, Direct Access Tuning is automatically canceled.

Select an HD Radio multicast channel

Many HD Radio stations offer more than one channel programming. This service is called multicasting.

While receiving HD Radio multicast channels...

Press **◀◀/▶▶** to select your desired channel (HD1 to HD8).
"LINKING" appears while linking to a multicast channel.

Receive an Emergency Alert message

You can receive an emergency alert message while listening to another source or while in **STANDBY**, via HD Radio Broadcast.

■ Activate emergency alert message reception

- 1 Press the volume knob to enter **[FUNCTION]**.
- 2 Turn the volume knob to select **[TUNER SETTING]**, then press the knob.
- 3 Turn the volume knob to select **[EA]**, then press the knob.
- 4 Turn the volume knob to select **[ON]**, then press the knob.
- 5 Press and hold **Q/↶** to exit.

- To deactivate emergency alert message reception, select **[OFF]** in step 4.
- To return to the previous setting item, press **Q/↶**.

HD Radio™ Tuner

Receive an emergency alert message

When an emergency alert message is received, it appears and remains on the display until the user performs the "Ignore" function.

Press **SRC** (or press **SRC** on the remote control) to ignore the alert message.

The same emergency alert message will not interrupt again for 12 hours.

Display received emergency alert messages

The received emergency alert messages are stored in the Alert Message List, and you can check them later.

While listening to the HD RADIO source...

- 1 Press **Q/➔** to display the Alert Message List.
- 2 Turn the volume knob to select a message.
- 3 Press the volume knob to display the information related to the message.
- 4 Press **Q/➔** again to exit.

- "NO LIST" appears when the list is empty.
- This feature can store up to four messages in the list.
- To clear the message list, set **[FACTORY RESET]** to **[YES]**. (Page 6)

Other settings

- 1 Press the volume knob to enter **[FUNCTION]**.
- 2 Turn the volume knob to select an item (see the following table), then press the knob.
- 3 Repeat step 2 until the desired item is selected/activated or follow the instructions stated on the selected item.
- 4 Press and hold **Q/➔** to exit.

To return to the previous setting item, press **Q/➔**.

Default: **[XX]**

[TUNER SETTING]	
[SEEK MODE]	Selects the searching method for ◀◀ / ▶▶ buttons when pressed. [AUTO1] : Automatically search for a station or channel. ; [AUTO2] : Search for a preset station or channel. ; [MANUAL] : Manually search for a station or channel.
[IF BAND]	[AUTO] : Increases the tuner selectivity to reduce interference noises from adjacent FM stations. (Stereo effect may be lost.) ; [WIDE] : Subjects to interference noises from adjacent FM stations, but sound quality will not be degraded and the stereo effect will remain.
[AUTO MEMORY]	[YES] : Automatically starts memorizing 6 stations with good reception. ; [NO] : Cancels. • Selectable only if [NORMAL] is selected for [PRESET TYPE] . (Page 6)
[EA]	[ON] : Activates emergency alert message reception. ; [OFF] : Deactivates. (Page 7)
[RECEIVE MODE]	Sets the receive mode of the HD Radio receiver. [AUTO] : Automatically tunes to analog broadcast when there is no digital broadcast. ; [DIGITAL] : Tunes in to digital broadcast only. ; [ANALOG] : Tunes in to analog broadcast only.
[CLOCK]	
[TIME SYNC]	[ON] : Synchronizes the unit's time to the Radio Broadcast Data System station time. ; [OFF] : Cancels.

CD/USB/iPod

Insert a disc

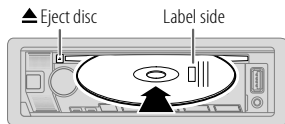

The source changes to CD automatically and playback starts.

Connect a USB device

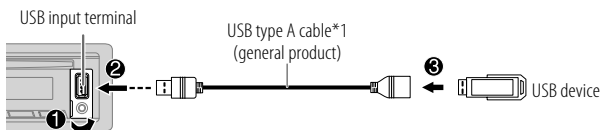

The source changes to USB automatically and playback starts.

Connect an iPod/iPhone

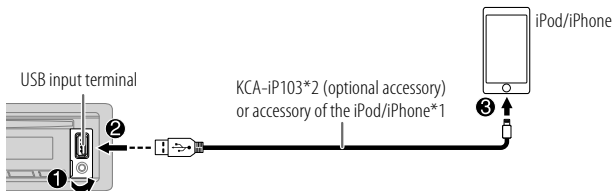

See "Set the playable source for iPod/iPhone" on page 10 to start playback.

• You can also connect iPod/iPhone via Bluetooth. (Page 17)

*1 Do not leave the cable inside the car when not in use.

*2 KCA-iP103: Lightning type

Basic operations

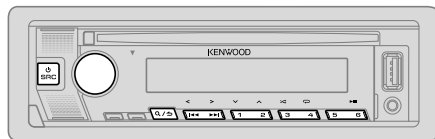

Selectable sources: CD/USB/iPod USB or iPod BT

For playable audio file, see "Playable files" on page 34.

To	On the faceplate	On the remote control
Play back/pause	Press 6 ▶▶ .	Press ENT ▶▶ .
Reverse/Fast-forward	Press and hold ◀◀ / ▶▶ .	Press and hold ◀◀ / ▶▶ (+) .
Select a track/file	Press ◀◀ / ▶▶ .	Press ◀◀ / ▶▶ (+) .
Select a folder*	Press 2 ^ / v .	Press #FM+/*AM- .
Repeat play	Press 4 ↺ repeatedly. [TRACK REPEAT]/[ALL REPEAT]: Audio CD [FILE REPEAT]/[FOLDER REPEAT]/[ALL REPEAT]: MP3/WMA/AAC/WAV/FLAC file [REPEAT ONE]/[REPEAT ALL]/[REPEAT OFF]: iPod	
Random play	Press 3 ⌘ repeatedly. [DISC RANDOM]/[RANDOM OFF]: Audio CD [FOLDER RANDOM]/[RANDOM OFF]: MP3/WMA/AAC/WAV/FLAC file [SHUFFLE ON]/[SHUFFLE OFF]: iPod	
		Press and hold 3 ⌘ to select [ALL RANDOM]* .

* For CD: Only for MP3/WMA/AAC files. This does not work for iPod.

CD/USB/iPod

Select music drive

While in USB source, press 5 repeatedly.

Stored songs in the following drive will be played back.

- Selected internal or external memory of a smartphone (Mass Storage Class).
- Selected drive of a multiple drive device. (This unit can support multiple drive device of up to 4 drives. However, this unit may take some time to read if three or more cards are connected.)

You can also select the music drive from the [FUNCTION] menu.

- 1 Press the volume knob to enter [FUNCTION].
- 2 Turn the volume knob to select [USB], then press the knob.
- 3 Turn the volume knob to select [MUSIC DRIVE], then press the knob.
- 4 Turn the volume knob to select [DRIVE CHANGE], then press the knob.
The next drive ([DRIVE 1] to [DRIVE 4]) is selected automatically and playback starts.
- 5 Repeat step 1 to step 4 to select the following drives.
- 6 Press and hold Q/↵ to exit.

To return to the previous setting item, press Q/↵.

Direct Music Search (using the remote control)

- 1 Press DIRECT.
- 2 Press the number buttons to enter a file number.
- 3 Press ENT ▶|| to search for music.

- To cancel, press ↵ or DIRECT.
- Not available if Random Play is selected.
- Not applicable for iPod USB.

Set the playable source for iPod/iPhone

You can make the following setting at all sources except at iPod USB source and iPod BT source.

- 1 Press the volume knob to enter [FUNCTION].
- 2 Turn the volume knob to select an item (see the following table), then press the knob.
- 3 Repeat step 2 until the desired item is selected/activated.
- 4 Press and hold Q/↵ to exit.

To return to the previous setting item, press Q/↵.

Default: [XX]

[USB]

[IPHONE SETUP]

[BT]: iPod BT source is available if iPod/iPhone is connected via Bluetooth.

- If you connect the iPod/iPhone via USB input terminal, iPod USB source is not available.
However, once the Bluetooth is disconnected, iPod USB source will become available. ;

[USB]: iPod USB source is available if iPod/iPhone is connected via USB input terminal, regardless of whether Bluetooth connection is available or not.

- Alexa mobile application cannot be used when iPod USB source is selected.

Select a file to play

From a folder or list

- 1 Press **Q/↵**.
- 2 Turn the volume knob to select a folder/list, then press the knob.
- 3 Turn the volume knob to select a file, then press the knob.
Selected file starts playing.

Quick search (applicable only for CD source and USB source)

If you have many files, you can search through them quickly.

- 1 Press **Q/↵**.
- 2 Turn the volume knob to select a folder/list, then press the knob.
- 3 Turn the volume knob quickly to browse through the list quickly.
- 4 Turn the volume knob to select a file, then press the knob.
Selected file starts playing.

Skip search (applicable only for iPod USB source and iPod BT source)

If you have many files in the selected list, you can perform the following to search for a file by skipping through the list at a rate selected in [SKIP SEARCH].

- 1 Press **Q/↵**.
- 2 Turn the volume knob to select a list, then press the knob.
- 3 Press **◀◀/▶▶** to search at a preset skip search ratio.
 - Pressing and holding **◀◀/▶▶** searches at a 10% ratio irregardless of the [SKIP SEARCH] settings.
- 4 Turn the volume knob to select a file, then press the knob.
Selected file starts playing.

[SKIP SEARCH] setting

- 1 Press the volume knob to enter [FUNCTION].
- 2 Turn the volume knob to select [USB], then press the knob.
- 3 Turn the volume knob to select [SKIP SEARCH], then press the knob.
- 4 Turn the volume knob to select the skip search ratio, then press the knob.
[0.5%] (default)/[1%]/[5%]/[10%]
The skip search ratio is shown as a percentage of the total files.
- 5 Press and hold **Q/↵** to exit.

Alphabet search (applicable only for iPod USB source and iPod BT source)

You can search for a file according to the first character.

- 1 Press **Q/↵**.
 - 2 Turn the volume knob to select a list, then press the knob.
 - 3 Turn the volume knob quickly to enter character search.
 - 4 Turn the volume knob to select the character.
 - Select "*" to search for a character other than A to Z, 0 to 9.
 - 5 Press **◀◀/▶▶** to move to the entry position.
 - You can enter up to 3 characters.
 - 6 Press the volume knob to start searching.
 - 7 Turn the volume knob to select a file, then press the knob.
Selected file starts playing.
- To return to the root folder/first file/top menu, press 5. (Not applicable for BT AUDIO source.)
 - To return to the previous setting item, press **Q/↵**.
 - To cancel, press and hold **Q/↵**.

SiriusXM® Radio

Only SiriusXM® brings you more of what you love to listen to, all in one place. Get over 140 channels, including commercial-free music plus the best sports, news, talk, comedy and entertainment. Welcome to the world of satellite radio.

A SiriusXM Vehicle Tuner and Subscription are required.

- For more information, visit <www.siriusxm.com>.

Preparation:

- 1 Connect the optional SiriusXM Vehicle Tuner (commercially available).

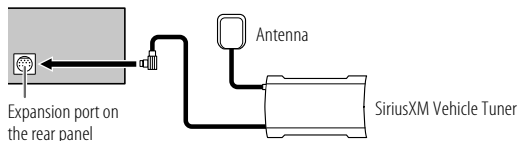

- 2 Check your Radio ID for activation.

The SiriusXM Radio ID is required for activation and can be found by tuning to Channel 0 as well as on the label found on the SiriusXM Vehicle Tuner and its packaging.

The Radio ID does not include the letters I, O, S or F.

- 3 Activate the subscription.

For users in the U.S.A.:

Online: Go to <www.siriusxm.com/activatenow>

Phone: Call 1-866-635-2349

For users in Canada:

Online: Go to <www.siriusxm.ca/activate>

Phone: Call 1-888-539-7474

- 4 Press \odot SRC repeatedly to select SIRIUS XM to start updating.

Start listening

- 1 Press \odot SRC repeatedly to select SIRIUS XM.
- 2 Press BAND repeatedly to select a band.
- 3 Press \mathcal{R} / \rightarrow .
"R" indicator lights up.
- 4 Turn the volume knob to select a category, then press the knob.
If "ALL CHANNELS" is selected, all the available channels will be shown.
- 5 Turn the volume knob to select a channel, then press the knob.
 - Pressing and holding 1/2 changes the channel rapidly.
 - If no operation is done for 10 seconds, a channel will be selected automatically.(or)
Press \lll / \ggg to search for a channel manually.
 - Pressing and holding \lll / \ggg changes the channel rapidly.

If a locked channel or a mature channel is selected, a pass code input screen appears. Enter the pass code to receive the channel. (Page 14)

Direct Access Tuning (using the remote control)

- 1 Press DIRECT to enter Direct Access Tuning.
 - 2 Press the number buttons to enter a channel number.
 - 3 Press ENT \blacksquare to search for the channel.
- To cancel, press \rightarrow or DIRECT.
 - If no operation is done for 10 seconds after step 2, Direct Access Tuning is automatically canceled.

SiriusXM® Radio

Parental Control

The Parental Control feature allows you to limit access to any SiriusXM channels, including those with mature content. When enabled, the Parental Control feature requires you to enter a pass code to tune to the locked channels.

- Information on setting up the pass code and locking channels can be found on page 14.

SiriusXM Keymode

Press and hold the volume knob to change the keymode (channel or replay). (Default: Channel keymode)

“” indicator lights up when replay keymode is selected.

When channel keymode is selected...

To	On the faceplate	On the remote control
Select a channel	Press I◀◀ / ▶▶I .	Press I◀◀ / ▶▶I (+) .
Change a channel rapidly	Press and hold I◀◀ / ▶▶I .	Press and hold I◀◀ / ▶▶I (+) .
Store a channel of the current band	Press and hold one of the number buttons (1 to 6).	(Not available)
Select a stored channel of the current band	Press one of the number buttons (1 to 6).	Press one of the number buttons (1 to 6).

When replay keymode is selected...

To	On the faceplate	On the remote control
Play back/pause	Press 6 ▶▶I .	Press ENT ▶▶I .
Skip backward/forward	Press I◀◀ / ▶▶I* .	Press I◀◀ / ▶▶I (+)* .
Rewind/Fast-forward	Press and hold I◀◀ / ▶▶I* .	Press and hold I◀◀ / ▶▶I (+)* .
Go to Live	Press 1* .	Press 1* .

* When Live is reached or selected, keymode is automatically changed to channel keymode.

SmartFavorites and TuneStart™

User stored channels are recognized as SmartFavorite channels*. The SiriusXM Vehicle Tuner automatically buffers the broadcast content in the background.

- SmartFavorites feature is available with SXV200 or later SiriusXM Vehicle Tuner.

* SXV300 (and later) SiriusXM Vehicle Tuner can use all 18 stored channels as SmartFavorites. The SXV200 SiriusXM Vehicle Tuner can use 6 stored channels from the current band as SmartFavorites.

When you select a SmartFavorite channel, you can rewind and replay up to 30 minutes of any of the missed news, talk, sports or music content.

- Playback starts from the beginning of the song if [TUNE START] is set to [ON] (page 14) for most music channels stored as a SmartFavorite.

Press one of the number buttons (1 to 6) to select a stored channel.

SiriusXM® Radio

TuneScan™

You can get a short preview of the songs that you have missed on each of your SmartFavorites music channels or a music channel currently tuned into.

Press and hold **BAND** to start scanning the first 6 seconds of the recorded music contents.

- To listen to the current song, press the volume knob to stop scanning. The unit continues playing the current song.
- To select the previous/next song, press **◀◀ / ▶▶**.
- To cancel scanning, press and hold the volume knob. Playback returns to the channel before you entered TuneScan.
- Pressing any button other than volume knob or **◀◀ / ▶▶** will interrupt scanning and eventually stop scanning.

SiriusXM settings

- 1 Press the volume knob to enter **[FUNCTION]**.
- 2 Turn the volume knob to select an item (see the following table), then press the knob.
- 3 Repeat step 2 until the desired item is selected/activated or follow the instructions stated on the selected item.
- 4 Press and hold **Q / ↵** to exit.

To return to the previous setting item, press **Q / ↵**.

Default: **[XX]**

[SIRIUS XM]

[SEEK MODE]

Selects the tuning method for **◀◀ / ▶▶** buttons when pressed.
[CHANNEL]: Manually search for a channel. ; **[PRESET]**: Search for a preset channel of the selected band. (Automatically search for preset 1 channel if the current channel is not a preset channel.)

[CHANNEL LOCK]

To unlock settings:

- 1 Turn the volume knob to select a number.
- 2 Press **◀◀ / ▶▶** to move to the entry position.
- 3 Repeat step 1 and step 2 to enter the current pass code. (Initial pass code is 0000.)
- 4 Press the volume knob to confirm.

[CODE SET]

- 1 Turn the volume knob to select a number.
 - 2 Press **◀◀ / ▶▶** to move to the entry position.
 - 3 Repeat step 1 and step 2 to enter a new 4-digit pass code.
 - 4 Press the volume knob to confirm.
 - 5 Repeat step 1 to step 4 to reconfirm the pass code.
- Make a note of the new pass code to enter channel lock settings for next time.

[LOCK SETTING]

[MATURE CH]: Selects the SiriusXM-defined lock setting. ;
[USER DEFINED]: Selects the individual channels the user wants to lock. ; **[OFF]**: Cancels.

[CHANNEL EDIT]*1

- 1 Turn the volume knob to select a category, then press the knob.
- 2 Turn the volume knob to select a channel you want to lock, then press the knob.
“L” appears in front of the channel number.
- 3 Press and hold **Q / ↵** to exit.

[CHANNEL CLEAR]*1

[YES]: Clears all the locked channels. ; **[NO]**: Cancels.

[TUNE START]*2

[ON]: All qualified music channels in the SmartFavorites will start playback from the beginning of the song. ; **[OFF]**: Cancels.

[SIGNAL LEVEL]

Shows the strength (**[NO SIGNAL]**)/(**[WEAK]**)/(**[GOOD]**)/(**[STRONG]**) of the current received signal.

[BUFFER USAGE]

Shows the memory usage (**[0%**] to **[100%]**) for Replay buffer.

[SXM RESET]

[YES]: Resets all SiriusXM settings to default. ; **[NO]**: Cancels.

*1 Displayed only when **[LOCK SETTING]** is set to **[USER DEFINED]**.

*2 Available only if the connected SiriusXM Vehicle Tuner is SXV200 or later which supports SmartFavorites.

AUX

You can listen to music from a portable audio player via the auxiliary input jack.

Preparation:

Select [ON] for [BUILT-IN AUX] in [SOURCE SELECT]. (Page 6)

Start listening

- 1 Connect a portable audio player (commercially available).

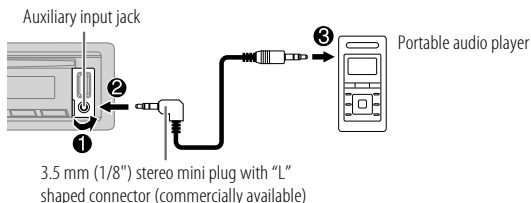

- 2 Press \odot SRC repeatedly to select AUX.
- 3 Turn on the portable audio player and start playback.

Set the name of the external device

While listening to a portable audio player connected to the unit...

- 1 Press the volume knob to enter [FUNCTION].
- 2 Turn the volume knob to select [SYSTEM], then press the knob.
- 3 Turn the volume knob to select [AUX NAME SET], then press the knob.
- 4 Turn the volume knob to select an item, then press the knob.
[AUX] (default)/[DVD]/[PORTABLE]/[GAME]/[VIDEO]/[TV]
- 5 Press and hold \mathcal{R}/\rightarrow to exit.

To return to the previous setting item, press \mathcal{R}/\rightarrow .

KENWOOD Remote Application

You can control the KENWOOD car receiver from iPhone/iPod touch (via Bluetooth or via USB input terminal) or Android device (via Bluetooth) using KENWOOD Remote application.

- For more information, visit <<https://www.kenwood.com/cs/ce/>>.

Preparation:

Install the latest version of KENWOOD Remote application on your device before connecting.

Start using KENWOOD Remote application

- 1 Start up the KENWOOD Remote application on your device.
- 2 Connect your device.
 - For Android device:
Pair the Android device with this unit via Bluetooth. (Page 17)
 - For iPhone/iPod touch:
Connect iPhone/iPod touch to the USB input terminal. (Page 9) (or)
Pair the iPhone/iPod touch with this unit via Bluetooth. (Page 17)
(Make sure the USB input terminal is not connected to any device.)
- 3 Select the device to use from the [FUNCTION] menu.
See the following "Settings to use KENWOOD Remote application".
By default, [ANDROID] is selected. To use iPhone/iPod touch, select [YES] for [IOS].

Settings to use KENWOOD Remote application

- 1 Press the volume knob to enter [FUNCTION].
- 2 Turn the volume knob to select an item (page 16), then press the knob.
- 3 Repeat step 2 until the desired item is selected/activated.
- 4 Press and hold \mathcal{R}/\rightarrow to exit.

To return to the previous setting item, press \mathcal{R}/\rightarrow .

Default: [XX]

[REMOTE APP]	
[SELECT]	Selects the device ([IOS] or [ANDROID]) to use the application.
[IOS]	<p>[YES]: Selects iPhone/iPod touch to use the application via Bluetooth or connected via USB input terminal. ; [NO]: Cancels.</p> <p>If [IOS] is selected, select iPod BT source (or iPod USB source if your iPhone/iPod touch is connected via USB input terminal) to activate the application.</p> <ul style="list-style-type: none"> • See "Set the playable source for iPod/iPhone" on page 10 for further information. • The connectivity of the application will be interrupted or disconnected if: <ul style="list-style-type: none"> – You change from iPod BT source to any playback source connected via the USB input terminal. – You change from iPod USB source to iPod BT source.
[ANDROID]	<p>[YES]: Selects Android device to use the application via Bluetooth. ; [NO]: Cancels.</p>
[ANDROID LIST]	<p>Selects the Android device to use from the list.</p> <ul style="list-style-type: none"> • Displayed only when [ANDROID] of [SELECT] is set to [YES].
[STATUS]	<p>Shows the status of the selected device.</p> <p>[IOS CONNECTED]: You are able to use the application using the iPhone/iPod touch connected via Bluetooth or USB input terminal.</p> <p>[IOS NOT CONNECTED]: No iOS device is connected to use the application.</p> <p>[ANDROID CONNECTED]: You are able to use the application using the Android device connected via Bluetooth.</p> <p>[ANDROID NOT CONNECTED]: No Android device is connected to use the application.</p>

Bluetooth®

- Depending on the Bluetooth version, operating system and the firmware version of your mobile phone, Bluetooth features may not work with this unit.
- Be sure to turn on the Bluetooth function of the device to make the following operations.
- Signal conditions vary depending on the surroundings.

Bluetooth — Connection

Supported Bluetooth profiles

- Hands-Free Profile (HFP)
- Advanced Audio Distribution Profile (A2DP)
- Audio/Video Remote Control Profile (AVRCP)
- Serial Port Profile (SPP)
- Phonebook Access Profile (PBAP)

Supported Bluetooth codecs

- Sub Band Codec (SBC)
- Advanced Audio Coding (AAC)

Connect the microphone

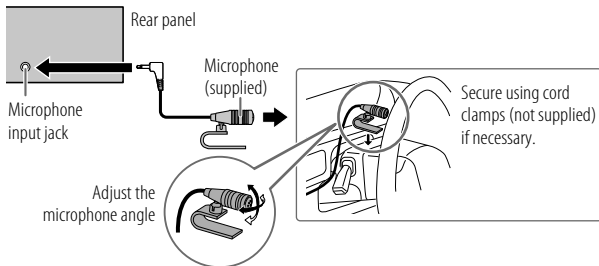

Bluetooth®

Pair and connect a Bluetooth device for the first time

- 1 Press **SRC** to turn on the unit.
- 2 Search and select the name of your receiver ("KDC-BT782HD"/"KDC-X705") on the Bluetooth device.
"PAIRING" → "PASS XXXXXX" → "Device name" → "PRESS" → "VOLUME KNOB" appears on the display.
 - For some Bluetooth devices, you may need to enter the Personal Identification Number (PIN) code immediately after searching.
- 3 Press the volume knob to start pairing.
"PAIRING OK" appears when pairing is completed.

Once pairing is completed, Bluetooth connection is established automatically.

- "BT 1" and/or "BT 2" indicator on the display window lights up.
- "🔋" indicator lights up to show the strength of the battery and signal of the connected device.
- This unit supports Secure Simple Pairing (SSP).
- Up to five devices can be registered (paired) in total.
- Once the pairing is completed, the Bluetooth device will remain registered in the unit even if you reset the unit. To delete the paired device, see [DEVICE DELETE] on page 21.
- A maximum of two Bluetooth phones and one Bluetooth audio device can be connected at any time. To connect or disconnect the registered device, see [PHONE SELECT] or [AUDIO SELECT] in [BT MODE]. (Page 21)
However, while in BT AUDIO source, you can connect to five Bluetooth audio devices and switch between these five devices. (Page 22)
- Some Bluetooth devices may not automatically connect to the unit after pairing. Connect the device to the unit manually.
- Refer to the instruction manual of the Bluetooth device for more information.

Auto Pairing

When you connect iPhone/iPod touch to the USB input terminal, pairing request (via Bluetooth) is automatically activated if [AUTO PAIRING] is set to [ON]. (Page 21)

Press the volume knob to pair once you have confirmed the device name.

Bluetooth — Mobile phone

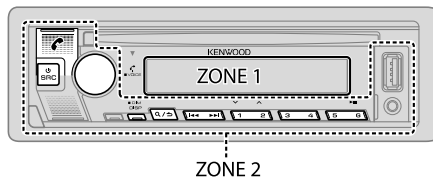

Receive a call

When there is an incoming call:

- [ZONE 2] illuminates in green color and flashes.
- The unit answers the call automatically if [AUTO ANSWER] is set to a selected time. (Page 19)

During a call:

- [ZONE 1] illuminates according to the settings made for [DISPLAY] (page 29) and [ZONE 2] illuminates in green color.
- If you turn off the unit or detach the faceplate, Bluetooth is disconnected.

Bluetooth®

The following operations may differ or be unavailable depending on the connected phone.

To	On the faceplate	On the remote control
First incoming call...		
Answer a call	Press or the volume knob or one of the number buttons (1 to 6).	Press .
Reject a call	Press .	Press .
End a call	Press .	Press .
While talking on the first incoming call...		
Answer another incoming call and hold the current call	Press .	Press .
Reject another incoming call	Press .	Press .
While having two active calls...		
End current call and activate held call	Press .	Press .
Swap between the current call and held call	Press .	Press .
Adjust the phone volume*1 [00] to [35] (Default: [15])	Turn the volume knob during a call.	Press VOL *2 or VOL during a call.
Switch between hands-free and private talk modes*3	Press 6 during a call.	(Not available)

*1 This adjustment will not affect the volume of the other sources.

*2 Press and hold VOL to continuously increase the volume to 15.

*3 Operations may vary according to the connected Bluetooth device.

Improve the voice quality

While talking on the phone...

- 1 Press the volume knob to enter [FUNCTION].
- 2 Turn the volume knob to select an item (see the following table), then press the knob.
- 3 Repeat step 2 until the desired item is selected or activated.
- 4 Press and hold to exit.

To return to the previous setting item, press .



Default: [XX]

[MIC GAIN]	[-10] to [+10] ([-4]): The sensitivity of the microphone increases as the number increases.
[NR LEVEL]	[LEVEL -5] to [LEVEL +5] ([LEVEL 0]): Adjust the noise reduction level until the least noise is being heard during a phone conversation.
[ECHO CANCEL]	[LEVEL -5] to [LEVEL +5] ([LEVEL 0]): Adjust the echo cancellation delay time until the least echo is being heard during a phone conversation.

- Call quality may depend on mobile phone.

Bluetooth®



Make the setting for answering a call

- 1 Press  to enter Bluetooth mode.
- 2 Turn the volume knob to select [SETTINGS], then press the knob.
- 3 Turn the volume knob to select [AUTO ANSWER], then press the knob.
- 4 Turn the volume knob to select the time (in seconds) for the unit to answer the call automatically, then press the knob.
[01] to [30], or select [OFF] to cancel. (Default: [OFF])
- 5 Press and hold  to exit.

To return to the previous setting item, press .

Make a call

You can make a call from the call history, phonebook, or dialing the number. Call by voice is also possible if your mobile phone has the feature.

- 1 Press  to enter Bluetooth mode.
“(First device name)” appears.
 - If two Bluetooth phones are connected, press  again to switch to the other phone.
“(Second device name)” appears.
- 2 Turn the volume knob to select an item (see the following table), then press the knob.
- 3 Repeat step 2 until the desired item is selected/activated or follow the instructions stated on the selected item.
- 4 Press and hold  to exit.

To return to the previous setting item, press .





[CALL HISTORY]

(Applicable only if the phone supports PBAP.)

- 1 Press the volume knob to select a name or a phone number.
 - “I” indicates call received, “O” indicates call made, “M” indicates call missed.
 - Press DISP to change the display category (NUMBER or NAME).
 - “NO DATA” appears if there is no recorded call history or call number.
- 2 Press the volume knob to call.

[PHONE BOOK]

(Applicable only if the phone supports PBAP.)

- 1 Turn the volume knob quickly to enter alphabet search mode (if the phonebook contains many contacts).
The first menu (ABCDEFGHIJK) appears.
 - To go to the other menu (LMNOPQRSTUVWXYZ), press 2  / .
 - To select the desired first letter, turn the volume knob or press  / , then press the knob.
Select “1” to search with numbers and select “*” to search with symbols.
- 2 Turn the volume knob to select a name, then press the knob.
- 3 Turn the volume knob to select a phone number, then press the knob to call.
 - For using phonebook with this unit, make sure to allow access to or transfer from your smartphone. Depending on the connected phone, the process may be different.
 - Contacts are categorized as: HM (home), OF (office), MO (mobile), OT (other), GE (general)
 - This unit can display only non-accent letters. (Accent letters such as “Ú” are shown as “U”.)

Bluetooth®

[NUMBER DIAL]

- 1 Turn the volume knob to select a number (0 to 9) or character (*, #, +).
- 2 Press **◀◀** / **▶▶** to move the entry position.
Repeat step 1 and step 2 until you finish entering the phone number.
- 3 Press the volume knob to call.

(or using the remote control)

- 1 Press the number buttons (0 to 9) to enter the phone number.
- 2 Press **☎** to call.

[VOICE]

Speak the name of the contact you want to call or the voice command to control the phone functions. (See also the following "Make a call using voice recognition".)

[LOW]/[MID]/[FULL]: Shows the strength of the battery.*

[NO SIGNAL]/[LOW]/[MID]/[MAX]: Shows the strength of the current received signal.*

* Functionality depends on the type of the phone used.

■ Make a call using voice recognition

- 1 Press and hold **☎** to activate the voice recognition of the connected phone.
- 2 Speak the name of the contact you want to call or the voice command to control the phone functions.

• Supported Voice Recognition features vary for each phone. Refer to the instruction manual of the connected phone for details.

Store a contact in memory

You can store up to 6 contacts into the number buttons (1 to 6).

- 1 Press **☎** to enter Bluetooth mode.
- 2 Turn the volume knob to select [CALL HISTORY], [PHONE BOOK] or [NUMBER DIAL], then press the knob.
- 3 Turn the volume knob to select a contact or enter a phone number.
If a contact is selected, press the volume knob to show the phone number.
- 4 Press and hold one of the number buttons (1 to 6).
"STORED" appears when the contact is stored.

To erase a contact from the preset memory, select [NUMBER DIAL] in step 2, store a blank number in step 3 and proceed to step 4.

Make a call to a registered number

- 1 Press **☎** to enter Bluetooth mode.
- 2 Press one of the number buttons (1 to 6).
- 3 Press the volume knob to call.
"NO MEMORY" appears if there is no contact stored.

Bluetooth mode settings

- 1 Press the volume knob to enter [FUNCTION].
- 2 Turn the volume knob to select an item (page 21), then press the knob.
- 3 Repeat step 2 until the desired item is selected/activated or follow the instructions stated on the selected item.
- 4 Press and hold **Q/↵** to exit.

To return to the previous setting item, press **Q/↵**.

Default: [XX]

[BT MODE]	
[PHONE SELECT]	Selects the phone or audio device to connect or disconnect. “✳” appears in front of the device name when connected.
[AUDIO SELECT]	“▷” appears in front of the current playback audio device. • You can connect a maximum of two Bluetooth phones and one Bluetooth audio device at a time.
[DEVICE DELETE]	1 Turn the volume knob to select a device to delete, then press the knob. 2 Turn the volume knob to select [YES] or [NO], then press the knob.
[PIN CODE EDIT] (0000)	Changes the PIN code (up to 6 digits). 1 Turn the volume knob to select a number. 2 Press ◀◀ / ▶▶ to move the entry position. Repeat step 1 and step 2 until you finish entering the PIN code. 3 Press the volume knob to confirm.
[RECONNECT]	[ON]: The unit is automatically reconnect when the last connected Bluetooth device is within the connectable range. ; [OFF]: Cancels.
[AUTO PAIRING]	[ON]: The unit is automatically paired with the supported Bluetooth device (iPhone/iPod touch) when it is connected through USB input terminal. Depending on the operating system of the connected device, this function may not work. ; [OFF]: Cancels.
[INITIALIZE]	[YES]: Initializes all the Bluetooth settings (including stored pairing, phonebook, and etc.). ; [NO]: Cancels.

Bluetooth test mode

You can check the connectivity of the supported profile between the Bluetooth device and the unit.

- Make sure there is no Bluetooth device paired.

- 1 Press and hold .
“PLEASE PAIR YOUR PHONE PIN 0000” appears on the display.
- 2 Search and select the name of your receiver (“KDC-BT782HD”/“KDC-X705”) on the Bluetooth device.
- 3 Operate the Bluetooth device to confirm pairing.
“TESTING” flashes on the display.

The connectivity result (OK or NG) appears after the test.

PAIRING: Pairing status

HF CNT: Hands-Free Profile (HFP) compatibility

AUD CNT: Advanced Audio Distribution Profile (A2DP) compatibility

PB DL: Phonebook Access profile (PBAP) compatibility

To cancel test mode, press and hold  SRC to turn off the unit.

Bluetooth®

Bluetooth — Audio

- Operations and display indications may differ according to their availability on the connected device.
- Depending on the connected device, some features may not work with your device.

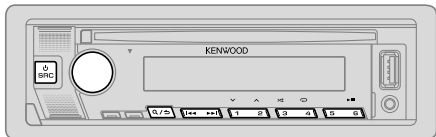

While in BT AUDIO source, you can connect to five Bluetooth audio devices and switch between these five devices.

Listen to the audio player via Bluetooth

- 1 Press SRC repeatedly to select BT AUDIO.
- 2 Operate the audio player via Bluetooth to start playback.

To	On the faceplate	On the remote control
Play back/pause	Press 6	Press ENT
Select group or folder	Press 2 / 1	Press #FM+/*AM-.
Reverse skip/Forward skip	Press /	Press / (+).
Reverse/Fast-forward	Press and hold /	Press and hold / (+).

To	On the faceplate
Repeat play	Press 4 repeatedly. [ALL REPEAT], [FILE REPEAT], [GROUP REPEAT], [REPEAT OFF]
Random play	Press and hold 3 to select [ALL RANDOM] or [GROUP RANDOM]. • Press 3 to select [RANDOM OFF].
Select a file from a folder/ list	Refer to “Select a file to play” on page 11.
Switch between connected Bluetooth audio devices	Press 5. (Pressing the “Play” key on the connected device itself also causes switching of sound output from the device.)

Listen to iPod/iPhone via Bluetooth

You can listen to the songs on the iPod/iPhone via Bluetooth on this unit.

Press SRC repeatedly to select iPod BT.

- You can operate the iPod/iPhone in the same way as iPod/iPhone via USB input terminal. (Page 9)
- See “Set the playable source for iPod/iPhone” on page 10 for further information.

AMAZON ALEXA

Alexa is the cloud-based voice service developed by Amazon. You can ask Alexa to play music, get weather reports, traffic information, control smart home devices, shop on Amazon, search the internet, set reminders and more.

Preparation:

- Create an account at <www.amazon.com>.
- Install the latest version of the Alexa mobile application on your device (iPhone/iPod touch or Android device), then log in to the application.
- Be sure to enable the internet connection on your smartphone.

Setup for the first time

For Android device

- 1 Pair your device with this unit via Bluetooth.** (Page 17)
- 2 Start up the Alexa mobile application on your device.**
- 3 Pair this unit to Alexa mobile application.**
Perform Option A or Option B.

For iPhone/iPod touch

- 1 Pair your device with this unit via Bluetooth.** (Page 17)
- 2 Start up the Alexa mobile application on your device.**
- 3 Press \circ on the unit to enter ALEXA source.**
 - You may also press \circ SRC repeatedly to select iPod BT source.
 - See "Set the playable source for iPod/iPhone" on page 10 for further information.
- 4 Pair this unit to Alexa mobile application.**
Perform Option A or Option B.

Option A: Direct Link

Access the following URL or scan the QR code with your smartphone:

<https://www.kenwood.com/car/alexa>



Option B: Manual Pairing

- 1 Start up the Alexa mobile application and go to the "Devices" tab.**
- 2 Tap the "+" icon at the top right corner.**
- 3 Tap "Add Device".**
- 4 Tap "Automotive Accessory" or "Headphones" from the list of device types.**
- 5 Tap the name of your receiver ("KDC-BT782HD"/"KDC-X705") and follow the instructions.**

Once the setup process is completed, the Alexa mobile application will establish a connection with this unit.

- The Alexa connection can be disconnected if:
 - A2DP profile is disconnected
 - Bluetooth is disconnected
 - This unit is turned off
 - Stop Alexa mobile application running in foreground/background of your device
 - Any other conditions depending on the connected deviceTo establish Alexa connection again, reconnect the A2DP profile.
- Alexa connection cannot be established again if you:
 - Reinstall Alexa mobile application
 - Delete the paired device and perform pairing again (for Android device)To establish Alexa connection again, perform the setup process again.
- You can check the Alexa connection from the Alexa mobile application. If the name of this unit appears on the screen of "ALL DEVICES", you do not need to perform setup process again.

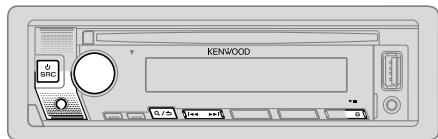

Basic operations

For Alexa supported languages, see page 34 for more information. Some of the languages listed will be available by updating firmware of this unit when new release of firmware is available.

To update the firmware, see page 6 for more information.

Once Alexa connection is established...

- 1 Speak the word "Alexa" to the connected microphone (Page 16) to activate Alexa.

(or)

Press **O** on the unit to speak with Alexa.

The display shows: "ALEXA" → "LISTENING...".

Alexa cannot be activated by voice if:

- Alexa mobile application is not activated.
- Microphone is turned off, "Ø" indicator lights up.
See the following "Turn on/off microphone".
- Current playback source is iPod USB.
- While using Bluetooth phone features.

- 2 Communicate with Alexa via the connected microphone. (Page 16)

"THINKING..." appears when Alexa is processing your voice input.

"SPEAKING..." appears while Alexa is responding to your voice input.

"ALEXA" or display information such as playing time, song title, etc.

appears while Alexa is in idle state.

- To return to the previous source before ALEXA, press **SRC**.
- To activate Alexa, press **O** or speak "Alexa".
- To cancel current listening state, press **O**.
- To cancel current thinking/speaking states and go to listening state, press **O** or speak "Alexa".
- Only one Alexa connection can be connected at one time.
- "DOWNLOAD" → "ALEXA APP" → "AND PAIR" → "BLUETOOTH" → "TO USE ALEXA" appear if the unit is disconnected from Alexa mobile application or the Bluetooth connection is disconnected.
- Alexa will be ready to listen to the wake word after reconnected.

Turn on/off microphone

Press and hold **O** to turn on and turn off the microphone.

- "Ø" indicator lights up when the microphone is turned off.
- You cannot perform this operation while using Bluetooth phone features.

AMAZON ALEXA

Start listening

While in Alexa idle state...

- 1 Speak the word "Alexa" to the connected microphone (Page 16) to activate Alexa.
(or)
Press **O** on the unit to speak with Alexa.
The display shows: "LISTENING...".
- 2 Communicate with Alexa via the connected microphone.
- 3 During music playback in ALEXA source, you can perform the following operations:

To	On the faceplate	On the remote control
Play back/pause	Press 6 ► .	Press ENT ► .
Reverse skip/Forward skip	Press I◀◀/▶▶I.	Press I◀◀/▶▶I (+).

During music playback, press **O** or speak "Alexa" to pause the music and activate Alexa. You can now start to communicate with Alexa.

Audio Settings

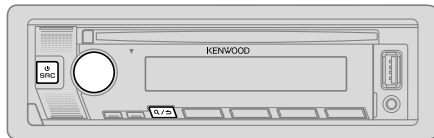

- 1 Press the volume knob to enter [FUNCTION].
- 2 Turn the volume knob to select an item (see the following table), then press the knob.
- 3 Repeat step 2 until the desired item is selected/activated.
- 4 Press and hold **Q/↵** to exit.

(or using the remote control)

- 1 Press AUD to enter [AUDIO CONTROL].
- 2 Press **▲/▼** to select an item, then press ENT ►||.

To return to the previous setting item, press **Q/↵**.

Default: [XX]

[AUDIO CONTROL]	
[SUB-W LEVEL]	[LEVEL -50] to [LEVEL +10] ([LEVEL 0]): Adjusts the subwoofer output level.
[EASY EQ]	Adjusts your own sound settings. <ul style="list-style-type: none">• The settings are stored to [USER] in [PRESET EQ].• The settings made may affect the current settings of [MANUAL EQ].
[SW]:	[LEVEL -50] to [LEVEL +10] (Default: [LEVEL 0])
[BASS]:	[LEVEL -9] to [LEVEL +9] [LEVEL 0]
[MID]:	[LEVEL -9] to [LEVEL +9] [LEVEL 0]
[TRE]:	[LEVEL -9] to [LEVEL +9] [LEVEL 0]

Audio Settings

[MANUAL EQ]	Adjusts your own sound settings for each source. • The settings are stored to [USER] in [PRESET EQ]. • The settings made may affect the current settings of [EASY EQ].	
[62.5HZ]	[LEVEL]	[LEVEL -9] to [LEVEL +9] ([LEVEL 0]): Adjusts the level to memorize for each source. (Before making an adjustment, select the source you want to adjust.)
	[BASS EXTEND]	[ON]: Turns on the extended bass. ; [OFF]: Cancels.
[100HZ]/[160HZ]/ [250HZ]/[400HZ]/ [630HZ]/[1KHZ]/ [1.6KHZ]/[2.5KHZ]/ [4KHZ]/[6.3KHZ]/ [10KHZ]/[16KHZ]	[LEVEL -9] to [LEVEL +9] ([LEVEL 0]):	Adjusts the level to memorize for each source. (Before making an adjustment, select the source you want to adjust.)
[Q FACTOR]	[1.35]/[1.50]/[2.00]:	Adjusts the quality factor.
[PRESET EQ]	[NATURAL]/[ROCK]/[POPS]/[EASY]/[TOP40]/[JAZZ]/[POWERFUL]/ [USER]: Selects a preset equalizer suitable to the music genre. (Select [USER] to use the settings made in [EASY EQ] or [MANUAL EQ].)	
[BASS BOOST]	[LV1] to [LV5]:	Selects your preferred bass boost level. ; [OFF]: Cancels.
[LOUDNESS]	[LV1]/[LV2]:	Selects your preferred low or high frequencies boost to produce a well-balanced sound at low volume. ; [OFF]: Cancels.
[SUBWOOFER SET]	[ON]:	Turns on the subwoofer output. ; [OFF]: Cancels.
[FADER]	[R15] to [F15] ([0]):	Adjusts the front and rear speaker output balance.
[BALANCE]	[L15] to [R15] ([0]):	Adjusts the left and right speaker output balance.
[VOLUME OFFSET]	[-15] to [+6] ([0]):	Presets the initial volume level of each source by comparing to the FM volume level. (Before adjustment, select the source you want to adjust.)

[SOUND EFFECT]		
[SOUND RECNSTR]	(Not applicable for HD RADIO source, AUX source and SIRIUS XM source.) (Sound reconstruction)	[ON]: Creates realistic sound by compensating the high-frequency components and restoring the rise-time of the waveform that are lost in audio data compression. ; [OFF]: Cancels.
[SPACE ENHANCE]	(Not applicable for HD RADIO source.)	[SML]/[MED]/[LRG]: Virtually enhances the sound space. ; [OFF]: Cancels.
[SND REALIZER]	[LV1]/[LV2]/[LV3]:	Virtually makes the sound more realistic. ; [OFF]: Cancels.
[STAGE EQ]	[LOW]/[MID]/[HI]:	Virtually adjusts the sound position heard from the speakers. ; [OFF]: Cancels.
[DRIVE EQ]	[ON]:	Boosts the frequency to reduce the noise heard from outside the car or running noise of the tyres. ; [OFF]: Cancels.
[SPEAKER SIZE]	The frequency and slope settings are automatically set for the crossover of the selected speaker.	
[FRONT]	[SIZE]	[3.5"]/[4"]/[4.75"]/[5"]/[6.5"]/[6.75"]/[7"]/[4×6]/ [5×7]/[6×8]/[6×9]/[7×10]: Selects according to the connected speaker size for optimum performance.
	[TWEETER]	[SMALL]/[MIDDLE]/[LARGE]: Selects according to the size range of the connected tweeter for optimum performance. ; [NONE]: Not connected.
[REAR]	[3.5"]/[4"]/[4.75"]/[5"]/[6.5"]/[6.75"]/[7"]/[4×6]/[5×7]/[6×8]/ [6×9]/[7×10]:	Selects according to the connected speaker size for optimum performance. ; [NONE]: Not connected.
[SUBWOOFER]	[6.5"]/[8"]/[10"]/[12"]/[15" OVER]:	Selects according to the connected speaker size for optimum performance. ; [NONE]: Not connected.

Audio Settings

[X ' OVER]		
[TWEETER]	[FRQ]	[1KHZ]/[1.6KHZ]/[2.5KHZ]/[4KHZ]/[5KHZ]/[6.3KHZ]/[8KHZ]/[10KHZ]/[12.5KHZ]: Adjusts the crossover frequency for the tweeter speaker.
	[GAIN LEFT]	[−8] to [0]: Adjusts the output volume of the left tweeter.
	[GAIN RIGHT]	[−8] to [0]: Adjusts the output volume of the right tweeter.
[FRONT HPF]	[F-HPF FRQ]	[30HZ]/[40HZ]/[50HZ]/[60HZ]/[70HZ]/[80HZ]/[90HZ]/[100HZ]/[120HZ]/[150HZ]/[180HZ]/[220HZ]/[250HZ]: Adjusts the crossover frequency for the selected speakers (high pass filter). ; [THROUGH]: All signals are sent to the selected speakers.
	[F-HPF SLOPE]	[−6DB]/[−12DB]/[−18DB]/[−24DB]: Adjusts the crossover slope. (Selectable only if a setting other than [THROUGH] is selected for [F - HPF FRQ].)
	[F-HPF GAIN]	[−8] to [0]: Adjusts the output volume of the selected speaker.
	[REAR HPF]	[R-HPF FRQ] [R-HPF SLOPE] [R-HPF GAIN]
[SUBWOOFER LPF]	[SW LPF FRQ]	[30HZ]/[40HZ]/[50HZ]/[60HZ]/[70HZ]/[80HZ]/[90HZ]/[100HZ]/[120HZ]/[150HZ]/[180HZ]/[220HZ]/[250HZ]: Adjusts the crossover frequency for the subwoofer (low pass filter). ; [THROUGH]: All signals are sent to the subwoofer.
	[SW LPF SLOPE]	[−6DB]/[−12DB]/[−18DB]/[−24DB]: Adjusts the crossover slope. (Selectable only if a setting other than [THROUGH] is selected for [SW LPF FRQ].)
	[SW LPF PHASE]	[REVERSE] (180°)/[NORMAL] (0°): Selects the phase of the subwoofer output to be in line with the speaker output for optimum performance.
	[SW LPF GAIN]	[−8] to [0]: Adjusts the output volume of the subwoofer.
[DTA SETTINGS] For settings, see “Digital Time Alignment settings” on page 28.		
[CAR SETTINGS]		

- The following item is selectable only if [SUBWOOFER SET] is set to [ON] (page 26):
 - [SUB-W LEVEL]
 - [SW LEVEL] of [EASY EQ]
 - [SUBWOOFER] of [SPEAKER SIZE]
 - [SUBWOOFER LPF] of [X ' OVER]
 - [SUBWOOFER] of [DISTANCE] and [GAIN] in [DTA SETTINGS]
- The following item is selectable only if a setting other than [NONE] is selected for [TWEETER], [REAR] and [SUBWOOFER] of [SPEAKER SIZE] (page 26):
 - [TWEETER], [REAR HPF], [SUBWOOFER LPF] of [X ' OVER]

Audio Settings

Digital Time Alignment settings

Digital Time Alignment sets the delay time of the speaker output to create a more suitable environment for your vehicle.

- For more information, see the following “Determining the delay time automatically”.

[DTA SETTINGS]	
[POSITION]	Selects your listening position (reference point). [ALL]: Not compensating ; [FRONT RIGHT]: Front right seat ; [FRONT LEFT]: Front left seat ; [FRONT ALL]: Front seats
[DISTANCE]	[0FT] to [20.01FT]: Fine adjust the distance to compensate. (Before making an adjustment, select the speaker you want to adjust.)
[GAIN]	[-8DB] to [0DB]: Fine adjust the output volume of the selected speaker. (Before making an adjustment, select the speaker you want to adjust.)
[DTA RESET]	[YES]: Resets the settings ([DISTANCE] and [GAIN]) of the selected [POSITION] to default. ; [NO]: Cancels.
[CAR SETTINGS]	Identify your car type and rear speaker location in order to make the adjustment for [DTA SETTINGS].
[CAR TYPE]	[COMPACT]/[FULL SIZE CAR]/[WAGON]/[MINIVAN]/[SUV]/ [MINIVAN(LONG)]: Selects the type of vehicle. ; [OFF]: Not compensating.
[R-SP LOCATION]	Selects the location of the rear speakers in your vehicle to calculate the furthest distance from the listening position selected (reference point). <ul style="list-style-type: none">[DOOR]/[REAR DECK]: Selectable only when [CAR TYPE] is selected as [OFF], [COMPACT], [FULL SIZE CAR], [WAGON] or [SUV].[2ND ROW]/[3RD ROW]: Selectable only when [CAR TYPE] is selected as [MINIVAN] or [MINIVAN(LONG)].

- Before making an adjustment for [DISTANCE] and [GAIN] of [DTA SETTINGS], select the speaker you want to adjust:
[FRONT LEFT]/[FRONT RIGHT]/[REAR LEFT]/[REAR RIGHT]/[SUBWOOFER]
 - You can only select [REAR LEFT], [REAR RIGHT] and [SUBWOOFER] if a setting other than [NONE] is selected for [REAR] and [SUBWOOFER] of [SPEAKER SIZE]. (Page 26)
- [R-SP LOCATION] of [CAR SETTING] is selectable only if a setting other than [NONE] is selected for [REAR] of [SPEAKER SIZE]. (Page 26)

Determining the delay time automatically

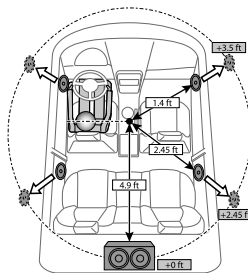

If you specify the distance from the currently set listening position to every speaker, the delay time will be automatically calculated.

- Set [POSITION] and determine the listening position as the reference point (the reference point for [FRONT ALL] will be the center between the right and left in the front seats).
- Measure the distances from the reference point to the speakers.
- Calculate the distance between the furthest speaker (subwoofer on the illustration) and other speakers.
- Set the [DISTANCE] calculated in step 3 for individual speakers.
- Adjusts [GAIN] for individual speakers.

Example: When [FRONT ALL] is selected as the listening position.

Display Settings

Zone identification for color settings and brightness settings

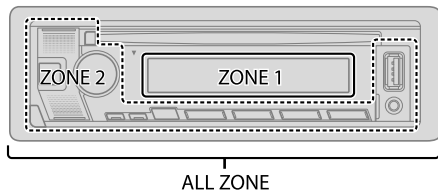

Set the dimmer

Press and hold DISP (DIM) to turn on or off the dimmer.

- Once you press and hold this button, [DIMMER] setting will be overwritten.

Change the display settings

- Press the volume knob to enter [FUNCTION].
- Turn the volume knob to select an item (see the following table), then press the knob.
- Repeat step 2 until the desired item is selected/activated or follow the instructions stated on the selected item.
- Press and hold **Q/S** to exit.

To return to the previous setting item, press **Q/S**.

Default: [XX]

[DISPLAY]

[COLOR SELECT] Selects illumination colors for [ALL ZONE], [ZONE 1] and [ZONE 2] separately.

- Select a zone. (See the illustration on left column.)
- Select a preset color for the selected zone. (Page 34)
Default: [VARIABLE SCAN]

To make your own color, select [CUSTOM R/G/B]. The color you have made will be stored in [CUSTOM R/G/B].

- Press the volume knob to enter the detailed color adjustment.
- Press **◀/▶** to select the color ([R]/[G]/[B]) to adjust.
- Turn the volume knob to adjust the level ([0] to [9]), then press the knob.

[DIMMER]

Dims the illumination.

[ON]: Dimmer is turned on.

[OFF]: Dimmer is turned off.

[DIMMER TIME]: Set the time to turn on dimmer and to turn off dimmer.

- Turn the volume knob to adjust the [ON] time, then press the knob.
- Turn the volume knob to adjust the [OFF] time, then press the knob.
Default: [ON]: [6:00PM] ; [OFF]: [6:00AM]

[BRIGHTNESS]

Sets the brightness for day and night separately.

- [DAY]/[NIGHT]: Select day or night.
- Select a zone. (See the illustration on left column.)
- [LVL00] to [LVL31]: Set the brightness level.

[TEXT SCROLL]

[ONCE]: Scrolls the display information once. ; [AUTO]: Repeats scrolling at 5-second intervals. ; [OFF]: Cancels.

[CLOCK]

[CLOCK DISPLAY] [ON]: The clock time is shown on the display even when the unit is turned off. ; [OFF]: Cancels.

[DEMO MODE]

[ON]: Activates the display demonstration automatically if no operation is done for about 15 seconds. ; [OFF]: Deactivates.

Installation/Connection

This section is for the professional installer.
For safety's sake, leave wiring and mounting to professionals. Consult the car audio dealer.

▲ WARNING

- The unit can only be used with a 12 V DC power supply, negative ground.
- Disconnect the battery's negative terminal before wiring and mounting.
- Do not connect Battery wire (yellow) and Ignition wire (red) to the car chassis or Ground wire (black) to prevent a short circuit.
- To prevent short circuit:
 - Insulate unconnected wires with vinyl tape.
 - Be sure to ground this unit to the car's chassis again after installation.
 - Secure the wires with cable clamps and wrap vinyl tape around the wires that comes into contact with metal parts to protect the wires.

▲ CAUTION

- Install this unit in the console of your vehicle. Do not touch the metal parts of this unit during and shortly after use of the unit. Metal parts such as the heat sink and enclosure become hot.
- Do not connect the ⊖ wires of speakers to the car chassis or Ground wire (black), or connect them in parallel.
- Mount the unit at an angle of less than 30°.
- If your vehicle wiring harness does not have the ignition terminal, connect Ignition wire (red) to the terminal on the vehicle's fuse box which provides 12 V DC power supply and is turned on and off by the ignition key.
- Keep all cables away from heat dissipate metal parts.
- After the unit is installed, check whether the brake lamps, blinkers, wipers, etc. on the car are working properly.
- If the fuse blows, first make sure the wires are not touching car's chassis, then replace the old fuse with one that has the same rating.

Part list for installation

(A) Faceplate (×1)



(C) Mounting sleeve (×1)

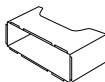

(E) Extraction key (×2)



(B) Trim plate (×1)



(D) Wiring harness (×1)

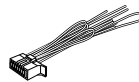

(F) Screws

 M5 × 7 mm (×4)

 M5 × 6 mm (×4)

 M4 × 8 mm (×1)

Basic procedure

- 1 Remove the key from the ignition switch, then disconnect the ⊖ terminal of the car battery.
- 2 Connect the wires properly.
See "Wiring connection" on page 32.
- 3 Install the unit to your car.
See "Installing the unit (in-dash mounting)" on page 31.
- 4 Connect the ⊖ terminal of the car battery.
- 5 Press  SRC to turn on the power.
- 6 Detach the faceplate and reset the unit within 5 seconds. (Page 4)

Installation/Connection

Installing the unit (in-dash mounting)

1

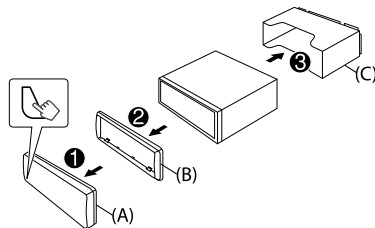

2

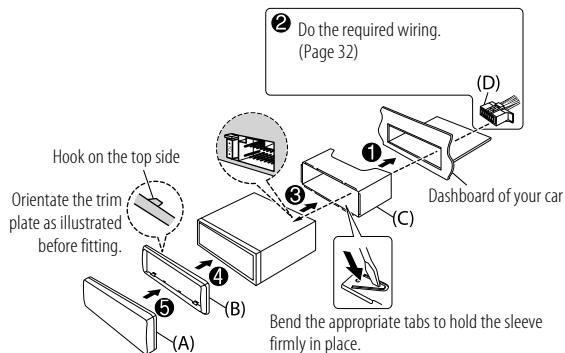

Installing the unit (without mounting sleeve)

- 1 Remove the mounting sleeve and trim plate from the unit.
- 2 Align the holes in the unit (on both sides) with the vehicle mounting bracket and secure the unit with supplied screws.

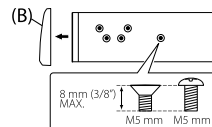

▲ Use only the specified screws. Using wrong screws might damage the unit.

Removing the unit

- 1 Detach the faceplate.
- 2 Fit the catch pin on the extraction keys into the holes on both sides of the trim plate, then pull it out.
- 3 Insert the extraction keys deeply into the slots on each side, then follow the arrows as shown on the illustration.

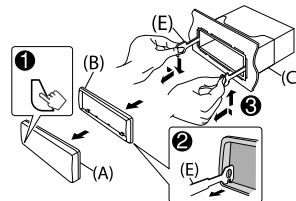

Installation/Connection

Wiring connection

IMPORTANT

We recommend installing the unit with a commercially available custom wiring harness specific for your car and leave this job to professionals for your safety. Consult your car audio dealer.

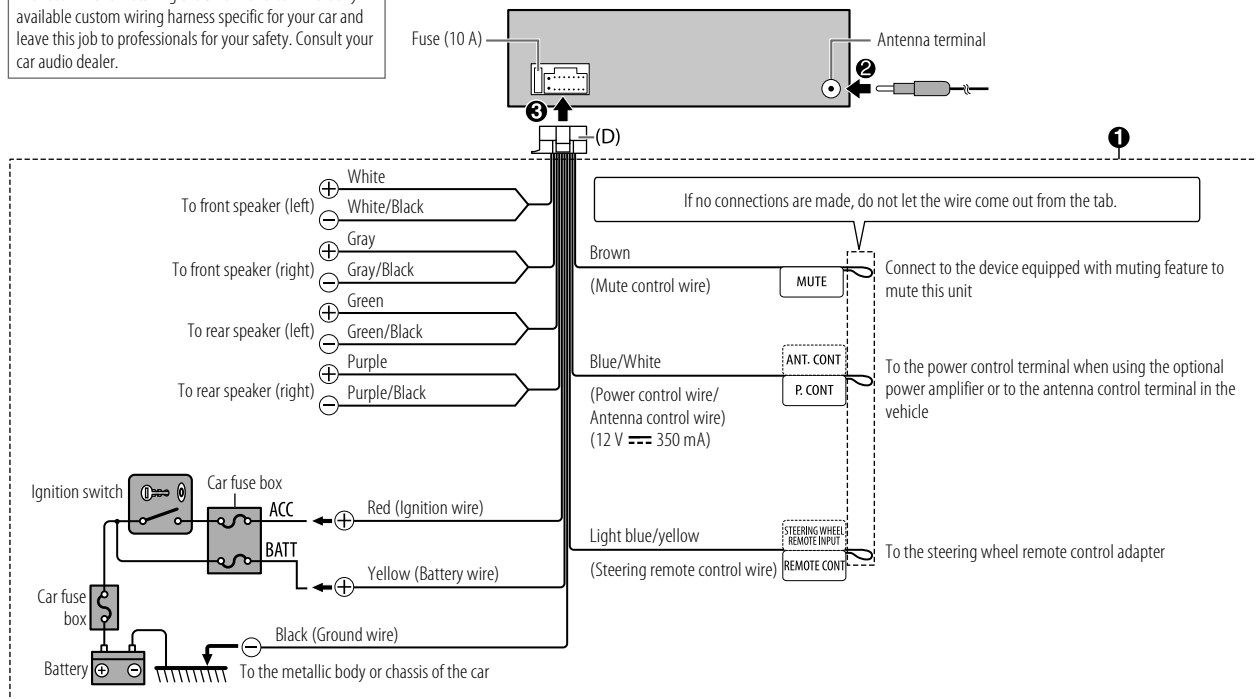

Installation/Connection

Connect external components

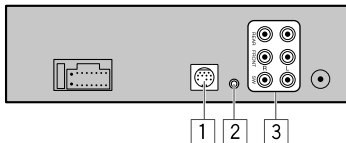

No	Part
1	Expansion port (12 V DC 500 mA): To the optional SiriusXM Vehicle Tuner (commercially available) (Page 12)
2	Microphone input jack (Page 16)
3	Output terminals REAR: Rear output FRONT: Front output SW: Subwoofer output <ul style="list-style-type: none">When connecting an external amplifier to the output terminals of this unit, securely connect the amplifier ground wire to the car chassis to prevent damage to the unit.

References

Maintenance

Cleaning the unit

Wipe off dirt on the faceplate with a dry silicone or soft cloth.

Cleaning the connector

Detach the faceplate and clean the connector gently with a cotton swab. Be careful not to damage the connector.



Connector (on the reverse side of the faceplate)

Handling discs

- Do not touch the recording surface of the disc.
- Do not stick tape etc. on the disc, or use a disc with tape stuck on it.
- Do not use any accessories for the disc.
- Clean from the center of the disc and move outward.
- Clean the disc with a dry silicone or soft cloth. Do not use any solvents.
- When removing a disc from this unit, pull it out horizontally.
- Remove burrs from the center hole and disc edge before inserting a disc.

More information

- For:
- Latest firmware updates and latest compatible item list
 - KENWOOD original application
 - Any other latest information

Visit <https://www.kenwood.com/cs/ce/>.

General

- This unit can only play the following CDs:



- For detailed information and notes about the playable audio files, visit <https://www.kenwood.com/cs/ce/audiofile/>.

References

Playable files

- Disc:
Playable audio file:
MP3 (.mp3), WMA (.wma), AAC (.aac)
Playable media: CD-R/CD-RW/CD-ROM
Playable file format: ISO 9660 Level 1/2, Joliet, Long file name
- USB mass storage class device:
Playable audio file:
MP3 (.mp3), WMA (.wma), AAC (.aac), AAC (.m4a), WAV (.wav), FLAC (.flac)
Playable file system: FAT12, FAT16, FAT32

Even when audio files comply with the standards listed above, playback may be impossible depending on the types or conditions of media or devices.
The AAC (.m4a) file in a CD encoded by iTunes cannot be played on this unit.

Unplayable discs

- Discs that are not round.
- Discs with coloring on the recording surface or discs that are dirty.
- Recordable/ReWritable discs that have not been finalized.
- 8 cm CD. Attempting to insert using an adapter may cause malfunction.

About USB devices

- You cannot connect a USB device via a USB hub.
- Connecting a cable whose total length is longer than 5 m may result in abnormal playback.
- This unit cannot recognize a USB device whose rating is other than 5 V and exceeds 1.5 A.

About iPod/iPhone

- Made for
 - iPod touch (6th generation)
 - iPhone 5S, 6, 6 Plus, 6S, 6S Plus, SE, 7, 7 Plus, 8, 8 Plus, X, XS, XS MAX, XR, 11, 11 Pro, 11 Pro MAX, SE (2nd generation), 12, 12 Mini, 12 Pro, 12 Pro MAX
- The song order displayed on the selection menu of this unit may differ from that of the iPod/iPhone.
- Depending on the version of the operating system of the iPod/iPhone, some functions may not operate on this unit.

About AMAZON ALEXA

- Alexa is a third party service, therefore the specifications are subject to change without prior notice. Accordingly, compatibility may be impaired or some or all of the services may become unavailable.
- Alexa supported languages on this unit: US English/Canada English/US Spanish/Canada French/Mexico Spanish/UK English/Italy Italian/Spain Spanish/France French/Deutschland Deutsch/Australia English/Japan Japanese

Preset color

[INITIAL COLOR]/[VARIABLE SCAN]/[CUSTOM R/G/B]/[RED1]/[RED2]/[RED3]/[PURPLE1]/[PURPLE2]/[PURPLE3]/[PURPLE4]/[BLUE1]/[BLUE2]/[BLUE3]/[SKYBLUE1]/[SKYBLUE2]/[LIGHTBLUE]/[AQUA1]/[AQUA2]/[GREEN1]/[GREEN2]/[GREEN3]/[YELLOWGREEN1]/[YELLOWGREEN2]/[YELLOW]/[ORANGE1]/[ORANGE2]/[ORANGERED]

About HD Radio™ Technology

- HD2/HD3** • Adjacent to traditional main stations are extra local FM channels. These HD2/HD3 Channels provide new, original music as well as deep cuts into traditional genre.
- Digital Sound** • Digital, CD-quality sound. HD Radio Technology enables local radio stations to broadcast a clean digital signal. AM sounds like today's FM and FM sounds like a CD.
- Program Info** • Program Info provides song name, artist, station ID, and other relevant data to enrich the listening experience.
- Emergency Alerts** • Emergency Alert delivers critical and life-saving messages to the public during emergency situations.

References

Change the display information

Each time you press DISP, the display information changes.

- If the information is unavailable or not recorded, "NO TEXT", "NO INFO", or other information (eg. station name) appears or display will be blank.

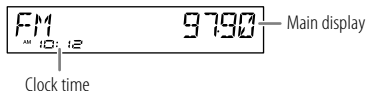



Source name	Display information: Main display
STANDBY	Source name → Date → back to the beginning
HD RADIO	For digital stations only: Station name → Title/Artist → Album/Artist → Frequency → Date → back to the beginning
	For FM Radio Broadcast Data System stations only: Radio text+ station name → Radio text+ title/Radio text+ artist → Radio text+ album/Radio text+ artist → Frequency → Date → back to the beginning
CD or USB	For CD-DA: Disc title/Artist → Track title/Artist → Playing time → Date → back to the beginning
	For MP3/WMA/AAC/WAV/FLAC files: Song title/Artist → Album title/Artist → Folder name → File name → Playing time → Date → back to the beginning

Source name	Display information: Main display
iPod USB/iPod BT	Song title/Artist → Album title/Artist → Playing time → Date → back to the beginning
SIRIUS XM	Channel number → Channel name → Artist → Song title → Content information → Category name → Date → back to the beginning
BT AUDIO/ALEXA	Song title/Artist → Album title/Artist → Playing time → Date → back to the beginning
AUX	Source name → Date → back to the beginning

Troubleshooting

	Symptom	Remedy
General	Sound cannot be heard.	<ul style="list-style-type: none"> Adjust the volume to the optimum level. Check the cords and connections.
	"MISWIRING CHECK WIRING THEN PWR ON" appears.	Turn the power off, then check to be sure the terminals of the speaker wires are insulated properly. Turn the power on again.
	"PROTECTING SEND SERVICE" appears.	Send the unit to the nearest service center.
	Source cannot be selected.	Check the [SOURCE SELECT] setting. (Page 6)
	<ul style="list-style-type: none"> Sound cannot be heard. The unit does not turn on. Information shown on the display is incorrect. 	Clean the connectors. (Page 33)
	The unit does not work at all.	Reset the unit. (Page 4)
HD Radio Tuner	Correct characters are not displayed.	<ul style="list-style-type: none"> This unit can only display uppercase letters, numbers, and a limited number of symbols. Depending on the display language you have selected (page 6), some characters may not be displayed correctly.
	<ul style="list-style-type: none"> Radio reception is poor. Static noise while listening to the radio. 	Connect the antenna firmly.
CD/USB/iPod	Disc cannot be ejected.	Press and hold  to forcibly eject the disc. Be careful not to drop the disc when it is ejected. If this does not solve the problem, reset the unit (page 4).
	Noise is generated.	Skip to another track or change the disc.
	"PLEASE EJECT" appears.	Reset the unit (page 4). If this does not solve the problem, consult your nearest service center.

	Symptom	Remedy
CD/USB/iPod	Playback order is not as intended.	Optical disc, the files are played in the order which they were recorded. USB device, the folders are played in the order of creation (date and time). The files within each folder are played in the order of the file name (alphabet).
	Elapsed playing time is not correct.	This depends on the recording process earlier (disc/USB).
	"READING" keeps flashing.	<ul style="list-style-type: none"> Do not use too many hierarchical levels and folders. Reload the disc or reattach the device (USB/iPod/iPhone).
	"UNSUPPORTED DEVICE" appears.	<ul style="list-style-type: none"> Check whether the connected USB device is compatible with this unit and ensure the file systems are in supported formats. (Page 33, 34) Reattach the USB device.
	"UNRESPONSIVE DEVICE" appears.	Make sure the USB device is not malfunction and reattach the USB device.
	"USB HUB IS NOT SUPPORTED" appears.	This unit cannot support a USB device connected via a USB hub.
	<ul style="list-style-type: none"> The source does not change to "USB" when you connect a USB device while listening to another source. "USB ERROR" appears. 	The USB port is drawing more power than the design limit. Turn the power off and unplug the USB device. Then, turn on the power and reattach the USB device. If this does not solve the problem, turn the power off and on (or reset the unit) before replacing with another USB device.
	The iPod/iPhone does not turn on or does not work.	<ul style="list-style-type: none"> Check the connection between this unit and iPod/iPhone. Disconnect and reset the iPod/iPhone using hard reset.
"LOADING" appears when you enter search mode by pressing   .	This unit is still preparing the iPod/iPhone music list. It may take some time to load, try again later.	

Troubleshooting

Symptom	Remedy	
CD/iPod/iPod	"NO DISC"	Insert a playable disc into the loading slot.
	"TOC ERROR"	Make sure the disc is clean and inserted properly.
	"NA FILE"	Make sure the media (disc/USB) contain supported audio files. (Page 34)
	"COPY PRO"	A copy-protected file is played (disc/USB).
	"NO DEVICE"	Connect a device (USB/iPod/iPhone), and change the source to USB/iPod USB again.
	"NO MUSIC"	Connect a device (USB/iPod/iPhone) that contains playable audio files.
	"iPod ERROR"	<ul style="list-style-type: none"> Reconnect the iPod. Reset the iPod. Press and hold  SRC to turn off the power. Turn the power on again for error recovery.
	"MEMORY FULL"	You have reached the maximum storage limit of your iPod/iPhone.
SiriusXM® Radio	"CH LOCKED LOCK CODE?"	The selected channel is locked. Enter the correct pass code to unlock. (Page 14)
	"CHAN UNSUB"	The selected channel is unsubscribed. Call 1-866-635-2349 in the U.S.A. or 1-888-539-7474 in Canada to subscribe. (Page 12)
	"CH UNAVAIL"	The selected channel is unavailable. For more information about the SiriusXM channel lineup, visit <www.siriusxm.com>.
	"CHECK ANTENNA"	Check that the antenna and its connection are in good condition.
	"CHECK TUNER"	Make sure the SiriusXM Vehicle Tuner is connected to the unit.

Symptom	Remedy	
SiriusXM® Radio	"NO SIGNAL"	Make sure the antenna is mounted outside the vehicle.
	"SUBSCRIPTION UPDATED — PRESS ENTER TO CONTINUE."	Your subscription is updated. Press the volume knob to continue.
	"CODE ERROR"	Make sure you have entered the correct pass code. (Page 14)
	"NO CONTENT"	There is insufficient content to start TuneScan.
	"SCAN CANCEL"	TuneScan has been aborted.
Bluetooth®	No Bluetooth device is detected.	<ul style="list-style-type: none"> Search from the Bluetooth device again. Reset the unit. (Page 4)
	Bluetooth pairing cannot be made.	<ul style="list-style-type: none"> Make sure you have entered the same PIN code to both the unit and Bluetooth device. Delete pairing information from both the unit and the Bluetooth device, then perform pairing again. (Page 17)
	Echo or noise is heard during a phone conversation.	<ul style="list-style-type: none"> Adjust the microphone unit's position. (Page 16) Check the [ECHO CANCEL] setting. (Page 18)
	Phone sound quality is poor.	<ul style="list-style-type: none"> Reduce the distance between the unit and the Bluetooth device. Move the car to a place where you can get a better signal reception.
	Phone call sound cannot be heard from the car speakers.	<ul style="list-style-type: none"> Press 6  during a call to switch between hands-free and private talk mode. (Page 18)
	Voice calling method is not successful.	<ul style="list-style-type: none"> Use voice calling method in a more quiet environment. Reduce the distance from the microphone when you speak the name. Make sure the same voice as the registered voice tag is used.

Troubleshooting

Symptom	Remedy
Sound is being interrupted or skipped during playback of a Bluetooth audio player.	<ul style="list-style-type: none"> Reduce the distance between the unit and the Bluetooth audio player. Turn off, then turn on the unit and try to connect again. Other Bluetooth devices might be trying to connect to the unit.
The connected Bluetooth audio player cannot be controlled.	<ul style="list-style-type: none"> Check whether the connected Bluetooth audio player supports Audio/Video Remote Control Profile (AVRCP). (Refer to the instructions of your audio player.) Disconnect and connect the Bluetooth player again.
"NOT SUPPORT"	The connected phone does not support Voice Recognition feature or phonebook transfer.
"NO ENTRY"	There is no registered device connected/found via Bluetooth.
"ERROR"	Try the operation again. If "ERROR" appears again, check if the device supports the function you have tried.
"NO INFO"/"NO DATA"	Bluetooth device cannot get the contact information.
"HF ERROR XX"/ "BT ERROR"	Reset the unit and try the operation again. If this does not solve the problem, consult your nearest service center.
"SWITCHING NG"	The connected phones might not support phone switching feature.
The Bluetooth connection between the Bluetooth device and the unit is unstable.	Delete the unused registered Bluetooth device from the unit. (Page 21)

Bluetooth®

Symptom	Remedy
No response from Alexa after the voice input.	Amazon cloud was unable to analyze the voice input.
Wrong response from Alexa.	Alexa misunderstood what was said or did not catch the entire request or sentence spoken. Please try again. (Page 24)
"DISCONNECTED"	Be sure to connect your smartphone to the unit via Bluetooth. (Page 17)
Not able to connect or reconnect to Alexa mobile application.	<ul style="list-style-type: none"> Be sure the audio device is connected via Bluetooth. Select the audio device from [AUDIO SELECT] in [BT MODE]. (Page 21) Perform the one-time setup process again. See "Setup for the first time" on page 23. Turn off, then turn on the unit and try to connect again. For iOS device, make sure Alexa source or iPod BT source is selected.
Not able to exit from "TALKING" screen after ending the call.	It may take some time for the unit to exit the "TALKING" screen. Press number button 6 to return to the previous source control screen.
Not able to go to "LISTENING" screen after activated Alexa.	<ul style="list-style-type: none"> Disconnect and connect the Bluetooth connection again. (Page 17) Disconnect and connect the Alexa connection again. (Page 23) Turn off the unit for about 10 seconds, then turn on the unit and try again.

AMAZON ALEXA

Specifications

Tuner	FM	Frequency Range	87.9 MHz — 107.9 MHz (200 kHz step)
		Usable Sensitivity (S/N = 30 dB)	7.2 dBf (0.63 μ V/75 Ω)
		Quieting Sensitivity (DIN S/N = 46 dB)	15.2 dBf (1.58 μ V/75 Ω)
		Frequency Response (\pm 3.0 dB)	30 Hz — 15 kHz
		Signal-to-Noise Ratio (MONO)	68.0 dB
		Stereo Separation (1 kHz)	40 dB
Digital FM	Frequency Range	87.9 MHz — 107.9 MHz (200 kHz step)	
	Frequency Response (\pm 3 dB)	20 Hz — 20 kHz	
	Signal-to-Noise Ratio (STEREO)	75 dB	
AM	Frequency Range	530 kHz — 1 700 kHz (10 kHz step)	
	Usable Sensitivity (S/N = 20 dB)	29 dB μ (28.2 μ V)	
Digital AM	Frequency Range	530 kHz — 1 700 kHz (10 kHz step)	
	Frequency Response (\pm 3 dB)	40 Hz — 15 kHz	
		Signal-to-Noise Ratio (STEREO)	70 dB

CD player	Laser Diode	GaAlAs
	Digital Filter (D/A)	8 times over sampling
	Spindle Speed	500 rpm — 200 rpm (CLV)
	Wow & Flutter	Below measurable limit
	Frequency Response (\pm 1 dB)	20 Hz — 20 kHz
	Total Harmonic Distortion (1 kHz)	0.01 %
	Signal-to-Noise Ratio (1 kHz)	97 dB
	Dynamic Range	89 dB
	Channel Separation	89 dB
	MP3 Decode	Compliant with MPEG-1/2 Audio Layer-3
WMA Decode	Compliant with Windows Media Audio	
AAC Decode	AAC-LC “.aac” files	

USB	USB Standard	USB 1.1, USB 2.0 (High speed)
	File System	FAT12/16/32
	Maximum Supply Current	DC 5 V \equiv 1.5 A
	Frequency Response (\pm 1 dB)	20 Hz — 20 kHz
	Signal-to-Noise Ratio (1 kHz)	98 dB
	Dynamic Range	93 dB
	Channel Separation	90 dB
	MP3 Decode	Compliant with MPEG-1/2 Audio Layer-3
	WMA Decode	Compliant with Windows Media Audio
	AAC Decode	AAC-LC “.aac”, “.m4a” files
WAV Decode	Linear-PCM	
FLAC Decode	FLAC file (Up to 96 kHz/24 bit)	

Specifications

Auxiliary	Frequency Response (± 3 dB)	20 Hz — 20 kHz
	Input Maximum Voltage	1 000 mV
	Input Impedance	30 k Ω
Bluetooth	Version	Bluetooth 4.2
	Frequency Range	2.402 GHz — 2.480 GHz
	RF Output Power (E.I.R.P.)	+4 dBm (MAX), Power Class 2
	Maximum Communication Range	Line of sight approx. 10 m (32.8 ft)
	Profile	HFP 1.7.1 (Hands-Free Profile) SPP (Serial Port Profile) PBAP (Phonebook Access Profile) A2DP (Advanced Audio Distribution Profile) AVRCP 1.6.1 (Audio/Video Remote Control Profile)
Audio	Maximum Output Power	50 W \times 4
	Full Bandwidth Power (at less than 1 % THD)	22 W \times 4
	Speaker Impedance	4 Ω — 8 Ω

Audio	Tone Action	Band 1: 62.5 Hz \pm 9 dB Band 2: 100 Hz \pm 9 dB Band 3: 160 Hz \pm 9 dB Band 4: 250 Hz \pm 9 dB Band 5: 400 Hz \pm 9 dB Band 6: 630 Hz \pm 9 dB Band 7: 1 kHz \pm 9 dB Band 8: 1.6 kHz \pm 9 dB Band 9: 2.5 kHz \pm 9 dB Band 10: 4 kHz \pm 9 dB Band 11: 6.3 kHz \pm 9 dB Band 12: 10 kHz \pm 9 dB Band 13: 16 kHz \pm 9 dB
	Preout Level/Load	KDC-X705 : 5 000 mV/10 k Ω KDC-BT782HD : 4 000 mV/10 k Ω
	Preout Impedance	\leq 600 Ω
General	Operating Voltage	12 V DC car battery
	Installation Size (W \times H \times D)	182 mm \times 53 mm \times 155.5 mm (7-3/16" \times 2-1/16" \times 6-1/8")
	Net Weight (includes Trim plate and Mounting sleeve)	1.2 kg (2.7 lbs)

Subject to change without notice.

- Windows Media is a registered trademark or trademark of Microsoft Corporation in the United States and/or other countries. This product is protected by certain intellectual property rights of Microsoft. Use or distribution of such technology outside of this product is prohibited without a license from Microsoft.
- HD Radio Technology manufactured under license from iBiquity Digital Corporation. U.S. and Foreign Patents. For patents see <http://dts.com/patents>. HD Radio™ and the HD, HD Radio, and “ARC” logos are registered trademarks or trademarks of iBiquity Digital Corporation in the United States and/or other countries.
- Use of the Made for Apple badge means that an accessory has been designed to connect specifically to the Apple product(s) identified in the badge and has been certified by the developer to meet Apple performance standards. Apple is not responsible for the operation of this device or its compliance with safety and regulatory standards. Please note that the use of this accessory with an Apple product may affect wireless performance.
- Apple, iPhone, iPod, iPod touch, iTunes, and Lightning are trademarks of Apple Inc., registered in the U.S. and other countries.
- iOS is a trademark or registered trademark of Cisco in the U.S. and other countries and is used under license.
- Android is a trademark of Google LLC.
- SiriusXM and all related marks and logos are trademarks of Sirius XM Radio, Inc. All rights reserved.
- The Bluetooth® word mark and logos are registered trademarks owned by Bluetooth SIG, Inc. and any use of such marks by JVCKENWOOD Corporation is under license. Other trademarks and trade names are those of their respective owners.
- Amazon, Alexa and all related marks are trademarks of Amazon.com, Inc. or its affiliates.
- Alexa is not available in all languages and countries. Alexa features and functionality may vary by location.

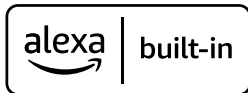

KDC-BT782HD KDC-X705

CD-RECEIVER

Quick Start Guide

AUTORADIO CD

Guide de démarrage rapide

RECEPTOR CD

Guía de inicio rápido

JVCKENWOOD Corporation

For your records

Record the serial number, found on the back of the unit, in the spaces designated on the warranty card, and in the space provided below. Refer to the model and serial numbers whenever you call upon your Kenwood dealer for information or service on the product.

Model KDC-BT782HD/KDC-X705

Serial number _____

US Residents Only

Register Online

Register your Kenwood product at <https://www.kenwood.com/usa/>

For detailed operations and information, refer to the INSTRUCTION MANUAL on the following website:
Pour les opérations et les informations détaillées, reportez-vous au MODE D'EMPLOI sur le site web suivant:
Para obtener más información y detalles sobre las operaciones, consulte el MANUAL DE INSTRUCCIONES en el siguiente sitio web:



<<https://www.kenwood.com/cs/ce/>>

CAUTION

Use of controls or adjustments or performance of procedures other than those specified herein may result in hazardous radiation exposure.
In compliance with Federal Regulations, following are reproductions of labels on, or inside the product relating to laser product safety.

JVCKENWOOD Corporation
2967-3, ISHIKAWA-MACHI,
HACHIOJI-SHI, TOKYO, JAPAN

THIS PRODUCT COMPLIES WITH DHHS RULES 21CFR
SUBCHAPTER J IN EFFECT AT DATE OF MANUFACTURE.

Location : Top Plate

Información acerca de la eliminación de equipos eléctricos y electrónicos al final de la vida útil (aplicable a los países que hayan adoptado sistemas independientes de recogida de residuos)

Los productos con el símbolo de un contenedor con ruedas tachado no podrán ser desechados como residuos domésticos. Los equipos eléctricos y electrónicos al final de la vida útil, deberán ser reciclados en instalaciones que puedan dar el tratamiento adecuado a estos productos y a sus subproductos residuales correspondientes. Póngase en contacto con su administración local para obtener información sobre el punto de recogida más cercano. Un tratamiento correcto del reciclaje y la eliminación de residuos ayuda a conservar los recursos y evita al mismo tiempo efectos perjudiciales en la salud y el medio ambiente.

Informação sobre a eliminação de pilhas

Este produto não deve ser eliminado como lixo doméstico geral. Devolva a pilha usada ao revendedor ou entidade autorizada para que a mesma seja devolvida ao fabricante ou importador. A reciclagem e a eliminação de lixo de maneira apropriada ajudarão a conservar os recursos naturais ao mesmo tempo que prevenirão os efeitos prejudiciais à nossa saúde e ao meio ambiente.

CALIFORNIA, USA ONLY

This product contains a CR Coin Cell Lithium Battery which contains Perchlorate Material—special handling may apply. See www.dtsc.ca.gov/hazardouswaste/perchlorate

FCC CAUTION

Changes or modifications not expressly approved by the party responsible for compliance could void the user's authority to operate the equipment.

NOTE: This equipment has been tested and found to comply with the limits for a Class B digital device, pursuant to part 15 of the FCC Rules. These limits are designed to provide reasonable protection against harmful interference in a residential installation. This equipment generates, uses and can radiate radio frequency energy and, if not installed and used in accordance with the instructions, may cause harmful interference to radio communications. However, there is no guarantee that interference will not occur in a particular installation. If this equipment does cause harmful interference to radio or television reception, which can be determined by turning the equipment off and on, the user is encouraged to try to correct the interference by one or more of the following measures:

- Reorient or relocate the receiving antenna.
- Increase the separation between the equipment and receiver.
- Connect the equipment into an outlet on a circuit different from that to which the receiver is connected.
- Consult the dealer or an experienced radio/TV technician for help.

Supplier's Declaration of Conformity

Trade Name: KENWOOD
Products: CD-RECEIVER
Model Name: KDC-BT782HD/KDC-X705
Responsible Party: JVCKENWOOD USA CORPORATION
4001 Worsham Avenue, Long Beach, CA 90808, U.S.A.
PHONE: 1-800-252-5722

THIS DEVICE COMPLIES WITH PART 15 OF THE FCC RULES. OPERATION IS SUBJECT TO THE FOLLOWING TWO CONDITIONS:

- (1) THIS DEVICE MAY NOT CAUSE HARMFUL INTERFERENCE, AND
- (2) THIS DEVICE MUST ACCEPT ANY INTERFERENCE RECEIVED, INCLUDING INTERFERENCE THAT MAY CAUSE UNDESIRED OPERATION.

ISED Caution

This device contains licence-exempt transmitter(s)/receiver(s) that comply with Innovation, Science and Economic Development Canada's licence-exempt RSS(s). Operation is subject to the following two conditions:

1. This device may not cause interference.
2. This device must accept any interference, including interference that may cause undesired operation of the device.

Attention de l'ISED

L'émetteur/récepteur exempt de licence contenu dans le présent appareil est conforme aux CNR d'Innovation, Sciences et Développement économique Canada applicables aux appareils radio exempts de licence. L'exploitation est autorisée aux deux conditions suivantes :

1. L'appareil ne doit pas produire de brouillage.
2. L'appareil doit accepter tout brouillage radioélectrique subi, même si le brouillage est susceptible d'en compromettre le fonctionnement.

Contains Bluetooth Module FCC ID: ZWY88112
IC ID: 12033A-88112

This transmitter must not be co-located or operated in conjunction with any other antenna or transmitter.

CAUTION

This equipment complies with FCC/ISED radiation exposure limits set forth for an uncontrolled environment and meets the FCC radio frequency (RF) Exposure Guidelines and RSS-102 of the ISED radio frequency (RF) Exposure rules. This equipment should be installed and operated keeping the radiator at least 20 cm or more away from person's body.

ATTENTION

Cet équipement est conforme aux limites d'exposition aux rayonnements énoncées pour un environnement non contrôlé et respecte les règles des radioélectriques (RF) de la FCC lignes directrices d'exposition et d'exposition aux fréquences radioélectriques (RF) CNR-102 de l'ISED. Cet équipement doit être installé et utilisé en gardant une distance de 20 cm ou plus entre le radiateur et le corps humain.

Para cumplimiento de la IFT:

“La operación de este equipo está sujeta a las siguientes dos condiciones:

- (1) es posible que este equipo o dispositivo no cause interferencia perjudicial y
- (2) este equipo o dispositivo debe aceptar cualquier interferencia, incluyendo la que pueda causar su operación no deseada”

SOFTWARE LICENSE AGREEMENT

The software embedded in the Product (hereinafter the "Licensed Software") provided by Licensor is copyrighted to or sublicensable by the Licensor, and this Agreement provides for the terms and conditions which Users shall follow in order to use the Licensed Software.

The User shall use the Licensed Software by agreeing with the terms of this Software License Agreement. This Agreement shall be deemed completed at the time the User (hereinafter the "User") initially used the Product in which the "Licensed Software" is embedded.

The Licensed Software may include the software which has been licensed to the Licensor directly or indirectly from any third party. In such case, some third parties require the Users to follow their conditions for use separately from this Software License Agreement. Such software shall not be subject to this Agreement, and the Users are urged to read the "Important Notice concerning the Software" to be provided separately below.

Article 1 General Provision

The Licensor shall grant to the User a non-exclusive and non-transferable (other than the exceptional case referred to in Article 3, Paragraph 1) licensed to use the Licensed Software within the country of the User. (the country where the User bought the Product (hereinafter the "Country"))

Article 2 License

1. The license granted under this Agreement shall be the right to use the Licensed Software in the Product.
2. The User shall not duplicate, copy, modify, add, translate or otherwise alter, or lease the Licensed Software and any related documents, whether in whole or in part.
3. The use of the Licensed Software shall be limited to personal purpose, and the Licensed Software shall not be distributed, licensed or sub-licensed whether it is for commercial purpose or not.
4. The User shall use the Licensed Software according to the directions described in the operation manual or help file, and is prohibited to use or duplicate any data in a manner violating the Copyright Law or any other laws and regulations by applying whole or a part of the Licensed Software.

Article 3 Conditions for Grant of License

1. When the User transfers the Product, it may also transfer the license to use the Licensed Software embedded in the Product (including any related materials, updates and upgrades) on condition that no original, copies or related materials continue in the possession of the User, and that the User shall cause the transferee to comply with this Software License Agreement.
2. The User shall not carry out reverse engineering, disassembling, decompiling or any other code analysis works in connection with the Licensed Software.

Article 4 Right pertaining to the Licensed Software

Any and all copyrights and other rights pertaining to the Licensed Software and related documents shall belong to the Licensor or the original holder of the right who granted to the Licensor the license or sublicense for the Licensed Software (hereinafter the "Original Rightholder"), and the User shall not be entitled to any right other than the license granted hereunder, in respect of the Licensed Software and any related documents.

Article 5 Indemnification of Licensor

1. Neither the Licensor nor the Original Rightholder shall be liable for any damage incurred by the User or any third party due to the exercise of the license granted to the User under this Agreement, unless otherwise restricted by law.
2. The Licensor will offer no guarantee for the merchantability, convertibility and consistency with certain objective of the Licensed Software.

Article 6 Liability to Third Party

If any dispute has arisen with any third party due to an infringement upon a copyright, patent or any other intellectual property right that was caused by the User's use of the Licensed Software, the User shall settle such dispute at its own cost and hold the Licensor and the Original Rightholder harmless from any inconvenience it may cause.

Article 7 Confidentiality

The User shall keep the confidentiality of such portion of the Licensed Software, related documents thereof or any other information to be granted under this Agreement, as well as the conditions of this Agreement as has not yet entered the public domain, and shall not disclose or divulge the same to any third party without approval of the Licensor.

Article 8 Termination

In case the User falls under any of the events described in the following items, the Licensor may immediately terminate this Agreement or claim that the User compensates for the damage incurred by the Licensor due to such event:

- (1) when the User violated any provision of this Agreement; or
- (2) when a petition has been filed against the User for an attachment, provisional attachment, provisional disposition or any other compulsory execution.

Article 9 Destruction of the Licensed Software

If this Agreement is terminated pursuant to the provision of Article 8, the User shall destroy the Licensed Software, any related documents and copies thereof within two (2) weeks from such date of termination.

Article 10 Protection of Copyright

1. The copyright and all the other intellectual property rights relating to the Licensed Software shall belong to the Licensor and the Original Rightholder, and in no event shall they be under the ownership of the User.
2. The User shall, whenever it uses the Licensed Software, comply with any laws relating to the copyright and other intellectual property rights.

Article 11 Export Restriction

1. It is prohibited to export the Licensed Software and any related documents outside the country of the User (including transmission thereof outside the country of the User via Internet of other communication tools).
2. The User shall understand that the Licensed Software shall be subject to the export restrictions adopted by the country of User and any other countries.
3. The User shall agree that the software will be subject to any and all applicable international and domestic laws (including the export control regulation of the country of User and any other countries, and any restrictions concerning the end-users, the use by end-users and importing countries to be provided by the country of User and any other countries, and any other governmental authorities).

Article 12 Miscellaneous

1. In the event any part of this Agreement is invalidated by operation of law, the residual provisions shall continue in force.
2. Matters not stipulated in this Agreement or any ambiguity or question raised in the construction of this Agreement shall be provided or settled upon good-faith consultation between the Licensor and the User.
3. The Licensor and the User hereby agree that this Agreement is governed by the laws of Japan, and any dispute arising from, and relating to the rights and obligations under, this Agreement shall be submitted to the exclusive jurisdiction of the Tokyo District Court for its first instance.

Important Notice concerning the Software

-jansson

Copyright (c) 2009-2012 Petri Lehtinen <petri@digip.org>

Permission is hereby granted, free of charge, to any person obtaining a copy of this software and associated documentation files (the "Software"), to deal in the Software without restriction, including without limitation the rights to use, copy, modify, merge, publish, distribute, sublicense, and/or sell copies of the Software, and to permit persons to whom the Software is furnished to do so, subject to the following conditions:

The above copyright notice and this permission notice shall be included in all copies or substantial portions of the Software.

THE SOFTWARE IS PROVIDED "AS IS", WITHOUT WARRANTY OF ANY KIND, EXPRESS OR IMPLIED, INCLUDING BUT NOT LIMITED TO THE WARRANTIES OF MERCHANTABILITY, FITNESS FOR A PARTICULAR PURPOSE AND NONINFRINGEMENT. IN NO EVENT SHALL THE AUTHORS OR COPYRIGHT HOLDERS BE LIABLE FOR ANY CLAIM, DAMAGES OR OTHER LIABILITY, WHETHER IN AN ACTION OF CONTRACT, TORT OR OTHERWISE, ARISING FROM, OUT OF OR IN CONNECTION WITH THE SOFTWARE OR THE USE OR OTHER DEALINGS IN THE SOFTWARE.

-cJSON

Copyright (c) 2009 Dave Gamble

Permission is hereby granted, free of charge, to any person obtaining a copy of this software and associated documentation files (the "Software"), to deal in the Software without restriction, including without limitation the rights to use, copy, modify, merge, publish, distribute, sublicense, and/or sell copies of the Software, and to permit persons to whom the Software is furnished to do so, subject to the following conditions:

The above copyright notice and this permission notice shall be included in all copies or substantial portions of the Software.

THE SOFTWARE IS PROVIDED "AS IS", WITHOUT WARRANTY OF ANY KIND, EXPRESS OR IMPLIED, INCLUDING BUT NOT LIMITED TO THE WARRANTIES OF MERCHANTABILITY, FITNESS FOR A PARTICULAR PURPOSE AND NONINFRINGEMENT. IN NO EVENT SHALL THE AUTHORS OR COPYRIGHT HOLDERS BE LIABLE FOR ANY CLAIM, DAMAGES OR OTHER LIABILITY, WHETHER IN AN ACTION OF CONTRACT, TORT OR OTHERWISE, ARISING FROM, OUT OF OR IN CONNECTION WITH THE SOFTWARE OR THE USE OR OTHER DEALINGS IN THE SOFTWARE.

-CMP

The MIT License (MIT)

Copyright (c) 2014 Charles Gunyon

Permission is hereby granted, free of charge, to any person obtaining a copy of this software and associated documentation files (the "Software"), to deal in the Software without restriction, including without limitation the rights to use, copy, modify, merge, publish, distribute, sublicense, and/or sell copies of the Software, and to permit persons to whom the Software is furnished to do so, subject to the following conditions:

The above copyright notice and this permission notice shall be included in all copies or substantial portions of the Software.

THE SOFTWARE IS PROVIDED "AS IS", WITHOUT WARRANTY OF ANY KIND, EXPRESS OR IMPLIED, INCLUDING BUT NOT LIMITED TO THE WARRANTIES OF MERCHANTABILITY, FITNESS FOR A PARTICULAR PURPOSE AND NONINFRINGEMENT. IN NO EVENT SHALL THE AUTHORS OR COPYRIGHT HOLDERS BE LIABLE FOR ANY CLAIM, DAMAGES OR OTHER LIABILITY, WHETHER IN AN ACTION OF CONTRACT, TORT OR OTHERWISE, ARISING FROM, OUT OF OR IN CONNECTION WITH THE SOFTWARE OR THE USE OR OTHER DEALINGS IN THE SOFTWARE.

nanopb

Copyright (c) 2011 Petteri Aimonen <jpa at nanopb.mail.kapsi.fi>

This software is provided 'as-is', without any express or implied warranty. In no event will the authors be held liable for any damages arising from the use of this software.

Permission is granted to anyone to use this software for any purpose, including commercial applications, and to alter it and redistribute it freely, subject to the following restrictions:

1. The origin of this software must not be misrepresented; you must not claim that you wrote the original software. If you use this software in a product, an acknowledgment in the product documentation would be appreciated but is not required.
2. Altered source versions must be plainly marked as such, and must not be misrepresented as being the original software.
3. This notice may not be removed or altered from any source distribution.

sha2

AUTHOR: Aaron D. Gifford - <http://www.aarongifford.com/>

Copyright (c) 2000-2001, Aaron D. Gifford

All rights reserved.

You may obtain a copy of the license at

<https://opensource.org/licenses/BSD-3-Clause>

THE SOFTWARE IS PROVIDED "AS IS", WITHOUT WARRANTY OF ANY KIND, EXPRESS OR IMPLIED, INCLUDING BUT NOT LIMITED TO THE WARRANTIES OF MERCHANTABILITY, FITNESS FOR A PARTICULAR PURPOSE AND NONINFRINGEMENT. IN NO EVENT SHALL THE AUTHORS OR COPYRIGHT HOLDERS BE LIABLE FOR ANY CLAIM, DAMAGES OR OTHER LIABILITY, WHETHER IN AN ACTION OF CONTRACT, TORT OR OTHERWISE, ARISING FROM, OUT OF OR IN CONNECTION WITH THE SOFTWARE OR THE USE OR OTHER DEALINGS IN THE SOFTWARE.

Posix

Copyright (c) 1990, 1993

The Regents of the University of California. All rights reserved.

Redistribution and use in source and binary forms, with or without modification, are permitted provided that the following conditions are met:

1. Redistributions of source code must retain the above copyright notice, this list of conditions and the following disclaimer.
2. Redistributions in binary form must reproduce the above copyright notice, this list of conditions and the following disclaimer in the documentation and/or other materials provided with the distribution.
3. All advertising materials mentioning features or use of this software must display the following acknowledgement:
This product includes software developed by the University of California, Berkeley and its contributors.
4. Neither the name of the University nor the names of its contributors may be used to endorse or promote products derived from this software without specific prior written permission.

Copyright (C) 1993 by Sun Microsystems, Inc. All rights reserved.

Developed at SunPro, a Sun Microsystems, Inc. business.

Permission to use, copy, modify, and distribute this software is freely granted, provided that this notice is preserved.

Copyright (C) 1991-2, RSA Data Security, Inc. Created 1991. All rights reserved.

License to copy and use this software is granted provided that it is identified as the "RSA Data Security, Inc. MD4 Message-Digest Algorithm" in all material mentioning or referencing this software or this function.

Copyright (c) 1995, 1996 Carnegie-Mellon University. All rights reserved.

Author: Chris G. Demetriou

Permission to use, copy, modify and distribute this software and its documentation is hereby granted, provided that both the copyright notice and this permission notice appear in all copies of the software, derivative works or modified versions, and any portions thereof, and that both notices appear in supporting documentation.

CARNEGIE MELLON ALLOWS FREE USE OF THIS SOFTWARE IN ITS "AS IS" CONDITION. CARNEGIE MELLON DISCLAIMS ANY LIABILITY OF ANY KIND FOR ANY DAMAGES WHATSOEVER RESULTING FROM THE USE OF THIS SOFTWARE.

Carnegie Mellon requests users of this software to return to

Software Distribution Coordinator or Software.Distribution@CS.CMU.EDU

School of Computer Science

Carnegie Mellon University

Pittsburgh PA 15213-3890

any improvements or extensions that they make and grant Carnegie the rights to redistribute these changes.

License is also granted to make and use derivative works provided that such works are identified as "derived from the RSA Data Security, Inc. MD4 Message-Digest Algorithm" in all material mentioning or referencing the derived work.

RSA Data Security, Inc. makes no representations concerning either the merchantability of this software or the suitability of this software for any particular purpose. It is provided "as is" without express or implied warranty of any kind.

Copyright (c) 1993 Martin Birgmeier

All rights reserved.

You may redistribute unmodified or modified versions of this source code provided that the above copyright notice and this and the following conditions are retained.

This software is provided "as is", and comes with no warranties of any kind. I shall in no event be liable for anything that happens to anyone/anything when using this software.

These notices must be retained in any copies of any part of this documentation and/or software.

T-Kernel 2.0

This product uses the source code of T-Kernel 2.0 under T-License 2.0 granted by T-Engine Forum (www.tron.org)

BSD-3-Clause

Copyright (c) 2000-2001, Aaron D. Gifford

All rights reserved.

You may obtain a copy of the license at

<https://opensource.org/licenses/BSD-3-Clause>

THE SOFTWARE IS PROVIDED "AS IS", WITHOUT WARRANTY OF ANY KIND, EXPRESS OR IMPLIED, INCLUDING BUT NOT LIMITED TO THE WARRANTIES OF MERCHANTABILITY, FITNESS FOR A PARTICULAR PURPOSE AND NONINFRINGEMENT. IN NO EVENT SHALL THE AUTHORS OR COPYRIGHT HOLDERS BE LIABLE FOR ANY CLAIM, DAMAGES OR OTHER LIABILITY, WHETHER IN AN ACTION OF CONTRACT, TORT OR OTHERWISE, ARISING FROM, OUT OF OR IN CONNECTION WITH THE SOFTWARE OR THE USE OR OTHER DEALINGS IN THE SOFTWARE.

LFS Subsystem

Copyright The Regents of the University of California. All rights reserved.

You may obtain a copy of the license at

<https://directory.fsf.org/wiki/License:BSD-4-Clause>

THE SOFTWARE IS PROVIDED "AS IS", WITHOUT WARRANTY OF ANY KIND, EXPRESS OR IMPLIED, INCLUDING BUT NOT LIMITED TO THE WARRANTIES OF MERCHANTABILITY, FITNESS FOR A PARTICULAR PURPOSE AND NONINFRINGEMENT. IN NO EVENT SHALL THE AUTHORS OR COPYRIGHT HOLDERS BE LIABLE FOR ANY CLAIM, DAMAGES OR OTHER LIABILITY, WHETHER IN AN ACTION OF CONTRACT, TORT OR OTHERWISE, ARISING FROM, OUT OF OR IN CONNECTION WITH THE SOFTWARE OR THE USE OR OTHER DEALINGS IN THE SOFTWARE.

Accordo2 Player

Apache License

Licensed under the Apache License,

Version 2.0, January 2004(the "License");

You may obtain a copy of the license at

<http://www.apache.org/licenses/LICENSE-2.0>

THE SOFTWARE IS PROVIDED "AS IS", WITHOUT WARRANTY OF ANY KIND, EXPRESS OR IMPLIED, INCLUDING BUT NOT LIMITED TO THE WARRANTIES OF MERCHANTABILITY, FITNESS FOR A PARTICULAR PURPOSE AND NONINFRINGEMENT. IN NO EVENT SHALL THE AUTHORS OR COPYRIGHT HOLDERS BE LIABLE FOR ANY CLAIM, DAMAGES OR OTHER LIABILITY, WHETHER IN AN ACTION OF CONTRACT, TORT OR OTHERWISE, ARISING FROM, OUT OF OR IN CONNECTION WITH THE SOFTWARE OR THE USE OR OTHER DEALINGS IN THE SOFTWARE.

Installation/Connection

This section is for the professional installer.

For safety's sake, leave wiring and mounting to professionals. Consult the car audio dealer.

▲ WARNING

- The unit can only be used with a 12 V DC power supply, negative ground.
- Disconnect the battery's negative terminal before wiring and mounting.
- Do not connect Battery wire (yellow) and Ignition wire (red) to the car chassis or Ground wire (black) to prevent a short circuit.
- To prevent short circuit:
 - Insulate unconnected wires with vinyl tape.
 - Be sure to ground this unit to the car's chassis again after installation.
 - Secure the wires with cable clamps and wrap vinyl tape around the wires that comes into contact with metal parts to protect the wires.

▲ CAUTION

- Install this unit in the console of your vehicle. Do not touch the metal parts of this unit during and shortly after use of the unit. Metal parts such as the heat sink and enclosure become hot.
- Do not connect the ⊖ wires of speakers to the car chassis or Ground wire (black), or connect them in parallel.
- Mount the unit at an angle of less than 30°.
- If your vehicle wiring harness does not have the ignition terminal, connect Ignition wire (red) to the terminal on the vehicle's fuse box which provides 12 V DC power supply and is turned on and off by the ignition key.
- Keep all cables away from heat dissipate metal parts.
- After the unit is installed, check whether the brake lamps, blinkers, wipers, etc. on the car are working properly.
- If the fuse blows, first make sure the wires are not touching car's chassis, then replace the old fuse with one that has the same rating.

■ Basic procedure

- 1 Remove the key from the ignition switch, then disconnect the ⊖ terminal of the car battery.
- 2 Connect the wires properly. See "Wiring connection" on page 3.
- 3 Install the unit to your car. See the following "Installing the unit (in-dash mounting)".
- 4 Connect the ⊖ terminal of the car battery.
- 5 Press \odot SRC to turn on the power.
- 6 Detach the faceplate and reset the unit within 5 seconds. See "How to reset" on page 4.

Installing the unit (in-dash mounting)

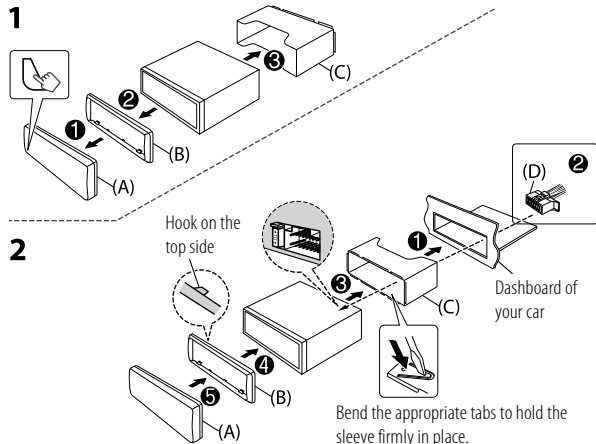

Part list (supplied)

- | | |
|--------------------------|------------------|
| (A) Faceplate (×1) | (F) Screws |
| (B) Trim plate (×1) | ① M5 × 7 mm (×4) |
| (C) Mounting sleeve (×1) | ② M5 × 6 mm (×4) |
| (D) Wiring harness (×1) | ③ M4 × 8 mm (×1) |
| (E) Extraction key (×2) | |

Installing the unit (without mounting sleeve)

- 1 Remove the mounting sleeve and trim plate from the unit.
- 2 Align the holes in the unit (on both sides) with the vehicle mounting bracket and secure the unit with supplied screws.

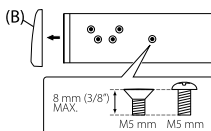

▲ Use only the specified screws. Using wrong screws might damage the unit.

Removing the unit

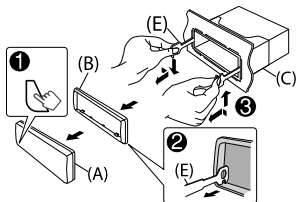

Wiring connection

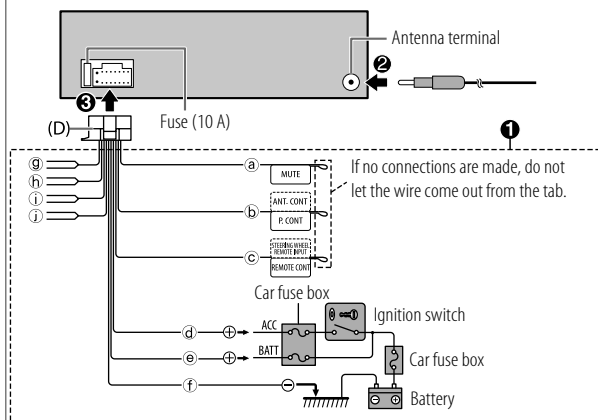

- | | |
|--|---|
| a) Brown: Connect to the device equipped with muting feature to mute this unit | g) White ⊕, White/black ⊖: Front speaker (left) |
| b) Blue/white: To the power control terminal when using the optional power amplifier or to the antenna control terminal in the vehicle | h) Gray ⊕, Gray/black ⊖: Front speaker (right) |
| c) Light blue/yellow: To the steering wheel remote control adapter | i) Green ⊕, Green/black ⊖: Rear speaker (left) |
| d) Red: Ignition 12 V | j) Purple ⊕, Purple/black ⊖: Rear speaker (right) |
| e) Yellow: Battery 12 V | |
| f) Black: Ground | |

Before Use

IMPORTANT

- To ensure proper use, please read through this Guide before using this product. It is especially important that you read and observe Warnings and Cautions in this Guide.
- Please keep the Guide in a safe and accessible place for future reference.

▲ WARNING

Do not operate any function that takes your attention away from safe driving.

▲ CAUTION

Volume setting:

- Adjust the volume so that you can hear sounds outside the car to prevent accidents.
- Lower the volume before playing digital sources to avoid damaging the speakers by the sudden increase of the output level.

General:

- Avoid using the external device if it might hinder safe driving.
- Make sure all important data has been backed up. We shall bear no responsibility for any loss of recorded data.
- Never put or leave any metallic objects (such as coins or metal tools) inside the unit to prevent a short circuit.
- If a disc error occurs due to condensation on the laser lens, eject the disc and wait for the moisture to evaporate.
- USB rating is indicated on the main unit. To view, detach the faceplate.
- Depending on the types of cars, the antenna will automatically extend when you turn on the unit with the antenna control wire connected. Turn off the unit or change the source to STANDBY when parking at a low ceiling area.

Basics

Faceplate

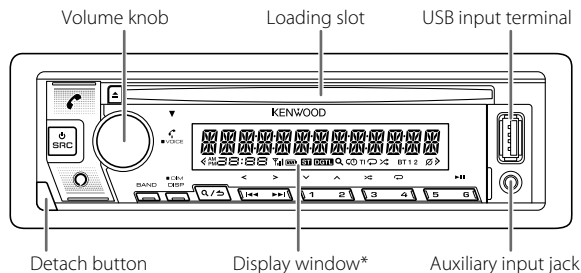

* Only for illustration purpose.

To	On the faceplate
Attach	Reset the unit within 5 seconds after detaching the faceplate.
Detach	Turn on the power Press SRC . • Press and hold to turn off the power.
How to reset	Turn the volume knob.
	Press SRC repeatedly.
	Press DISP repeatedly.

Getting Started

1 Select the display language and cancel the demonstration

When you turn on the power for the first time (or [FACTORY RESET] is set to [YES]), the display shows: "SEL LANGUAGE" → "PRESS" → "VOLUME KNOB"

- 1 Turn the volume knob to select [ENG] (English) / [SPA] (Spanish) / [FRE] (French), then press the knob.
[ENG] is selected for the initial setup.
Then, the display shows: "CANCEL DEMO" → "PRESS" → "VOLUME KNOB".
- 2 Press the volume knob again.
[YES] is selected for the initial setup.
- 3 Press the volume knob again.
"DEMO OFF" appears.

2 Set the clock and date

- 1 Press the volume knob to enter [FUNCTION].
- 2 Turn the volume knob to select [CLOCK], then press the knob.

To adjust the clock

- 3 Turn the volume knob to select [CLOCK ADJUST], then press the knob.
- 4 Turn the volume knob to make the settings, then press the knob.
Set the time in the order of "Hour" → "Minute".
- 5 Turn the volume knob to select [CLOCK FORMAT], then press the knob.
- 6 Turn the volume knob to select [12H] or [24H], then press the knob.

To set the date

- 7 Turn the volume knob to select [DATE FORMAT], then press the knob.
- 8 Turn the volume knob to select [DD/MM/YY] or [MM/DD/YY], then press the knob.
- 9 Turn the volume knob to select [DATE SET], then press the knob.

- 10 Turn the volume knob to make the settings, then press the knob.
Set the date in the order of "Day" → "Month" → "Year" or "Month" → "Day" → "Year".

- 11 Press and hold **Q** / **↵** to exit.

To return to the previous setting item, press **Q** / **↵**.

3 Set the other optional settings

You can only set the following items while the unit is in STANDBY source.

- 1 Press **⏻** SRC repeatedly to enter STANDBY.
- 2 Press the volume knob to enter [FUNCTION].
- 3 Turn the volume knob to select an item (see the following table), then press the knob.
- 4 Repeat step 3 until the desired item is selected or activated.
- 5 Press and hold **Q** / **↵** to exit.

To return to the previous setting item, press **Q** / **↵**.

Default: [XX]

[SYSTEM]	
[KEY BEEP]	[ON]: Activates the keypress tone. ; [OFF]: Deactivates.
[FACTORY RESET]	[YES]: Resets the settings to default (except the stored station). ; [NO]: Cancels.
[ENGLISH]	Select the display language for [FUNCTION] menu and music information if applicable. By default, [ENGLISH] is selected.
[ESPANOL]	
[FRANCAIS]	

HD Radio™ Tuner

You can tune in to both conventional and HD Radio broadcasts.

■ Search for a station or channel

- 1 Press SRC repeatedly to select HD RADIO.
- 2 Press BAND repeatedly to select FM1/FM2/FM3/AM.
- 3 Press / to search for a station or channel.

■ Settings in memory

You can store up to 18 stations/channels for FM and 6 stations/channels for AM.

Store a station or channel

While listening to a station/channel....

Press and hold one of the number buttons (1 to 6).

Select a stored station or channel

Press one of the number buttons (1 to 6).

CD/USB/iPod

Selectable sources:

CD/USB/iPod USB or iPod BT

■ Start playback

The source changes automatically and playback starts when you load a disc or attach a device (USB device/ iPod/iPhone) to the USB input terminal.

- Be sure [USB] is selected for [IPHONE SETUP] in [USB] menu for listening to iPod/iPhone.

To	On the faceplate
Play back/pause	Press 6
Reverse/Fast-forward	Press and hold /
Select a track/file	Press /
Select a folder	Press 2 / 1
Repeat play	Press 4 repeatedly.
Random play	Press 3 repeatedly.

Functions Settings

- 1 Press the volume knob to enter [FUNCTION].
- 2 Turn the volume knob to select an item, then press the knob.
- 3 Repeat step 2 until the desired item is selected or activated.
- 4 Press and hold **Q/↵** to exit.

To return to the previous setting item, press **Q/↵**.

- Refer to the INSTRUCTION MANUAL on the following website for the detailed explanation of each item: <<https://www.kenwood.com/cs/ce/>>
- The availability of each item vary depending on the model.

[FUNCTION] menu items

- [AUDIO CONTROL] : Sets your preferred audio settings.
[DISPLAY] : Sets your preferred control for the display window.
[TUNER SETTING] : Settings for radio source.
[SIRIUS XM] : Settings for Sirius XM tuner.
[USB] : Settings for using a USB device.
[BT MODE] : Settings for using a Bluetooth device.
[REMOTE APP] : Settings for using smartphone to control this unit.
[ALEXA SETUP] : Sets your preferred voice control language for Alexa.
[MIC GAIN]* : Sets the sensitivity of the microphone.
[NR LEVEL]* : Adjusts the noise reduction level.
[ECHO CANCEL]* : Adjusts the echo cancellation delay time.
[SYSTEM] : Settings for this unit.
[CLOCK] : Adjusts the clock.
[ENGLISH] : Selects language for the menu and music information.
[ESPAÑOL] : Selects language for the menu and music information.
[FRANCAIS] : Selects language for the menu and music information.
[DEMO MODE] : Activates or deactivates the display demonstration.

* Applicable only while talking on the phone.

Examples of some well-used settings

■ Subwoofer Level Setting

- 1 Press the volume knob to enter [FUNCTION].



- 2 Turn the volume knob to select [AUDIO CONTROL], then press the knob.



- 3 Turn the volume knob to select [SUBWOOFER SET], then press the knob.



- 4 Turn the volume knob to select [SW SET ON], then press the knob.

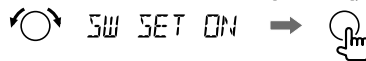

- 5 Turn the volume knob to select [SUB-W LEVEL], then press the knob.

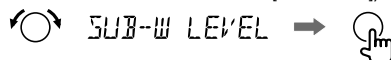

- 6 Turn the volume knob to adjust the subwoofer level, then press the knob.

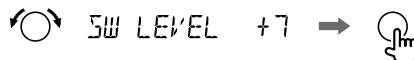

- 7 Press and hold **Q/↵** to exit.



■ Illumination Color Setting

You can set your preferred illumination color for each zone.

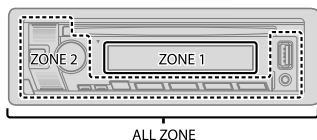

- 1 Press the volume knob to enter [FUNCTION].



- 2 Turn the volume knob to select [DISPLAY], then press the knob.

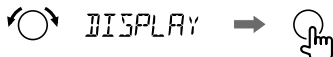

- 3 Turn the volume knob to select [COLOR SELECT], then press the knob.

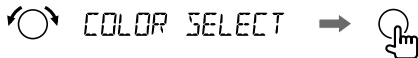

- 4 Turn the volume knob to select a zone ([ALL ZONE], [ZONE 1], [ZONE 2]), then press the knob.



- 5 Turn the volume knob to select a color for the selected zone, then press the knob.



- 6 Repeat step 4 and step 5 to set color for other zones.
- 7 Press and hold Q/↵ to exit.



Other Information

For playback operations of **AUX, SiriusXM® Radio** and **AMAZON ALEXA** sources, refer to the INSTRUCTION MANUAL on the following website:

<<https://www.kenwood.com/cs/ce/>>

- The availability of each source vary depending on the model.

Note for specifications

Bluetooth Frequency Range:

2.402 GHz — 2.480 GHz

Bluetooth RF Output Power (E.I.R.P.):

+4 dBm (MAX), Power Class 2

Speaker Impedance:

4 Ω — 8 Ω

Operating Voltage:

12 V DC car battery

Bluetooth®

- Depending on the Bluetooth version, operating system and the firmware version of your mobile phone, Bluetooth features may not work with this unit.
- Be sure to turn on the Bluetooth function of the device to make the following operations.
- Signal conditions vary depending on the surroundings.

■ Connect the microphone

Connect the supplied microphone to the microphone input jack on the rear panel.

Adjust the microphone angle

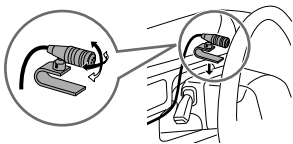

Secure using cord clamps (not supplied) if necessary.

■ Pair and connect a Bluetooth device for the first time

- 1 Press **⏻** SRC to turn on the unit.
- 2 Search and select the name of your receiver ("KDC-BT782HD"/"KDC-X705") on the Bluetooth device.
"PAIRING" → "PASS XXXXXX" → "Device name" → "PRESS" → "VOLUME KNOB" appears on the display.
 - For some Bluetooth devices, you may need to enter the Personal Identification Number (PIN) code immediately after searching.
- 3 Press the volume knob to start pairing.
"PAIRING OK" appears when pairing is completed.

Once pairing is completed, Bluetooth connection is established automatically.

- "BT 1" and/or "BT 2" indicator on the display window lights up.
"🔋" indicator lights up to show the strength of the battery and signal of the connected device.

■ Answer a call

Press **📞** or the volume knob or one of the number buttons (1 to 6).

- To adjust the phone volume [00] to [35], turn the volume knob.
- To end a call, press **📞/📞**.

■ Audio player via Bluetooth

- 1 Press **⏻** SRC repeatedly to select BT AUDIO.
- 2 Operate the audio player via Bluetooth to start playback.

To	On the faceplate
Play back/pause	Press 6 ▶ .
Select group or folder	Press 2 ^ / 1 v .
Reverse skip/Forward skip	Press ◀◀ / ▶▶ .
Reverse/Fast-forward	Press and hold ◀◀ / ▶▶ .
Repeat play	Press 4 ↺ repeatedly.
Random play	Press and hold 3 ⌘ to select [ALL RANDOM] or [GROUP RANDOM].

- Windows Media is a registered trademark or trademark of Microsoft Corporation in the United States and/or other countries. This product is protected by certain intellectual property rights of Microsoft. Use or distribution of such technology outside of this product is prohibited without a license from Microsoft.
- HD Radio Technology manufactured under license from iBiquity Digital Corporation. U.S. and Foreign Patents. For patents see <http://dts.com/patents>. HD Radio™ and the HD, HD Radio, and “ARC” logos are registered trademarks or trademarks of iBiquity Digital Corporation in the United States and/or other countries.
- Use of the Made for Apple badge means that an accessory has been designed to connect specifically to the Apple product(s) identified in the badge and has been certified by the developer to meet Apple performance standards. Apple is not responsible for the operation of this device or its compliance with safety and regulatory standards. Please note that the use of this accessory with an Apple product may affect wireless performance.
- Apple, iPhone, iPod, iPod touch, iTunes, and Lightning are trademarks of Apple Inc., registered in the U.S. and other countries.
- iOS is a trademark or registered trademark of Cisco in the U.S. and other countries and is used under license.
- Android is a trademark of Google LLC.
- SiriusXM and all related marks and logos are trademarks of Sirius XM Radio, Inc. All rights reserved.
- The Bluetooth® word mark and logos are registered trademarks owned by Bluetooth SIG, Inc. and any use of such marks by JVCKENWOOD Corporation is under license. Other trademarks and trade names are those of their respective owners.
- Amazon, Alexa and all related marks are trademarks of Amazon.com, Inc. or its affiliates.
- Alexa is not available in all languages and countries. Alexa features and functionality may vary by location.

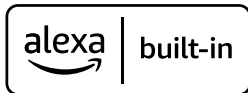

MILITARY

Units purchased through the U.S.A. military exchange service overseas may be serviced under warranty in the continental U.S.A., subject to the following conditions.

- 1) The original warranty is in effect.
- 2) Proof of purchase is provided to the servicer.

WARRANTY FOR MILITARY MARKET

JVC KENWOOD corporation is proud of the quality and workmanship of its audio equipment. This unit has been properly designed, tested and inspected before it was shipped to you. If properly installed and operated in accordance with instructions furnished, it should give you an optimum reliable performance.

WARRANTY PERIOD

This product is warranted for a period of (1) year from the date of the original purchase.

SCOPE OF WARRANTY

Except as specified below, this warranty covers all defects in materials and workmanship of the Kenwood brand products.

During the warranty period, any authorized Kenwood Service Center in the military market listed in the back of this warranty card will provide you free-of-charge both parts and labor required to correct any defect in materials or workmanship.

The following are not covered by this warranty.

1. Voltage conversions.
2. Periodic check-ups which do not disclose any defect covered by the warranty.
3. Cabinets, grilles, other exterior finishes, belts, tape heads, and other non-durable parts and accessories.
4. Units on which the serial number has been effaced, modified or removed.
5. Installation and/or removal charges.
6. Damaged magnetic tapes.
7. House call charges for any repairs.
8. Shipping or delivery charges to or from an authorized Kenwood Service Center.
9. This warranty will not cover any failure that is due to any of the following conditions in accordance with the visual inspection of the authorized Kenwood Service Center:
 - * Improper maintenance or repair, including the installation of parts or accessories that do not conform to the quality and specifications of the original parts.
 - * Misuse, abuse, neglect, unauthorized product modification or failure to follow instructions contained in the Owner's Manual.
 - * Accidental or intentional damages.
 - * Repairs or attempted repairs by an unauthorized agency. (All repairs must be performed at an authorized Kenwood Service Center.)
 - * Damages or deteriorations caused during shipment. (Claims must be presented to the carrier).
 - * Damages or deteriorations resulting from removal and/or replacement.

PURCHASER'S RESPONSIBILITIES

As the purchaser of a new Kenwood brand product, you are requested to do the following in order to obtain Kenwood warranty service.

1. Retain your sales slip or other evidence of purchase for proving your eligibility for requesting Kenwood warranty service.
2. Make your unit available to an authorized Kenwood Service Center in the military market for inspection and approved warranty service, or ship your unit in its original carton box or equivalent, fully insured and shipping charges prepaid, to the authorized Kenwood Service Center.

LIMITATION OF IMPLIED WARRANTIES

Any and all implied warranties, including warranties of merchantability and fitness for a particular purpose, shall be limited in duration to the length of this warranty.

EXCLUSION OF CERTAIN DAMAGES

KENWOOD's liability for any defective product is limited to the repair or replacement of said product, at our option, and shall not include damages of any kind, whether incidental, consequential or otherwise, except to the extent prohibited by applicable law.

KENWOOD AUTHORIZED SERVICE CENTERS IN MILITARY MARKET

JAPAN:

Yokota
Kenwood Rep.; c/o
Yokota BX, JAAX AAFES-PAC,
APO San Francisco 96328

Zama

Kenwood Rep.; c/o
Zama PX, JAAX AAFES-PAC,
APO San Francisco 96343

Misawa

Kenwood Rep.; c/o
Misawa BX, JAAX AAFES-PAC,
APO San Francisco 96519

Yokosuka

Kenwood Rep.; c/o
A-33, Yokosuka NEX No. 260-010
FPO Seattle 98760

Atsugi

Kenwood Rep.; c/o
Atsugi NEX No. 260-020 FPO Seattle
98767

Iwakuni

Kenwood Rep.; c/o
Marine Corps Exchange, Marine Corps
Air Station,
FPO Seattle 98764

Sasebo

Sasebo NEX;
Navy Exchange 260-040
F.A. Box 115 FPO Seattle 98766

Okinawa

Kenwood Rep.; c/o
OWAX, AAFES-PAC, APO San Francisco
96230

KOREA:

Kenwood Rep.; c/o
KOAX Repair Shop, AAFES-PAC
DD-Camp Market, APO San Francisco
96488

GUAM:

Kenwood Rep.; c/o
Guam NEX No. 230-010,
FPO San Francisco 96630
Kenwood Rep.; c/o
GUAX, AAFES-PAC, APO San Francisco
96334

U.S.A.:

In The Continental U.S.A.
For Nearest Authorized Service Center;
Tel: 1-800-536-9663
www.us.jvckenwood.com

EUROPE:

Please inquire at the military resale outlets where you bought your Kenwood products, or
JVCKENWOOD DEUTSCHLAND GMBH:
Konrad-Adenauer Allee 1-11, 61118 Bad Vilbel, Germany

Warranty Card

Identification du produit
Modelo do aparelho e numero de série
Model number & serial number

Revendeur & cachet
Nome da loja e carimbo
Dealer & stamp

Date d'achat
Data da compra
Purchase date

Nom & adresse du client
Nome e endereço do cliente
Name & address of customer

Attention:

This card and receipt (or invoice) are necessary to purchase a new panel in case of theft or damage.

Attention:

Vous aurez besoin de cette carte et du reçu (ou de la facture) pour acheter un nouveau panneau en cas de vol ou d'endommagement.

Atenção:

Em caso de dano ou perda do painel frontal, este Certificado de Garantia e a Nota Fiscal de compra serão requisitados para a aquisição de um novo painel.

© B46-0824-00/06 (K) (22/04)

KENWOOD

Dear Customer,

Thank you for purchasing this Kenwood product. As mentioned in the pages of this booklet, our warranty is only valid in the countries listed. If your country is not listed please contact your retailer for information on warranty procedure, or write to:

JVC KENWOOD Customer Information Center

3-12, Moriyacho, Kanagawa-ku, Yokohama-shi, Kanagawa 221-0022, Japan

U.S.A. JVCKENWOOD USA Corporation

This warranty will be honored only in the U.S.A.

KENWOOD LIMITED WARRANTY FOR CAR STEREO COMPONENTS

HOW LONG IS THE WARRANTY
JVCKENWOOD USA Corporation ("Kenwood") warrants this product for a period of one (1) year from the date of original purchase.

WHAT IS COVERED AND WHAT IS NOT COVERED

Except as specified below, this warranty covers all defects in material and workmanship in Kenwood car stereo components. The following are not covered by the warranty:

- Any product which is not distributed in the U.S.A. by Kenwood or which is not purchased in the U.S.A. from an authorized Kenwood car stereo dealer or an automobile dealer, unless the product is purchased through the U.S.A Military Exchange Service.
- Any product on which the serial number has been defaced, modified or removed.
- Damage, deterioration or malfunction resulting from:
 - Any shipment of the product (claims must be presented to the carrier).
 - Installation or removal of the product.
 - Accident, acts of nature, misuse, abuse, neglect, unauthorized product modification or failure to follow instructions supplied with the product.
 - Repair or attempted repair by anyone not authorized by Kenwood.
 - Any other cause which does not relate to a product defect.

WHO IS PROTECTED

This warranty is enforceable only by the original purchaser.

WHAT WE WILL PAY FOR

We will pay for all labor and material expenses for covered items. Payment of shipping charges is discussed in the next section of this warranty.

HOW TO OBTAIN WARRANTY SERVICE

If your KENWOOD product ever needs service:
1. Take or ship it to any KENWOOD Authorized Service Center in the U.S.A. along with a complete description of the problem. (If you are uncertain as to whether a Service Center is authorized, please call 1-800-KENWOOD for the nearest Service Center, 1-800-536-9663).

- Although you must pay any shipping charges if it is necessary to ship the product for warranty service, we will pay the return shipping charges if the repairs are covered by the warranty within the United States.
- Whenever your units are taken or sent for warranty service, you must include a copy of the original dated sales receipt as proof of warranty coverage.

LIMITATION OF IMPLIED WARRANTIES

ALL IMPLIED WARRANTIES, INCLUDING WARRANTIES OF MERCHANTABILITY AND FITNESS FOR A PARTICULAR PURPOSE, ARE LIMITED IN DURATION TO THE LENGTH OF THIS WARRANTY.

EXCLUSION OF DAMAGES

KENWOOD'S LIABILITY FOR ANY DEFECTIVE PRODUCT IS LIMITED TO THE REPAIR OR REPLACEMENT OF THE PRODUCT AT OUR OPTION. KENWOOD SHALL NOT BE LIABLE FOR:

- INSTALLATION OR REMOVAL CHARGES, DAMAGE TO OTHER PROPERTY CAUSED BY ANY DEFECTS IN KENWOOD CAR STEREO COMPONENTS, DAMAGES BASED UPON INCONVENIENCE, LOSS OF USE OF THE PRODUCT; OR
 - ANY OTHER DAMAGES, WHETHER INCIDENTAL, CONSEQUENTIAL OR OTHERWISE.
- SOME STATES DO NOT ALLOW LIMITATIONS ON HOW LONG AN IMPLIED WARRANTY LASTS AND/OR DO NOT ALLOW THE EXCLUSION OR LIMITATION OF INCIDENTAL OR CONSEQUENTIAL DAMAGES, SO THE ABOVE LIMITATIONS AND EXCLUSIONS MAY NOT APPLY TO YOU.

This warranty gives you specific legal rights, and you may also have other rights which vary from state to state.

If a problem develops during or after the Limited Warranty Period, or if you have any questions regarding the operation of the product, you should contact your KENWOOD Authorized Dealer or Authorized Service Center. If the problem or your question is not handled to your satisfaction, please contact our Customer Relations Department at the address listed below:

JVCKENWOOD USA Corporation
PO Box 22745 Long Beach, CA 90801 (mail)
4001 Worsham Avenue Long Beach, CA 90808
Tel: (800) 536-9663
www.us.jvckenwood.com

BRASIL JVC KENWOOD DO BRASIL COMÉRCIO DE ELETRÔNICOS LTDA

O fabricante garante o produto identificado na Nota Fiscal de venda ao consumidor contra qualquer defeito de fabricação ou de matéria-prima durante o período de garantia. Esta garantia é válida no território brasileiro desde que o produto tenha sido adquirido no Brasil e distribuído pela JVC KENWOOD do Brasil Comércio de Eletrônicos Ltda.

PERÍODO DE GARANTIA

Este produto é garantido pelo prazo de 01 (um) ano, incluindo o período estabelecido por lei, a partir da data de aquisição, comprovada mediante a apresentação da respectiva Nota Fiscal de venda ao consumidor final. Eventuais reparos realizados no produto durante o período de garantia não implicam na dilatação do seu prazo.

EXCLUSÃO DA GARANTIA

- Produtos com o número de série ou certificado de garantia rasurados, adulterados ou ilegíveis;
- Defeitos resultantes de acidentes (quedas, batidas e etc), uso em desacordo com o manual de instruções, má utilização, ligação à fonte de tensão diferente da especificada no Manual de Instruções, modificações não autorizadas;
- Danos causados por agentes da natureza (Ex: chuvas, raios, maresia, enchentes e etc);
- Defeitos ou danos em decorrência de consertos realizados por pessoas não autorizadas;
- Defeitos ou danos resultantes do uso de peças ou dispositivos não conformes às especificações da JVC KENWOOD;
- Danos ou deteriorações aos acabamentos externos, partes cosméticas, cabos, chicotes, parafusos de fixação, luvas, alças, bolsas, estojos, adaptadores, antenas, fitas, cabecças gravadoras, CDs ou danos causados por pilhas defeituosas ou com vazamento;
- Defeitos ou danos devido ao transporte (reclamações devem ser feitas junto à empresa transportadora);
- Qualquer outra causa que não esteja relacionada a defeitos de matéria-prima e de fabricação;
- Danos causados por tentativa de roubo ou furto;
- Danos causados por uso de CDs de má qualidade;
- Danos decorrentes do desgaste natural do produto;
- Danos causados por mau uso. (derramamento de líquidos e/ou alimentos, corrosão, oxidação, exposição à umidade ou situações climáticas extremas, riscos ou quedas).

CONCERTO EM GARANTIA

É indispensável a apresentação deste Certificado de Garantia devidamente preenchido, acompanhado da respectiva Nota Fiscal de compra do produto, desde que não apresente rasuras ou modificações. O consumidor somente terá direito a estes benefícios, quando o produto for entregue diretamente no balcão de um Serviço Autorizado da JVC KENWOOD.

O QUE NÃO É COBERTO PELA GARANTIA

Instalação e remoção do produto, despesas de frete, seguro e embalagem são de responsabilidade do proprietário.

Este produto é destinado exclusivamente ao uso doméstico.

IMPORTANTE:

Para qualquer informação sobre seu equipamento JVC KENWOOD, ou para obter o endereço do Serviço Autorizado mais próximo, acesse o site www.kenwood.com.br, ou ligue para a Central de Atendimento JVC KENWOOD – Tel.: +55 (11) 3777-6771 com os dados abaixo preenchidos.

JVC KENWOOD DO BRASIL COMÉRCIO DE ELETRÔNICOS LTDA
Tel: (11) 3777-6771
www.kenwood.com.br

Nome do consumidor: _____

Endereço: _____ CEP: _____

Cidade: _____ Estado: _____

Telefone: _____

Data da compra: ____ / ____ / ____ Nota Fiscal: _____

CANADA JVCKENWOOD Canada Inc.

KENWOOD WARRANTY

JVCKENWOOD Canada Inc. (hereinafter called "KENWOOD"), gives the following written warranty to the original customer of each new Kenwood product distributed in Canada by KENWOOD and purchased from a dealer authorized by KENWOOD.

KENWOOD warrants that each new Kenwood product, under normal use, is free from any defects, subject to the terms and conditions set forth below. If a defect should occur within the warranty period, repairs will be made free of charge for parts and labour when such defects are determined by KENWOOD or its' authorized service centres to be attributable to faulty materials or workmanship at time of manufacture. Please contact KENWOOD to confirm if a dealer or service centre is authorized by KENWOOD.

WARRANTY PERIOD

This Kenwood product is warranted for parts and labour for a period of one (1) year from the date of original purchase, lease or rental, except for products which are used in a professional or commercial application, which are warranted for a period of ninety (90) days for parts and labour and are subject to the terms and conditions of the warranty.

WARRANTY EXCLUSIONS

- This warranty excludes:
- Products purchased in a foreign country or purchased in Canada and taken to a foreign country.
 - Products purchased from a dealer not authorized by KENWOOD.
 - Products with the serial number defaced, altered or missing.
 - Periodic check-ups which do not disclose any defects covered by this warranty.

- Defects resulting from disaster, accident, abuse, misuse, lightning, power surges, neglect or lack of periodic maintenance, unauthorized modification or failure to follow instructions in the owner's manual.
- Defects or damage as a result of repairs performed by a person or party not authorized by KENWOOD.
- Defects resulting from the use of parts or devices that do not conform to KENWOOD specifications.
- Damage or deterioration occurring to any exterior finishes, cosmetic parts, tape heads, adaptors, antennas, cables, tapes, discs or faults or damage caused by defective or leaking batteries.
- Defects or damage occurring during shipping (claims should be presented to the shipping company).
- Product voltage and /or line frequency conversions.
- Product installation or removal charges.

TO OBTAIN WARRANTY SERVICE

Should your Kenwood product require warranty service, deliver it to any authorized KENWOOD service centre and present the original copy of your bill of sale and this warranty card as proof of warranty, or send your product fully insured and freight prepaid to the nearest authorized KENWOOD service centre. To avoid possible shipping damage, make sure the product is properly packed. Include a copy of your original bill of sale and this warranty card as proof of warranty along with your name, home and /or work telephone number(s), a complete return address and a detailed description of the fault(s). Products repaired within warranty will be returned freight prepaid to destinations within Canada. The customer is responsible for all freight and related costs for the return of product(s) to destinations outside Canada.

GARANTIE KENWOOD

JVCKENWOOD Canada Inc. (ci-après appelée "KENWOOD"), donne par écrit la garantie suivante à l'acheteur original de chaque nouveau produit Kenwood distribué au Canada par KENWOOD et acheté à un concessionnaire autorisé par KENWOOD.

KENWOOD garantit, sous réserve des termes et des conditions énoncés ci-dessous, que chaque nouveau produit Kenwood, dans des conditions d'emploi normales, est exempt de tous défauts. Si l'un défaut se produit pendant la période de garantie, KENWOOD s'engage à assumer le coût des pièces défectueuses et de la main-d'œuvre nécessaires pour effectuer les réparations pourvu que de tels défauts sont attribuables à des pièces défectueuses employées lors de la fabrication du produit Kenwood ou à la main-d'œuvre tel qu'établi par KENWOOD ou par l'un de ses centres de service autorisés. Appelez KENWOOD pour vérifier si un concessionnaire ou un centre de service est autorisé par KENWOOD.

PÉRIODE DE GARANTIE

Les pièces et la main-d'œuvre nécessaires pour la réparation des produits Kenwood sont garanties pendant la période d'un (1) an à compter de la date d'achat, de bail ou de location originale, sauf dans les cas où les produits Kenwood sont employés dans un but professionnel ou commercial, où la garantie des pièces et de la main-d'œuvre demeure en vigueur pendant une période de quatre-vingt-dix (90) jours sous réserve des termes et des conditions de la garantie.

EXCLUSIONS DE GARANTIE

- Cette garantie ne couvre pas:
- les produits achetés à l'étranger ou achetés au Canada et transportés à l'étranger;
 - les produits achetés à un concessionnaire non autorisé par KENWOOD;
 - les produits dont le numéro de série manque, a été effacé ou modifié;
 - les services d'entretien périodiques qui n'indiquent aucun défaut couvert par cette garantie;

- les défauts causés par les désastres, les accidents, les abus, les emplois incorrects, les éclairs, les surtensions de courant, les travaux de soins ou d'entretiens périodiques, les modifications non autorisées ou les manques de respect du mode d'emploi;
- les défauts ou les dommages causés lors de réparations effectuées par une personne ou par une partie non autorisée par KENWOOD;
- les défauts causés par l'emploi de pièces ou de dispositifs qui ne se conforment pas aux exigences de KENWOOD;
- les finitions extérieures, les pièces cosmétiques, les têtes de bandes, les adaptateurs, les antennes, les câbles, les bandes, les disques endommagés ou déperis, ni les défauts ou dommages causés par des piles défectueuses ou qui fuient;
- les défauts ou dommages qui se produisent pendant l'expédition des produits Kenwood (On devrait déposer de telles réclamations auprès des compagnies de transport);
- les conversions de tension et/ou de fréquence du produit;
- les frais d'installation ou d'enlèvement du produit.

COMMENT OBTENIR DU SERVICE SOUS GARANTIE

Au cas où un service sous garantie de votre produit Kenwood s'avère nécessaire, veuillez livrer le produit à n'importe quel centre de service KENWOOD et présenter la copie originale du contrat de vente et cette carte de garantie en tant que preuve de garantie ou veuillez faire parvenir votre produit assuré et port payé au centre de service KENWOOD autorisé le plus proche. Pour éviter toutes possibilités de dommages pendant le transport, veuillez bien emballer le produit. Veuillez inclure une copie du contrat de vente original et cette carte de garantie en tant que preuve de garantie aussi bien que votre nom, numéros de téléphone au poste de travail et/ou au domicile, votre adresse et une description détaillée des défauts. Les produits sous garantie réparés seront retournés port payé aux destinations à l'intérieur du Canada. Le consommateur sera responsable de tous frais de transport et d'autres frais qui s'y rapportent pour faire expédier les produits à destinations à l'extérieur du Canada.

ENTIRE WARRANTY

This warranty constitutes the entire written warranty given by KENWOOD. No person, party, dealer or service centre or their agents or employees are authorized to extend or enlarge this warranty on behalf of KENWOOD by any written or verbal statement or advertisement or promotion, including any extended warranty program or plan that may be offered by the dealer or service centre, unless approved in writing by KENWOOD.

DISCLAIMER

KENWOOD disclaims any responsibility for loss of time or use of the product or any other indirect, incidental or consequential damage to other products or goods, inconvenience or commercial loss.

NOTICE TO CONSUMER

The provisions contained in this written warranty are not intended to limit, modify, take away, disclaim or exclude any warranties or rights you may have which are set forth in any applicable provincial or federal laws or legislation.

IMPORTANT

This warranty card by itself is not considered by KENWOOD as a valid proof of purchase. When applying for warranty repairs, you must present the original copy of your bill of sale and this warranty card as proof of warranty, so we recommend that they be kept in a safe place, should they be required in the future.

JVCKENWOOD Canada Inc.

6685 Millcreek Drive, Unit 8, Mississauga, Ontario, L5N 5M5, Canada
Tel.: (905) 670-7211
Fax: (905) 670-7248

E-mail: customerservice@ca.jvckenwood.com
Product Registration:
<https://myjvckenwood.ca>

L'ENTIERE GARANTIE

Cette garantie représente l'entière garantie donnée par écrit par KENWOOD. KENWOOD ne se tient aucunement responsable de toutes extensions ni de toutes augmentations de cette garantie faites ou entreprises par toutes personnes, parties, concessionnaires ou centres de service ou par leurs agents ou employés au nom de KENWOOD au moyen d'affirmations verbales ou écrites, d'annonces ou de promotions, y inclus tous programmes ou plans de garantie étendue que puissent offrir les concessionnaires ou les centres de service, à moins que KENWOOD n'y ait consenti par écrit d'avance.

RENONCIATION

KENWOOD renonce à toutes responsabilités de perte de temps, d'emploi du produit, de tous dommages indirects ou accessoires causés à d'autres produits ou biens, de tous inconvénients ou de toutes pertes commerciales.

AVIS AUX CONSOMMATEURS

Les stipulations contenues dans la présente garantie écrite n'ont pas pour but de limiter, de modifier, de diminuer, de rejeter ni d'exclure d'autres garanties ni droits énoncés dans n'importe quelles lois ou législations provinciales ou fédérales.

IMPORTANT

KENWOOD ne considère pas cette garantie toute seule comme étant une preuve d'achat valide. Lorsqu'on demande du service sous garantie, il faudra présenter la copie originale du contrat de vente aussi bien que cette carte de garantie en tant que preuve de garantie. On recommande de les conserver dans un lieu sûr au cas où elles s'avèreraient nécessaires à l'avenir.

JVCKENWOOD Canada Inc.

6685 Millcreek Drive, Unit 8, Mississauga, Ontario, L5N 5M5, Canada
Téléphone: (905) 670-7211
Télécopieur: (905) 670-7248

E-mail: customerservice@ca.jvckenwood.com
Enregistrement De Produit:
<https://myjvckenwood.ca/fr>