



OWNER'S MANUAL

Wireless Soundbar

Please read this manual carefully before operating your set and retain it for future reference.

Model

S60TR (S60TR, SPT5-W, SPT8-S, SPT8-SPK)

Soundbar Quick Guide

| Installing and using the Product

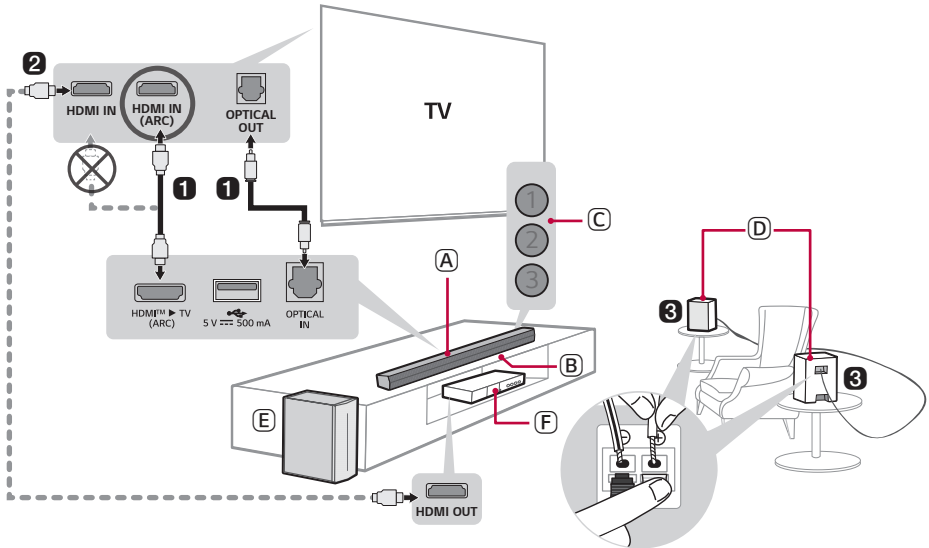

- 1** Connect the soundbar to your TV via an optical cable or an HDMI cable.



- (A) Soundbar
- (B) Remote Control Receiver
- (C) Status LED (1)(2)(3)
- (D) Rear Speakers
- (E) Wireless Subwoofer - Install it close to the soundbar.
- (F) External Device - (Blu-ray player, game console, etc.)

- 2 If you are using an external device (ex. Set-top box, Blu-ray player, game console, etc.), connect it to the TV via an HDMI cable.
- 3 Connect the rear speakers via a speaker cable. When connecting the rear speakers, connect the black striped cable to the negative terminal of each speaker and the remaining cable to the positive terminal of each speaker.
- 4 Connect to power in the following order: wireless subwoofer → rear speakers → soundbar. Then, turn on the soundbar. When the connection is automatically established with the soundbar, the LEDs on the wireless subwoofer and the rear speakers will light up in green. (→ See "Connecting the Product" on page 6.)

5 Connecting the product to your smartphone via Bluetooth (→ See "Connecting via Bluetooth" on page 38.)

- 1 Tap the **Settings**  button on your smartphone and select **Bluetooth**. Turn on the **Bluetooth** function. (Off > On)
- 2 Press the **Bluetooth pair**  button. After a moment, LED1 and LED2 blink white.
- 3 Find and select the product on your smartphone. The product appears as "LG S60TR(XX)".
- 4 When the product is connected to your smartphone via **Bluetooth**, LED1 and LED2 light up white.

6 Connecting to the LG Soundbar app (→ See "Connecting with a Smartphone via LG Soundbar app" on page 41.)

- 1 Find and install the **LG Soundbar app** on Google Play or App Store from your smartphone.
- 2 You can get more information regarding its use by selecting [Help] in [Setting].

Manually connecting the soundbar to the wireless subwoofer or rear speakers (→ See “Connecting the wireless subwoofer manually”, “Connecting the rear speakers manually” on page 8, 11.)

If you see a red LED on the wireless subwoofer or rear speaker, it means that the soundbar is not connected to the speakers. If this is the case, connect them in the following order.

- ① Press the **Power** (⏻) button on the soundbar to turn it off.
- ② Press the **PAIRING** button on the back of the wireless subwoofer or rear speaker. Check if each LED blinks green.
 - If you still see a red LED on the wireless subwoofer, press and hold the button on the back of the subwoofer again.
- ③ Press the **Power** (⏻) button on the soundbar to turn it on.
- ④ When the connection is established, you will see a green LED light on the wireless subwoofer or rear speaker light up.

Table of Contents

Soundbar Quick Guide

- 2 Installing and using the Product

Installation

- 6 Connecting the Product
- 13 Setting up surround sound

Exploring the Product

- 17 Front
- 22 Back
- 23 Exploring Remote Control

Various settings for convenience

- 26 Convenient functions
- 27 How to change the settings
- 28 Sound tuning
- 29 Voice feedback function

Connecting to the TV

- 30 Connecting with an Optical Cable
- 32 Connecting via Bluetooth
- 33 Connecting with an HDMI Cable

Connecting to an External Device

- 35 Connecting with an HDMI Cable
- 37 Connecting with an Optical Cable

Using the Product as an Audio System

- 38 Connecting via Bluetooth
- 41 Connecting with a Smartphone via LG Soundbar app
- 43 Connecting to a USB Storage Device

Mounting the Product to a Wall

- 45 Checking before mounting to a wall
- 47 Mounting the Product to a Wall

Safety Precautions

- 49 Safety and Regulatory
- 52 Prevention of product misuse

Before Reporting Product Malfunction

- 56 Troubleshooting

Appendix

- 59 Specifications
- 61 Registered Trademarks and Licenses
- 62 Open Source Software Notice Information
- 63 Handling the Product

Installation

Connecting the Product

You can enjoy a richer sound by connecting the soundbar to the wireless subwoofer.

Connecting the wireless subwoofer automatically

After completing installation, the wireless subwoofer will automatically be connected to the soundbar. Connect the soundbar to the subwoofer in the following order.

- 1 Plug the power cable into the wireless subwoofer.
- 2 Plug the power cable connected to the wireless subwoofer into an outlet.
- 3 Plug the power cable into the soundbar.
- 4 Plug the power cable connected to the soundbar into an outlet.
- 5 Press the **Power** (⏻) button on the soundbar to turn it on.

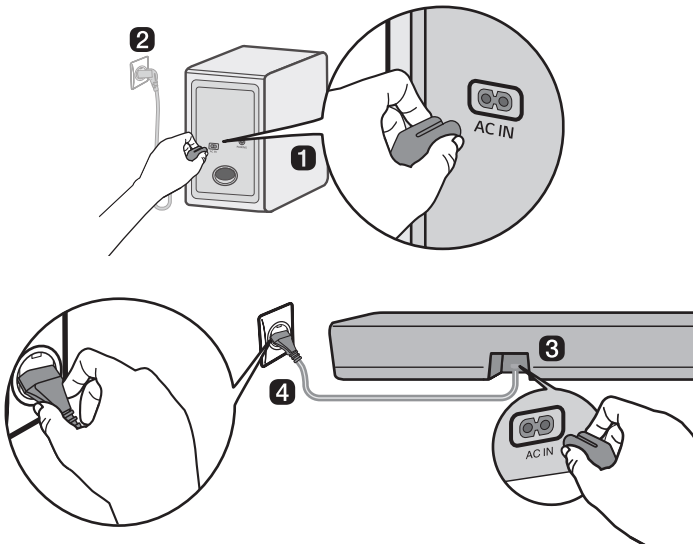

- 6 When the connection is automatically established, you will see the LED on the wireless subwoofer light up in green.

Checking the connection with the LED on the wireless subwoofer

You can check the connection status by looking at the LED on the wireless subwoofer.

LED Color	Status
Blinking green	Connecting in progress
Green	Connected successfully
Red	Bad connection, or the subwoofer is in standby
Off	Power cable not connected

Connecting the wireless subwoofer manually

If you see a red LED on the wireless subwoofer, it means that the soundbar is not connected to the subwoofer. If this is the case, connect them in the following order.

- 1 Press the **Power** (⏻) button on the soundbar to turn it off.
- 2 Press the **PAIRING** button on the back of the wireless subwoofer. Check if the LED on the subwoofer is blinking green. If you still see a red LED on the wireless subwoofer, press and hold the button on the back of the subwoofer again.

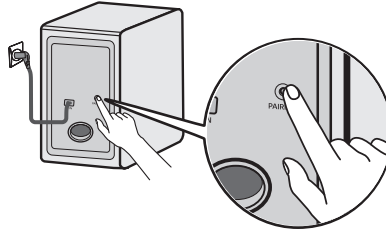

- 3 Press the **Power** (⏻) button on the soundbar to turn it on.
- 4 When the connection is established, you will see the LED light on the wireless subwoofer light up in green.

✓ Note

- Install the soundbar as close to the wireless subwoofer as possible. The closer the distance between the soundbar and the wireless subwoofer, the better the sound quality.
- Please ensure there are no obstacles between the soundbar and the wireless subwoofer.
- To prevent wireless interference, maintain a distance of at least 1 m (3.3 ft) between the soundbar or the wireless subwoofer and any peripheral devices that generate strong electromagnetic waves (ex. wireless routers, microwave ovens, etc.).

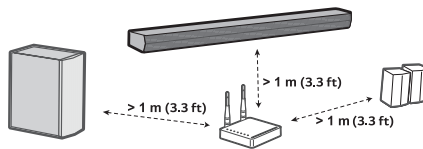

Connecting the rear speakers

Automatic connection

After completing installation, the rear speakers will automatically be connected to the sound bar. Connect the sound bar to the rear speakers in the following order.

- 1 Connect the speaker cables to the corresponding terminals on the rear speakers (left, right). Connect the black striped cable to the negative terminal and the other cable to the positive terminal.

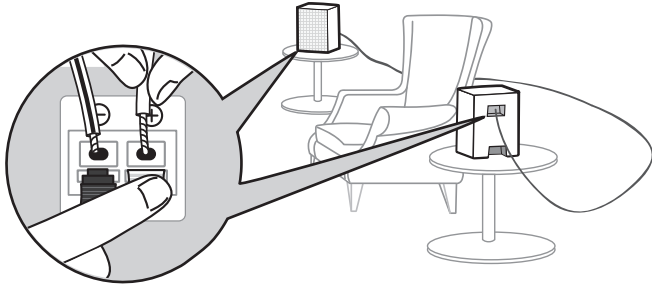

- 2 Plug the power cable into the rear speaker.
- 3 Plug the power cable connected to the rear speaker into an outlet.
- 4 Press the **Power** (⏻) button on the sound bar to turn it on.
- 5 When the connection is automatically established, you will see the LED on the rear speaker light up in green.

✔ **Note**

- Please only use the speakers provided with the product. Using other speakers may cause malfunction.
- Connect the speaker cables to the corresponding terminals. Connect to the positive cable to the positive terminal and the negative cable to the negative terminal. An incorrectly connected cable will distort the sound or produce no bass.
- Connect the product to the speakers and cables provided at the time of product purchase.
 - If you connect the product to speakers or cables other than those provided at the time of product purchase, there can be a deterioration of sound quality or a speaker malfunction.
- When you connect speakers to the product, connect only one speaker to the output port that fits the speaker.
 - If you connect multiple speakers to one output port, it may cause a product or speaker malfunction.
- If the position of the power plug is different during rear speakers installation, you can change the position of the L/R channel of rear speaker's through the **LG Sound Bar app**.

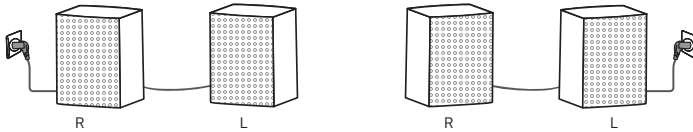

Checking connection status with the LED color

You can check the connection status with the LED on the rear speaker.

LED Color	Status
Blinking green	Connecting In progress
Green	Connected successfully
Red	Bad connection, or the rear speakers are in standby
Off	Power cable not connected

Connecting the rear speakers manually

If you see a red LED on the rear speaker, it means that the sound bar is not connected to the rear speakers. If this is the case, connect them in the following order.

- 1 Press the **Power** (⏻) button on the sound bar to turn it off.
- 2 Press the **PAIRING** button on the back of the rear speaker. Check if the LED on the rear speaker is blinking green.

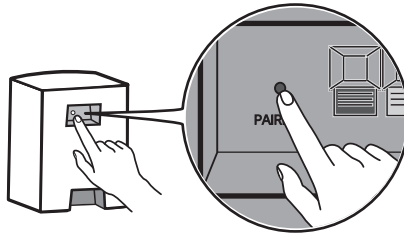

- 3 Press the **Power** (⏻) button on the sound bar to turn it on.
- 4 When the connection is established, you will see the LED light on the rear speaker light up in green.

✔ Note

- Keep the rear speakers at least 30 cm (11.8 inch) away from the TV or monitor.
- To prevent wireless interference, maintain a distance of at least 1 m (3.3 ft) between the sound bar or the rear speakers and any peripheral devices that generate strong electromagnetic waves (ex. wireless routers, microwave ovens, etc.).

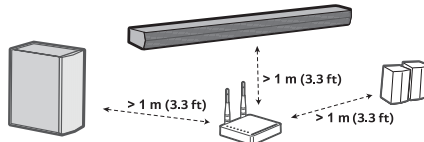

Organising cables (Optional)

You can organise the speaker cable with supplied cable ties.

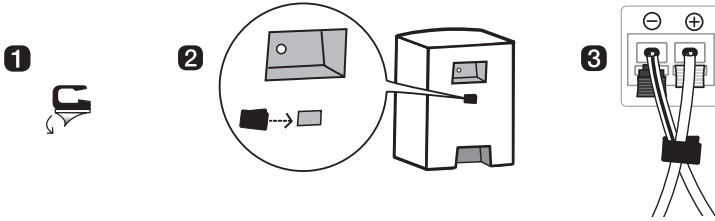

✔ Note

- After all connections are completed, you can arrange cables as needed.
-

Setting up surround sound

The surround sound function allows you to hear immersive 3D sound produced by multiple audio channels from the speakers, regardless of the channels in the originally recorded content.

For example, if you listen to music recorded in 2.0 channels with standard sound effects, you can hear the following difference.

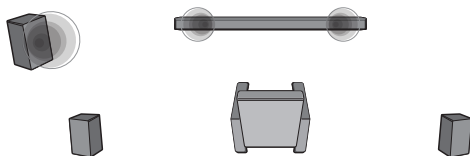

When the surround sound is off

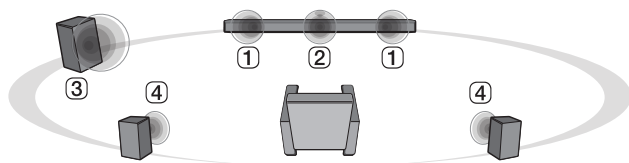

When the surround sound is on

✔ Note

- Speaker positions are as follows.

- ① Front speakers
 - ② Center speaker
 - ③ Subwoofer
 - ④ Rear speakers
-

Turning surround sound on/off

1 Press **Settings**  button. LED2 blinks white.

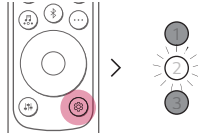

2 While the LED2 is blinking, press **Left/Right** button to choose the surround sound setting.

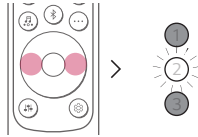

3 While the LED2 is blinking, press **Up/Down** button. If the surround sound setting is on, LED1 blinks white. If the surround setting is off, LED3 blinks white.

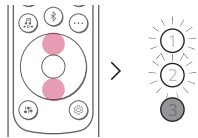



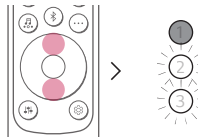











(On)

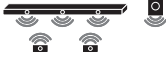

(Off)

Speaker sound based on input channels

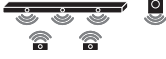
Sound Effects		
Input	Output	
	Rear speakers not connected	Rear speakers connected
AI SOUND PRO		
Sound customised with artificial intelligence		
2.0 channels		
5.1 channels		
STANDARD		
You can enjoy optimised sound		
2.0 channels		
5.1 channels		
MUSIC		
You can enjoy better sound optimised for music.		
2.0 channels		
5.1 channels		
CINEMA		
Cinematic 3D sound		
2.0 channels		
5.1 channels		

Sound Effects		
Input	Output	
	Rear speakers not connected	Rear speakers connected
CLEAR VOICE PRO		
Improves the clarity of voices		
2.0 channels		
5.1 channels		
SPORTS		
Realistic sound like in a stadium		
2.0 channels		
5.1 channels		
GAME		
Optimised sound for game		
2.0 channels		
5.1 channels		
BASS BLAST (BASS BLAST+)		
Sound with reinforced bass		
2.0 channels		
5.1 channels		

Exploring the Product

Front

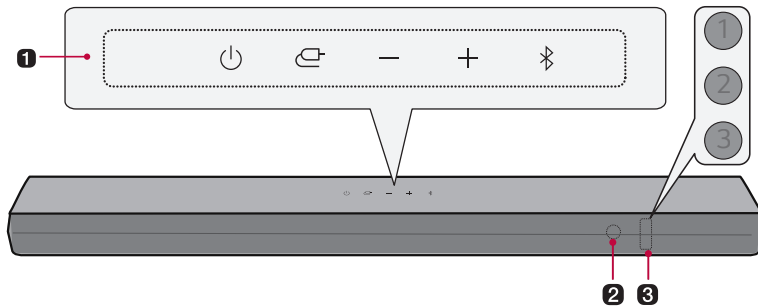

1 Power

This turns the product on/off.

Function

Press the button repeatedly to select the desired function or input mode.

- Optical/ARC: Connects the product to a TV that supports an optical cable, ARC, or LG Sound Sync
- **Bluetooth**
 - Connects the product via **Bluetooth**
 - Connects the product to a TV that supports LG Sound Sync (Wireless)
- USB: Connects the product to a USB storage device

Volume

Adjusts the sound volume.

Bluetooth pair

It allows you to pair your **Bluetooth** device such as a smartphone to this product for three minutes. (→ See "Connecting via Bluetooth" on page 38.)

2 Remote Control Receiver

This receives wireless signals from the remote control.

3 Status LED

Options such as input mode and volume light up. (→ See “Status LED” on page 19.)

- The status LED can be controlled as auto, off, and on. (→ See “Display” on page 26.)
-

✓ Note

- To reduce power consumption, the product will automatically turn off after 15 minutes of no input signal from an external device.
-

Status LED



On (White, Orange, Purple, Green, Yellow, Red)



Off



Blink

Power on / Power off

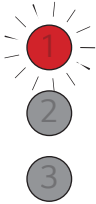

LED1 blinks red.

Volume control

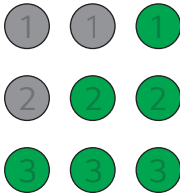

- Volume up: The LEDs get brighter and light up one by one.
- Volume down: The LEDs get darker and turn off one by one.
- The volume reaches maximum, all LEDs blink red.
- The volume reaches minimum, all LEDs turns off.
- If you press **Up/Down** button even when the level has reached the maximum or minimum, the current function LED will blink 3 times.
- The LED color changes according to the volume level.
 - 1-33: Green
 - 34-66: Yellow
 - 67-99: Red

Mute

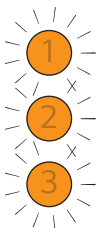

All LEDs blink orange.

Function

1

2

3

OPTICAL/HDMI ARC

LED1 lights up white.

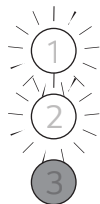

Bluetooth ready

LED1 and LED2 blink white.

1

2

3

Bluetooth

LED1 and LED2 light up white.

1

2

3

USB

LED1 lights up purple.

The other button inputs



LED2 blinks red once when you press the button: **Sound Effects** 
Information  **Up/Down / Left/Right** , **Play/Pause** 

Back

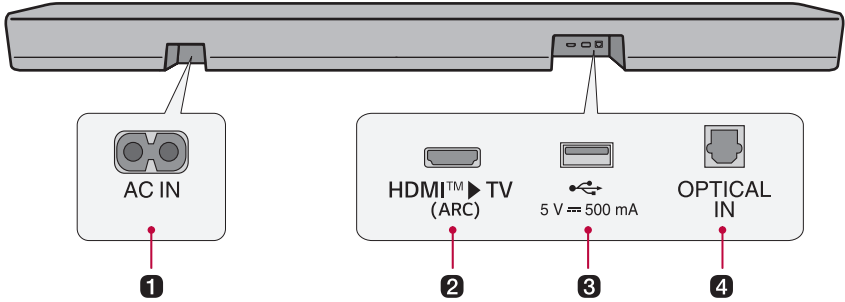

1 AC IN

Plug in the power cord.

2 HDMI™ ► TV (ARC)

Plug in an HDMI cable to connect the TV to the product.

3 USB port

Plug in a USB storage device to play music with the product.

4 OPTICAL IN

Plug in an optical cable to connect the TV to the product.

Exploring Remote Control

You can use the remote to control all functions of the product, from turning the power on/off to enabling cinematic sound.

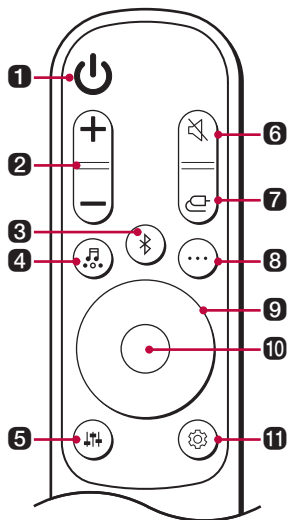

Replacement of Battery

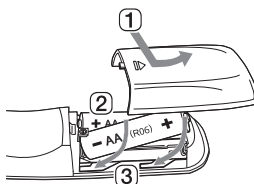

Use AA 1.5V batteries. Replace the two batteries by inserting them into the remote control in accordance with the directions indicated.

- 1 Open the battery cover on the back of the remote control.
- 2 Insert the batteries with the + and - ends corresponding to the markings.
- 3 Close the battery cover.

Risk of fire or explosion if the battery is replaced by an incorrect type.

1 Power

Turns the product on/off.

2 Volume

Adjusts the sound volume.

3 Bluetooth pair

It allows you to pair your **Bluetooth** device such as a smartphone to this product for three minutes. (→ See “Connecting via Bluetooth” on page 38.)

4 Sound Effects

Press the button to select the desired sound field.

- AI SOUND PRO: Artificial intelligence selects the optimal sound settings to suit your content.
- STANDARD: You can enjoy optimized sound.
- CINEMA: Play content with 3D sound similar to a movie theater.
- CLEAR VOICE PRO: Improves the clarity of voices.
- SPORTS: Realistic sound like in a stadium.
- MUSIC: You can enjoy better sound optimized for music.
- GAME: Optimized sound for game.
- BASS BLAST (BASS BLAST+): Bass sounds are enhanced.

5 Sound Tuning

This adjusts the sound level of the connected speaker. Press the **Sound Tuning**  button and then **Left/Right** button to select the desired speaker before you press the **Up/Down** button to increase/decrease the sound volume. Adjustable speakers and adjustment ranges are as follows:

- Subwoofer: -15 ~ 6
 - Center: -6 ~ 6
 - Rear: -6 ~ 6
 - Treble: -6 ~ 6
 - Mid: -6 ~ 6
 - Bass: -6 ~ 6
- Adjusting subwoofer level is applied only when the subwoofer is connected.

6 Mute

This turns off the sound from the product.

7 Function

Press the button repeatedly to select the desired input mode or function.

8 Information

Speak the connected input source or **Bluetooth** information.

- **Bluetooth**: If a **Bluetooth** device is connected, you will hear "Paired" (Paired).
 - Optical/ARC: Current sound source.
 - USB: If no USB is connected, you will hear "No USB" (No USB).
 - Press the button for longer than 5 seconds to turn on or off the voice feedback. (English voice only) (→ See "Voice feedback function" on page 29.)
-

9 Up/Down/Left/Right Ⓞ

These buttons are used to adjust the settings of the convenient functions.

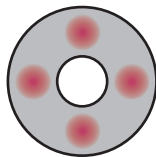

Left/Right: To play the previous song, press **Left** button. To play the next song, press **Right** button.

10 Play/Pause ⏸

To play or pause a song, press this button.

- When listening to music on a USB storage device, you can select the play mode by pressing this button for 3 seconds or longer, then press the button repeatedly to select the desired Repeat option.
 - REPEAT ONE: Plays the current file repeatedly
 - REPEAT FOLDER: Only plays the files in the folder on a loop
 - REPEAT ALL: Plays all files on a loop
 - REPEAT SHUFFLE: Plays a random file until all files are played, then ends playback
 - REPEAT OFF: Plays the files in order, then ends playback
-

11 Settings ⚙

It allows you to adjust the settings of this product: AUTO POWER, SURROUND, NIGHT TIME, DISPLAY, REAR CH CHANGE. Press **Settings** ⚙ button and select the setting by using **Left/Right** button before you press the **Up/Down** button to turn on/off the setting.

- AUTO POWER: When the TV or an external device is turned on or off, the product will also turn on or off automatically. It is available only when the product is connected to the TV with an optical cable. (→ See "Auto Power" on page 26.)
 - SURROUND: The surround sound function allows you to hear immersive 3D sound produced by multiple audio channels from the speakers, regardless of the channels in the originally recorded content. (→ See "Turning surround sound on/off" on page 14.)
 - NIGHT TIME: This reduces the general sound volume, but raises the volume of soft and delicate sounds. This is useful when enjoying music or a movie late at night. (→ See "Night Time" on page 26.)
 - DISPLAY: The status LED can be controlled as auto, off, and on. (→ See "Display" on page 26.)
 - REAR CH CHANGE: You can change the rear speaker position as you like. (→ See "Rear channel change" on page 26.)
-

Various settings for convenience

| Convenient functions

Auto Power

This function automatically turns the product on or off when the TV or external device is turned on or off. When the connected device is turned on, the product turns on automatically and selects a function according to the input signal.

Night Time

This reduces the general sound volume, but raises the volume of soft and delicate sounds. This is useful when enjoying music or a movie late at night.

Display

The status LED can be controlled as auto, off, and on.

Option	LED Status
Auto	Dimmed after 20 seconds of button input.
Off	Turned off after 20 seconds of button input.
On	Always on

Rear channel change

You can change the speaker position as you like. If the outlet is on the left side of the soundbar, place the speaker with power cord on the left and set the speaker position.

✔ Note

- You can change the speaker position after connecting the rear speakers to the soundbar. Additionally, you can change it only if the rear speaker is turned on.
-

How to change the settings

- 1 Press **Settings**  button. The product enters the setting mode and LED2 blinks white.

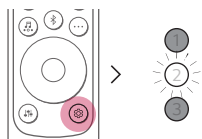

- 2 While the LED2 is blinking, press **Left/Right** button to choose the setting you want.

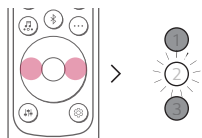

- 3 While the LED2 is blinking, press **Up/Down** button. If the setting is on or auto, LED1 blinks white. If the setting is off, LED3 blinks white.

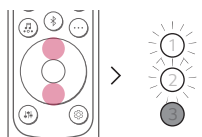

(On/Auto)

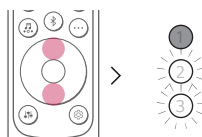

(Off)

Sound tuning

You can adjust the sound level of each speaker and sound tone.

- 1 Press **Sound Tuning**  button. The product enters the setting mode and displays the current level of the product.
- 2 Press **Left/Right** button to choose the speaker you want to adjust.
- 3 Press **Up/Down** button to adjust the sound level.

Subwoofer (-15 ~ 6)

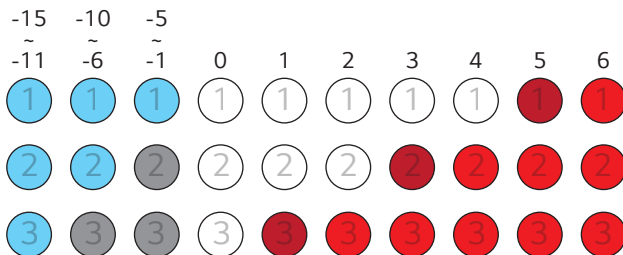

Center, Rear, Treble, Mid, Bass (-6 ~ 6)

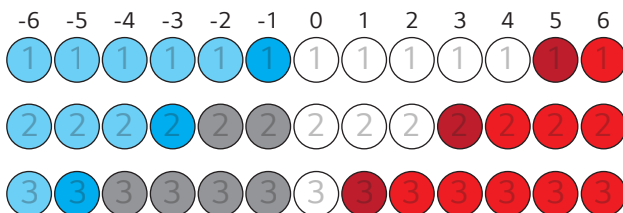

Note

- If you press **Up/Down** button even when the level has reached the maximum or minimum, the current function LED will blink 3 times.

Voice feedback function

When you select a function or sound, the current status of the product is guided by voice. (English voice only)

Press **Information**  button on the remote control for longer than 5 seconds to turn this function on or off.

✔ Note

- Voice feedback and Soundbar volume level work together up to 13. However, the voice feedback volume level doesn't increase above 13.
 - During voice feedback, all sounds except for voice feedback becomes low temporarily.
 - Regardless of setting this function, you can hear voice feedback for the settings, sound tuning, and information.
-

How to deactivate the wireless network connection(s).

Set up the Auto Power function to off and turn off the product.

Connecting to the TV

Connecting with an Optical Cable

Transmit your TV's audio to the product by connecting it to the TV with an optical cable. You can add a variety of 3D effects to the original audio to fill the room with a deep, rich sound.

Watching TV after connecting with an optical cable

- 1 If the digital cable terminal has a cover, first remove the covers from both ends.

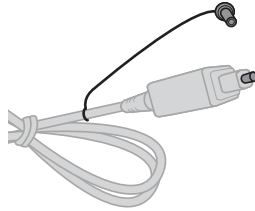

- 2 Using an optical cable, connect the **OPTICAL IN** terminal on the back of the product to the **Optical Digital Output (OPTICAL OUT)** terminal on the TV as shown in the picture.

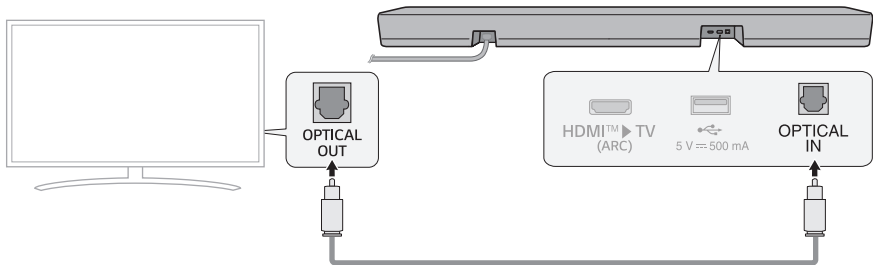

- 3 Press the **Function**  button repeatedly until LED1 lights up white.



- 4 Press the **Settings** button on the TV remote control to enter the [Speaker] menu and set the output speaker to [Optical] or [External Speaker]. Settings and menu items may vary depending on the TV manufacturer.

✔ **Note**

- If the optical input signal and the ARC signal attempt to connect at the same time, the ARC signal will take priority.
-

When you use an LG TV

You can adjust the volume with the LG TV remote control if the TV is connected to the product with an optical cable. You can only do so on a TV that supports the LG TV Sound Sync function. Check your TV's user manual to see if your TV is supported.

Functions controllable with an LG TV remote control

Volume, mute on/off

✔ **Note**

- When using the product with an LG TV remote control, the volume and mute status set on the TV will automatically be applied to the product.
 - You can still use the product's remote control even after connecting it to an LG TV.
 - To use LG Sound Sync, you may have to change the sound setting of your TV. It may vary depending on the TV.
-

Connecting via Bluetooth

You can adjust the volume with the LG TV remote control if the TV is connected to the product with LG Sound Sync (Wireless). Check out the TV user manual to see if your TV is supported.

Watching TV after connecting it wirelessly

- 1 Press the **Bluetooth pair**  button. After a moment, LED1 and LED2 blink white.
- 2 Press the **Settings** button on the TV remote control, enter to the [Speaker] menu, and connect the product to the TV.
- 3 When the product is connected to the TV via **Bluetooth**, LED1 and LED2 light up white.

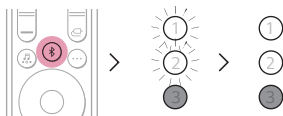

✔ Note

- When reconnecting after the first connection with LG Sound Sync, immediately lights up as a White LED.
- When using the product with an LG TV remote control, the volume and mute status set on the TV will automatically be applied to the product.
- You can still use the product's remote control even after connecting it to an LG TV.
- If you turn off the power of the product with the **Power**  button, the LG Sound Sync (Wireless) will be disconnected.
- Depending on the TV, the product may be connected to the LG TV even if it is connected with the **Bluetooth** function.

Connecting with an HDMI Cable

You can transmit TV audio to the product by connecting the TV to the product with an HDMI cable. Add a variety of 3D effects to the original audio to fill the room with a deep, rich sound.

Watching TV after connecting with an HDMI cable

- 1 Using the HDMI cable, connect the **HDMI™ ► TV (ARC)** terminal on the back of the product to the **HDMI IN (ARC)** terminal on the TV as shown in the picture.

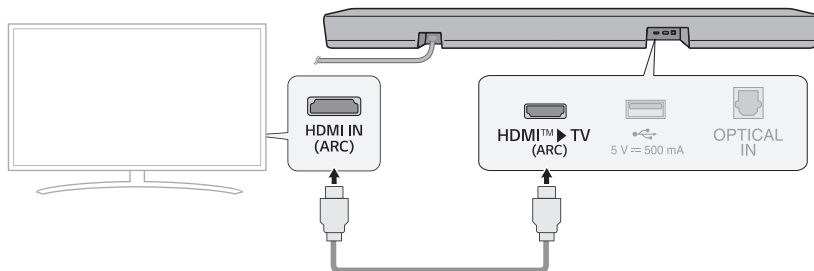

- 2 Press the **Function**  button repeatedly until LED1 lights up white.

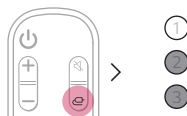

- 3 Press the **Settings** button on the TV remote control to enter the [Speaker] menu and set the output speaker to [HDMI ARC]. Settings and menu items may vary depending on the TV manufacturer.

✓ Note

- Make sure that your TV supports the ARC function before you press the Setting button on the TV remote control and turn on ARC. For more information on how to set the function, refer to the TV user manual as it may differ depending on the TV.
- Use a certified cable with the HDMI logo.

SIMPLINK

- SIMPLINK refers to the HDMI-CEC function that allows you to use a single TV remote control to easily operate an audio device or player connected to an LG TV via HDMI.
 - Functions controllable with a SIMPLINK-compatible LG TV remote control: Power on/off, volume control, mute on/off, etc.
- For more information on how to set up SIMPLINK, consult your LG TV's user manual.



✔ Note

- The SIMPLINK function may not work properly depending on the status of the product or other connected devices.
 - HDMI-CEC features by TV manufacturer: LG SIMPLINK, Sony BRAVIA Sync/Link, Philips EasyLink, Samsung Anynet+, etc.
-

Connecting to an External Device

Connecting with an HDMI Cable

Connect the TV and external device (game console, DVD player, etc.) with an HDMI cable and enjoy a deep and rich sound.

Connecting an external device via HDMI

- 1 Connect an external device such as a Set-top box, DVD or Blu-ray player. Following the picture below, connect the **HDMI OUT** terminal of the device to the **HDMI IN** terminal on the TV.
- 2 Using the HDMI cable, connect the **HDMI™ ► TV (ARC)** terminal on the back of the product to the **HDMI IN (ARC)** terminal on the TV.

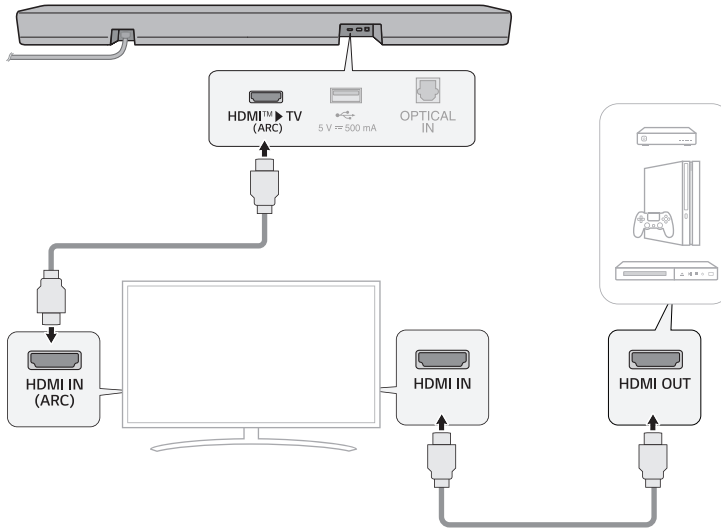

3 Press the **Function**  button repeatedly until LED1 lights up white.



4 When the external device is properly connected to the product, you can listen to the sound of the device.

✓ **Note**

- Please check the audio output settings in the Settings menu of your external device (ex. Blu-ray player or TV). The audio output should be set to [No encoding], [Bitstream], [Auto], or [Pass through]. For more information on how to set the output, please refer to your external device's user manual.
 - Use a certified cable with the HDMI logo.
-

Connecting with an Optical Cable

Connect the TV and external device (game console, DVD player, etc.) with an optical cable and enjoy a deep and rich sound.

Connecting an external device via optical cable

- 1 Use the optical cable to connect the **OPTICAL IN** terminal on the back of the product to the **OPTICAL OUT** terminal of your external device (ex. TV, Blu-ray player) as shown in the picture.

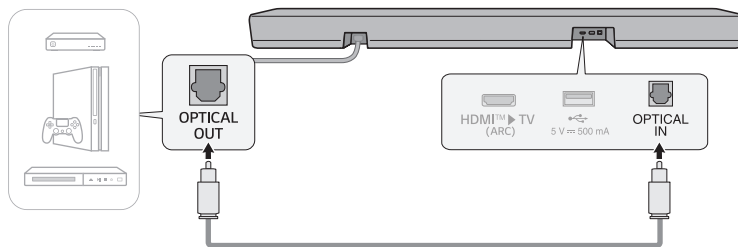

- 2 Press the **Function**  button repeatedly until LED1 lights up white.

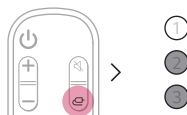

Using the Product as an Audio System

Connecting via Bluetooth

You can play music files stored on a **Bluetooth** device, or run music apps to enjoy the music with this product.

Please check the following first.



- **Bluetooth** devices to be connected to the product should meet the following specifications.
 - **Bluetooth** 5.3 technology
 - Codec: SBC, AAC
- Steps to connect the device to the product may vary depending on the **Bluetooth** device type and model. For more information on how to connect the device, please refer to your external device's user manual.

Select the [**Bluetooth**] from your smartphone's **Settings** menu.

Settings menu items may vary depending on your smartphone manufacturer and model.

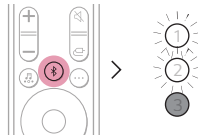
- 1 Turn on the product.
- 2 Press the **Bluetooth pair**  button. After a moment, LED1 and LED2 blink white.



- 3 Tap the **Settings**  /  button on your smartphone and select **Bluetooth**.

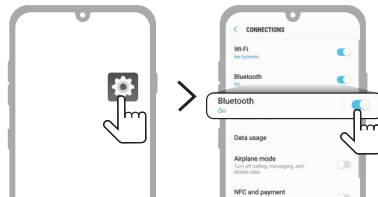

(Android Phone)

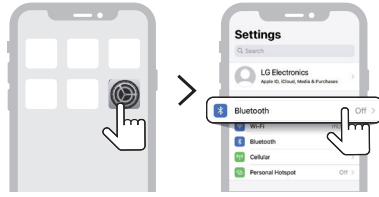

(iPhone)

- 4 Turn on the **Bluetooth** function. (Off > On)
- 5 You will see a list of connectable devices on your smartphone. Find and tap "LG S60TR(XX)".



- 6 When the product is connected to the smartphone via **Bluetooth**, LED1 and LED2 light up white.
- 7 If you cannot find the product "LG S60TR(XX)", tap the **Refresh** (🔄) button at the top right of the screen on the Android smartphone or turn the **Bluetooth** off and turn it on again on iPhone.

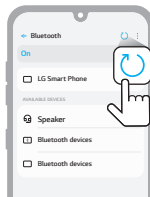

(Android Phone)

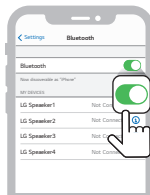

(iPhone)

- 8 Run a Music app and listen to music on the smartphone.

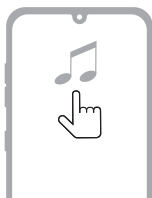

✓ **Note**

- The closer the **Bluetooth** device is to the product, the better your connection.
 - If you pressed the **Bluetooth pair** (Bluetooth symbol) button of the product and selected the “**Bluetooth**” option, but could not connect to the **Bluetooth** device, LED1 and LED2 blink white for 3 minutes. Check the status of the **Bluetooth** device.
 - When using **Bluetooth**, you should adjust the volume level to an appropriate level.
 - XX is the last 2 digits of the MAC address of the product. For example, if the MAC address is 9C:02:98:4A:F7:08, it will be displayed as “LG S60TR(08)”.
-

Connecting with a Smartphone via LG Soundbar app

Please use the **LG Soundbar app** to run various functions of the product conveniently.

Please check the following first.

- The **LG Soundbar app** is available in the versions listed below.
 - Android™ OS: Version 6.0 or higher
 - iOS OS: Version 12 or higher
 - Minimum supported versions for each OS may change later.

Installing the app

Install the **LG Soundbar app** on your smartphone. To install the **LG Soundbar app**, you can scan the QR code with a QR code scan app or download on Google Play or the App Store.

Downloading with a QR code

- 1 Scan the QR code below with a QR code scan app.
- 2 You will be directed to a page where you can download the **LG Soundbar app**. Tap the app to install it.



(Android Phone OS)



(iPhone OS)

Downloading from the Google Play or App Store

Go to the Google play or the App Store on your smartphone and search for the **LG Soundbar app** to install it.

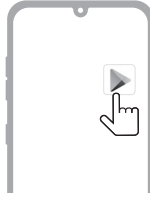

(Android Phone)

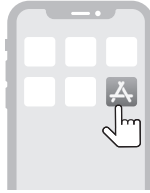

(iPhone)

✔ Note

- Settings menu items may vary depending on the smartphone manufacturer and OS.
 - Google, Android and Google Play are trademarks of Google LLC.
-

Connecting to a USB Storage Device

Enjoy high-quality sound by connecting a USB storage device containing music files to the product.

Connecting the product to a USB storage device

- 1 Plug the USB storage device into the **USB** port on the back of the product.
 - The product cannot play any devices connected via a USB storage device hub or a USB storage device cable.
 - The product cannot be connected to any USB storage device, USB type MP3 player, or card reader that requires a separate device drive to be installed.

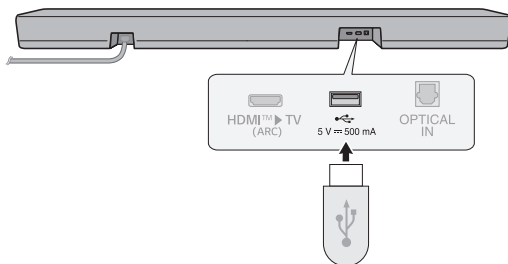

- 2 Press the **Function** button repeatedly until LED1 lights up purple.

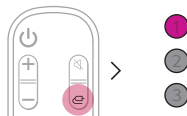

- 3 Press the **Play/Pause** button on the remote control to enjoy the music.



(Pause)

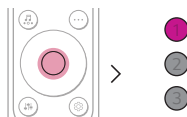

(Play)

✔ Note

- It is recommended that you purchase a separate USB gender changer to make it easier to plug in and out USB storage devices.
- Purchase a USB gender changer with a USB 2.0 extension cable.
- USB devices with a large storage volume may take several minutes to browse through files.
- LG Electronics is not responsible for any data loss. Please always back up the data on your USB storage device to minimize damage caused by data loss.
- Only FAT16/FAT32/NTFS formats are supported. exFAT format is not supported.
- Use the USB port of this product only for playing a media file. You cannot charge external devices with the USB port.

USB storage devices supported

- MP3 player
- Flash MP3 player
- USB flash device
- USB 2.0

This product may not recognize some USB storage devices.

Playable file specifications

File extension	Sampling frequency / Bitrate
MP3	32 kHz - 48 kHz / 8 kbps - 320 kbps
WMA	32 kHz - 48 kHz / 5 kbps - 330 kbps
OGG	32 kHz - 48 kHz / 30 kbps - 500 kbps

File extension	Sampling frequency
FLAC (16 bit/24 bit)	32 kHz, 44.1 kHz, 48 kHz, 88.2 kHz, 96 kHz, 176.4 kHz, 192 kHz
WAV (16 bit/24 bit)	32 kHz, 44.1 kHz, 48 kHz, 88.2 kHz, 96 kHz, 176.4 kHz, 192 kHz

- Number of playable files: Up to 2,000
- Maximum number of directories: Up to 200
- This product cannot play files protected by DRM (Digital Rights Management).
- This product cannot play video files from a USB storage device.

Mounting the Product to a Wall

Checking before mounting to a wall

You can mount this product onto a wall.

When mounting the product to the wall, follow the instructions below.

Please check the following first.

- It may be difficult to connect external devices and cables after wall-mounting. First, connect an external device with the proper connection cable to the product before mounting it to the wall.
- Please note the following when you mount the product to the wall. Product damage or injury may occur during the process.
 - Do not put objects on top of the wall-mounted product.
 - Secure the product firmly to the wall using the fixing screws so that it does not fall off.
 - Ensure it is out of the reach of children. Pulling or shaking the mounted product may cause it to fall.
- When assembling, ensure that all of the provided screws are attached. If the screws are not fully tightened, the product may tilt or tip over, resulting in damage. Tightening the screws with excessive force may cause them to come off due to abrasion of the screw joint.

Components for mounting the product

Soundbar



Wall bracket



Soundbar screws



Wall bracket installation guide



Sold separately

Bracket screws



Wall plugs



✔ Note

- Screws and Wall Plugs are not supplied for mounting the product. We recommend the Hilti (HUD-1 6 x 30) for the mounting.
-

Mounting the Product to a Wall

- 1 Find the wall bracket installation guide in the product package.
- 2 Align the **“TV Bottom Line”** on the wall bracket installation guide with the bottom of the TV, and attach it to the wall. Align the center of the wall-mounted TV with the part marked **“TV Center”** in the installation guide.

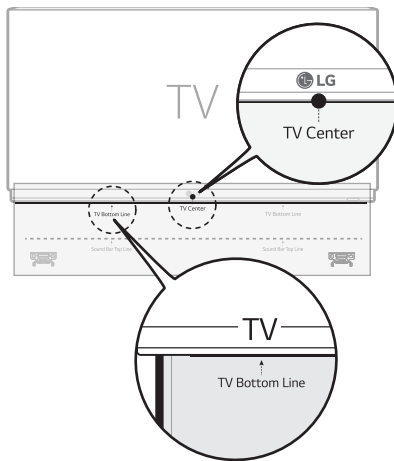

- 3 With a pen, mark screw holes on the installation guide where the wall brackets will be attached.

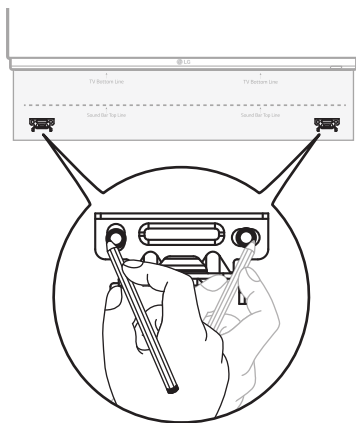

- 4 Drill screw holes in the marked positions on the installation guide.
- 5 Remove the wall bracket installation guide from the wall.

- 6** Fix the brackets firmly to the wall using the wall plugs and screws.

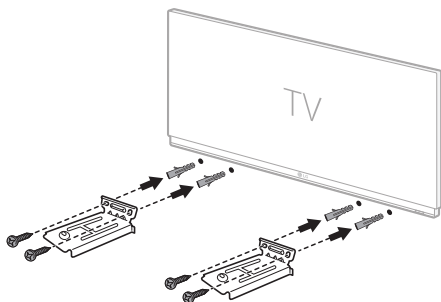

- 7** Place the product on the brackets. Position the product on the brackets so the screw holes on the bottom of the product align with the screw holes on the wall bracket.

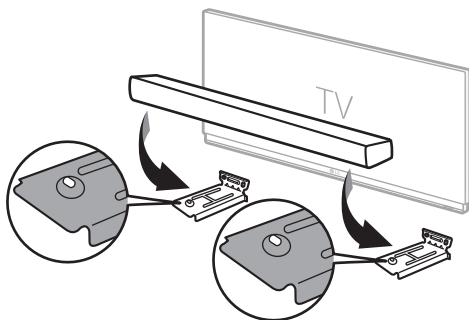

- 8** Firmly attach the product to the wall brackets using the screws provided.

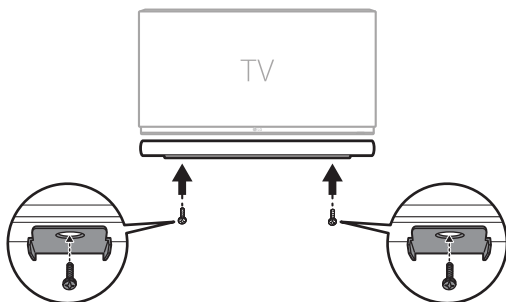

Safety Precautions

| Safety and Regulatory



CAUTION: TO REDUCE THE RISK OF ELECTRIC SHOCK DO NOT REMOVE COVER (OR BACK). NO USER-SERVICEABLE PARTS INSIDE. REFER SERVICING TO QUALIFIED SERVICE PERSONNEL.



This lightning flash with arrowhead symbol within an equilateral triangle is intended to alert the user to the presence of uninsulated dangerous voltage within the product's enclosure that may be of sufficient magnitude to constitute a risk of electric shock to persons.



The exclamation point within an equilateral triangle is intended to alert the user to the presence of important operating and maintenance (servicing) instructions in the literature accompanying the product.

WARNING:

- TO PREVENT FIRE OR ELECTRIC SHOCK HAZARD, DO NOT EXPOSE THIS PRODUCT TO RAIN OR MOISTURE.
- Do not install this equipment in a confined space such as a book case or similar unit.

CAUTION:

- Do not use high voltage products around this product. (ex. Electrical swatter) This product may malfunction due to electrical shock.
- No naked flame sources, such as lighted candles, should be placed on the apparatus.
- Do not block any ventilation openings. Install in accordance with the manufacturer's instructions. Slots and openings in the cabinet are provided for ventilation and to ensure reliable operation of the product and to protect it from over heating. The openings should never be blocked by placing the product on a bed, sofa, rug or other similar surface. This product shall not be placed in a built-in installation such as a bookcase or rack unless proper ventilation is provided or the manufacturer's instruction has been adhered to.
- The apparatus should not be exposed to water (dripping or splashing) and no objects filled with liquids, such as vases, should be placed on the apparatus.
- For safety marking information including product identification and supply ratings, please refer to the main label on the bottom or the other surface of the product.
- Be careful to make sure children do not put their hands or any objects into the *speaker duct.
 - * speaker duct: A hole for plentiful bass sound on speaker cabinet. (enclosure)

CAUTION concerning the Power Cord

Install this apparatus in a location where the power plug can be easily unplugged and plugged in. If there is a fire or problem with this apparatus, unplug it quickly.

Check the specification page of this owner's manual to be certain of the current requirements.

Do not overload wall outlets. Overloaded wall outlets, loose or damaged wall outlets, extension cords, frayed power cords, or damaged or cracked wire insulation are dangerous. Any of these conditions could result in electric shock or fire. Periodically examine the cord of your device, and if its appearance indicates damage or deterioration, unplug it, discontinue use of the device, and have the cord replaced with an exact replacement part by an authorized service center.

Protect the power cord from physical or mechanical abuse, such as being twisted, kinked, pinched, closed in a door, or walked upon. Pay particular attention to plugs, wall outlets, and the point where the cord exits the device.

For models using an adapter

Only use the AC adapter supplied with this device. Do not use a power supply from another device or another manufacturer. Using any other power cable or power supply may cause damage to the device. The LG limited warranty does not cover damage caused by the use of third party accessories.

For models using a battery

This device is equipped with a portable battery or accumulator.

CAUTION: Risk of fire or explosion if the battery is replaced by an incorrect type.

For models using a built-in battery

Do not store or transport at pressures lower than 11.6 kPa (0.116 bar) and at above 15,000 m (9.32 miles) altitude.

- replacement of a battery with an incorrect type that can defeat a safeguard (for example, in the case of some lithium battery types);
- disposal of a battery into fire or a hot oven, or mechanically crushing or cutting of a battery, that can result in an explosion;
- leaving a battery in an extremely high temperature surrounding environment that can result in an explosion or the leakage of flammable liquid or gas;
- a battery subjected to extremely low air pressure that may result in an explosion or the leakage of flammable liquid or gas.

Symbols

~ : Alternating current (AC).

≡ : Direct current (DC).

⊞ : This is a class II equipment.

⏻ : Standby power state.

⏻ : The power is turned on.

⚡ : Danger voltage.

Prevention of product misuse

To prevent misuse of the product, please be sure to check the contents below.

Precautions for installing the product

- Do not install the product in an unstable or vibrating place, such as on a shaking shelf or inclined surface. Install the product on a firm and level surface.
 - Otherwise, the product may fall or tip over and cause injury.
 - If you install the product on an unstable surface, the product may not work properly.
- If you install the product on a piece of furniture or shelf, make sure that the bottom front of the product does not protrude. Always use a piece of furniture or shelf that fits the product size.
 - Otherwise, the product may lose its balance and fall, causing injury or product damage.
- Install the product in a safe place. Otherwise, a child may bump into an edge of the product and get injured.
- Install the product in a place free from electromagnetic interference for proper operation.
- If you install the product in a place that does not meet the general use conditions, an unexpected quality problem may arise. So, make sure that you contact the service center first before installing the product in such a place.
- Do not keep the product in a place where the temperature is too high (above 40 °C (104 °F)) or too low (below 5 °C (41 °F)) or a place with too much humidity.
- Avoid places exposed to direct sunlight or heat, e.g., near a heater. Do not use or keep flammable sprays or substances near the product.
 - Otherwise, there is a risk of explosion or fire.
- Do not install the product in a place with too much moisture, dust or soot.
 - Otherwise, it may cause a fire or electric shock.
- Do not install the product in a narrow space, such as inside a bookshelf, that does not ventilate well. Do not cover the product with a table cover or curtain.
 - Otherwise, it may increase the product temperature, causing a breakdown or fire.
- Connect the power plug of the product to a power outlet that is easily accessible.
 - When a fire or other problem occurs in the product, you must be able to remove the power plug quickly.
- Do not connect multiple products to one power outlet at the same time.
 - Otherwise, it may cause overheating, resulting in a fire.

Precautions for using the product

- Do not lift or move the product while it is operating.
 - Otherwise, it may cause a breakdown.
- When moving the product, pull out the power cord and all cables connected to the product.
 - Otherwise, it may cause a fire or electric shock.
- Stop using the product immediately if you notice smoke or a strange odor. In this case, turn off the power immediately, disconnect the power plug, and contact the service center.
 - Using the product in this state may result in a fire or electric shock.
- Do not insert metal objects such as coins and hairpins or flammable objects such as paper and matchsticks into the product. Make sure that you tell any children not to do so.
 - Otherwise, it may cause a breakdown.
- If a foreign substance is inserted into the product, disconnect the power plug and contact the service center.
- Do not put a heavy object on top of the product.
 - Otherwise, it may tip over or fall, causing injury.
- Make sure that a child does not hang on the product or get on it.
 - Otherwise, the product may tip over or fall, causing injury. Make sure that you tell any children not to do so.
- Remove the power plug during thunderstorms.
 - Otherwise, it may cause a fire.
- Do not place vessels with liquid, such as a vase, pot, cosmetics, or medicine, on top of the product.
 - Otherwise, it may result in a fire, electric shock, or injury due to its fall, etc.
- Make sure that you connect the power plug firmly. Do not use voltage other than the rated voltage indicated on the product.
 - An insecure connection may result in a fire.
- Do not insert a conductor, such as chopsticks, into the groove on the other side of the product while the power plug is connected to an outlet. Do not touch the power plug immediately after unplugging it from the outlet.
 - Otherwise, it may cause electric shock.
- Hold the power plug with dry hands.
 - Otherwise, it may cause electric shock.
- Do not move or push the product while holding a product cable such as a power cord.
 - The cable may get damaged and cause a breakdown or result in a fire or electric shock.
- When removing a cable plugged into the product, make sure that you hold the connector at the end of the cable. Do not hold the cable line.
 - Otherwise, it may result in an injury or the product may fall and cause a breakdown.
- Do not keep the product in a place exposed to heat, e.g., near a heater.
 - Otherwise, it may cause a fire or malfunction.
- Do not disassemble, repair, or modify the product.
 - Otherwise, it may cause a breakdown, resulting in a fire, electric shock, or injury.
- Keep plastic wraps out of reach of toddlers.
 - Otherwise, toddlers may choke on the plastic wraps.
- Do not drop an object on the product or make an impact on it. Keep the product away from places with severe vibrations or magnets.

- Do not damage, modify, bend, twist, or heat a power cord.
 - Otherwise, it can damage the power cord, resulting in a fire or electric shock.
- When you are not using the product for a prolonged period, such as when you are away from home, unplug the power cord from the power outlet.
 - If dust accumulates, it can cause heat, resulting in electric shock or fire due to a short circuit.
- Do not dispose of waste batteries together with regular waste. Dispose of them separately.
 - Otherwise, there is a risk of explosion or fire.
- Do not use high voltage products around this product. (ex. Electrical swatter)
 - This product may malfunction due to electrical shock.
- Do not touch the power plug immediately after unplugging it from the outlet.
 - Otherwise, it may cause electric shock.
- Connect the power plug to a grounded outlet or extension cord. (This does not apply to products without a ground.)
 - Otherwise, it may cause a breakdown or electric shock due to a short circuit.
- In the case of a product with a vent, keeping the product turned on for a prolonged period can result in the vent getting hot. Do not touch the vent when it is hot. The heat is not a fault of the product and does not cause any malfunction. So, you may use the product without worry.
- Do not damage the power cable, AC adapter, or power plug. Do not place a heavy object on top of the power cable or AC adapter.
 - Otherwise, it may cause a fire or electric shock.
- If dust, dirt, etc. is found on the power plug pins, an AC adapter, or a power outlet, wipe it completely.
 - Otherwise, it may cause a fire.
- In the case of a product with a power cord or AC adapter, use only genuine power cords and AC adapters provided by LG Electronics.
 - Otherwise, it may cause a fire or electric shock.
- If you are using headphones or earphones, do not turn on the volume too loudly or use them for a prolonged period. [This only applies to models that support headphones or earphones]
 - Otherwise, it may negatively affect your hearing ability.
- The software of this product can be updated with the **LG Soundbar app**. Do not turn off the power of the product while updating the software. Once the update is complete, the product power turns off automatically.
 - If you turn off the power of the product while the software is being updated, it may cause a product malfunction.

The following only applies to models with a remote control

- Do not let children use the remote control. Keep the remote control out of reach of toddlers.
- Do not let children put the remote control in their mouth. Make sure that children don't swallow the remote control cover or a battery. If a child swallowed one, consult a physician immediately.
- Beware that children may step on the remote control cover and get injured.
- Remove obstacles between the product and the remote control for the smooth operation of the remote control.

The following only applies to models that use optical discs

- Do not insert your hand into a disc drive or pull it out forcefully.
- Make sure that children do not insert their hands into the disc drive.

The following only applies to models that able to watch video

- Refrain from watching a 3D video if you didn't have enough sleep or after drinking alcohol.
 - Some 3D videos may surprise or excite people.
- If any of the following symptoms occur while watching a video, stop watching it immediately and take a rest.
 - If any of the symptoms continue, consult a physician. Vertigo, burning sensation of eyes or face, unconscious motion, spasm, clouded consciousness, confusion, disorientation, nausea.
- You may suffer a symptom such as a seizure when you watch a certain image in a video or game or a video with a certain pattern or flashing lights. If you or any of your relatives have a history of epilepsy or seizures, consult a physician before watching.
- When you watch a 3D video, remove objects that are fragile or can cause injury from your surroundings.
 - If you mistake a 3D video as real or move your body with surprise, you or your nearby relatives may get injured or objects near you may get damaged.

Precautions for cleaning the product





- Do not spray water directly onto the product when cleaning it.
 - Otherwise, it may cause a fire or electric shock.
- When cleaning the product, make sure that you pull out the power cord first and wipe the surface of the product lightly with a dry cloth. Do not use chemicals or detergents when cleaning the product. They may deteriorate the product surface or peel off the paint from the product (benzene, alcohol, etc.).

Before Reporting Product Malfunction



Troubleshooting

If you experience the following issues while using the product, please perform several checks, as they may not be malfunctions.

General Errors

Issue	Solution
The product does not work properly	<ul style="list-style-type: none">• Unplug the power cables and any external devices such as your TV, subwoofer, or amplifier from the product, then plug them in again.
The power does not turn on	<ul style="list-style-type: none">• Is the power cord plugged into the outlet properly?<ul style="list-style-type: none">- Connect the power plug to the outlet correctly.
There is no sound	<ul style="list-style-type: none">• Is the volume set to minimum?<ul style="list-style-type: none">- Press the Volume   button on the remote control to turn up the volume.- If you are using an external device such as a set-top box, portable device, or Bluetooth device, adjust the volume of the external device.• Is the mute function activated?<ul style="list-style-type: none">- If all LEDs blink orange, the mute function is on. Press the Mute  button to unmute.• Is the correct product function selected according to the external device connected?<ul style="list-style-type: none">- Press the Function  button to check if you selected the correct function.
The subwoofer does not produce sound	<ul style="list-style-type: none">• Is the product properly connected to the wireless subwoofer?<ul style="list-style-type: none">- If the LED on the wireless subwoofer is blinking green or lit in red, it means it is not connected. If the connection is established, a green light will appear. Reconnect the product to the wireless subwoofer. (→ See “Connecting the Product” on page 6.)
The remote control does not work properly	<ul style="list-style-type: none">• When using the remote control, point it at the front of the product.• Use the remote control within a 7-m (23 ft) radius of the product.• Replace the batteries with new ones as needed.
The Auto Power function does not work	<ul style="list-style-type: none">• Check connection to external devices (ex. set-top box, portable device, Bluetooth device).
LG Sound Sync does not work	<ul style="list-style-type: none">• Check whether your TV supports LG Sound Sync.• Check if the TV is properly connected to the product via an optical cable.<ul style="list-style-type: none">- Press the Settings button on the TV remote control to check if the function is turned on in [LG Sound Sync].

The product volume is low

- Check the following and change the settings accordingly.
 - Run the **LG Soundbar app**, tap the **Settings**  button on the first screen, and change the [DRC] function to [Off] on the [Sound Settings] menu.
 - When the product is connected to a TV, press the **Settings** button on the TV remote control, select the [Speaker] menu, and change the [Digital Sound Output] setting from [PCM] to [AUTO] or [BITSTREAM].
 - If the product is connected to a playback device such as a DVD player or Blu-ray disc player, go to the connected device's Settings menu. Change the [Digital Sound Output] setting from [PCM] to [PRIMARY PASS-THROUGH] or [BITSTREAM]. Set the [DRC] of the connected device to [OFF].
 - If the product's Night Time mode is on, turn it off by pressing the **Settings**  button and **Left/Right** and then **Up/Down**.

The product fails to recognize a USB storage device

- The product may not support the file format of the USB storage device. Format the USB storage device and reconnect it. When formatting, refer to the USB storage device formats supported by the product and select an appropriate file format. (→ See "Connecting to a USB Storage Device" on page 43.)



A Bluetooth device cannot be paired

- Press the Settings button on the **Bluetooth** device and check whether the **Bluetooth** function is enabled. If **Bluetooth** is enabled, turn it off and on, then try again.
 - Remove any obstacles between the product and the **Bluetooth** device.
 - **Bluetooth** pairing (connection) may not work properly depending on the **Bluetooth** device type or the surrounding environment.
-

Problems in Wireless Connection

Issue	Solution
There is radio interference	<ul style="list-style-type: none">• Install the product and the wireless subwoofer as close to each other as possible.• Do not install the product on metal furniture.• Wireless communication may not work properly in weak signal areas.
The Bluetooth connection is causing a malfunction or making noise	<ul style="list-style-type: none">• Do you hear noise or experience malfunctions when using Bluetooth?<ul style="list-style-type: none">- Do not let any part of your body contact the transceiver of the Bluetooth device or the product.- Do not install the Bluetooth device on a wall or in a secluded spot.- Remove any obstacles between the product and the Bluetooth device.- Install the Bluetooth device near the product.• When the Bluetooth device is too far from the product, Bluetooth may be disconnected or malfunctions may occur.<ul style="list-style-type: none">- Install the Bluetooth device 1 m (3.3 ft) away from devices that use the same frequency as the product, such as wireless routers, medical equipment, and microwave ovens.

Turning off the Demo Mode

Issue	Solution
The remote control does not work	<ul style="list-style-type: none">• Does the functions unchanged, even if you press the Function  button several times?• Do you only see white, red, and green LEDs repeatedly?<ul style="list-style-type: none">- The demo mode may be activated on the product. Unplug the product's power cable and plug it back in.- If the remote control still does not work, press and hold the Function  button on the soundbar for about 5 seconds. If the product works normally, it means that the demo mode has been turned off.

Appendix

Specifications

General	
Power requirements	Refer to the main label.
Power Consumption	Refer to the main label.
Dimensions (W x H x D)	Approx. 850.0 mm x 63.0 mm x 87.0 mm (including the base) (33.4 inch x 2.5 inch x 3.4 inch)
Operation Temperature Range	5 °C - 40 °C (41 °F to 104 °F)
Operation Humidity Range	5 % - 80 % RH
Bus Power Supply (USB)	5 V  500 mA
Available Digital Input Audio Sampling Frequency	32 kHz, 44.1 kHz, 48 kHz, 88.2 kHz, 96 kHz
Available Digital Input Audio format	Dolby Digital, DTS Digital Surround, PCM

Input/Output	
OPTICAL IN	3.0 V (p-p), (optical audio connection terminal) × 1
HDMI™ ► TV (ARC)	19-pin (Type A, HDMI™ connection terminal) × 1

Amplifier (RMS output)	
Total	440 W RMS
Front	40 W RMS × 2 (Impedance: 4 Ω, THD 10 %)
Center	40 W RMS (Impedance: 4 Ω, THD 10 %)
Rear	50 W RMS × 2 (Impedance: 4 Ω, THD 10 %)
Subwoofer	220 W RMS (Impedance: 3 Ω, THD 10 %)

Wireless Subwoofer	
Power Requirement	Refer to the main label on the Wireless Subwoofer.
Power Consumption	Refer to the main label on the Wireless Subwoofer.
Type	1-way 1 speaker
Impedance	3 Ω
Rated power	220 W RMS
Max Power	440 W RMS
Dimensions (W x H x D)	Approx. 200.0 mm x 377.0 mm x 285.0 mm (including the base) (7.9 inch x 14.8 inch x 11.2 inch)

Rear Speakers (SPT8-S)

Wireless Receiver (Included in the Rear Speaker)	
Power Requirement	Refer to the main label on the wireless receiver.
Power Consumption	Refer to the main label on the wireless receiver.
Rear Power	50 W RMS x 2 (Impedance: 4 Ω , THD 10 %)
Operation Temperature Range	5 $^{\circ}\text{C}$ - 40 $^{\circ}\text{C}$ (41 $^{\circ}\text{F}$ to 104 $^{\circ}\text{F}$)
Operation Humidity Range	5 % - 80 % RH

Rear Speakers (Each)	
Type	1-way 1 speaker
Impedance	4 Ω
Rated power	50 W RMS
Max. Power	100 W RMS
Dimensions (W x H x D)	Approx. 100.0 mm x 176.5 mm x 120.0 mm (including the base) (3.9 inch x 6.9 inch x 4.7 inch)

- Actual features, functionality, and other product specifications may differ and are subject to change without notice.

| Registered Trademarks and Licenses

All trademarks and trade names are the property of their respective owners.



Dolby, Dolby Audio and the double-D symbol are trademarks of Dolby Laboratories Licensing Corporation. Manufactured under license from Dolby Laboratories. Confidential unpublished works. Copyright © 2012–2021 Dolby Laboratories. All rights reserved.



The **Bluetooth**® word mark and logos are registered trademarks owned by the **Bluetooth** SIG, Inc. and any use of such marks by LG Electronics is under license.

Other trademarks and trade names are those of their respective owners.



The terms HDMI, HDMI High-Definition Multimedia Interface, HDMI Trade Dress and the HDMI Logos are trademarks or registered trademarks of HDMI Licensing Administrator, Inc.



"Made for iPhone," and "Made for iPod" mean that an electronic accessory has been designed to connect specifically to iPhone, or iPod, respectively, and has been certified by the developer to meet Apple performance standards. Apple is not responsible for the operation of this device or its compliance with safety and regulatory standards. Please note that the use of this accessory with iPhone or iPod may affect wireless performance.





For DTS patents, see <http://patents.dts.com>. Manufactured under license from DTS, Inc. or DTS Licensing Limited. DTS, Digital Surround, and the DTS logo are registered trademarks or trademarks of DTS, Inc. in the United States and other countries. © 2021 DTS, Inc. ALL RIGHTS RESERVED.

| Open Source Software Notice Information

To obtain the source code that is contained in this product, under GPL, LGPL, MPL, and other open source licenses that have the obligation to disclose source code, and to access all referred license terms, copyright notices and other relevant documents, please visit <https://opensource.lge.com>.

LG Electronics will also provide open source code to you on CD-ROM for a charge covering the cost of performing such distribution (such as the cost of media, shipping, and handling) upon email request to opensource@lge.com.

This offer is valid to anyone in receipt of this information for a period of three years after our last shipment of this product.

| Handling the Product

When shipping the Product

Please save the original shipping carton and packing materials. If you need to ship the product, for maximum protection, re-pack the product as it was originally packed at the factory.

Keeping the exterior surfaces clean

- Do not use volatile liquids such as insecticide spray near the product.
- Wiping with strong pressure may damage the surface.
- Do not leave rubber or plastic products in contact with the product for a long period of time.

Cleaning the product

To clean the product, use a soft, dry cloth. If the surfaces are extremely dirty, use a soft cloth lightly moistened with a mild detergent solution. Do not use strong solvents such as alcohol, benzine, or thinner, as these might damage the surface of the product.

