

X3-17-SW-P
CAN-AM® MAVERICK X3 PASSENGER SUBWOOFER ENCLOSURE
OWNER'S MANUAL



THANK YOU

Thank you for making the AWESOME decision to purchase our MTX Audio direct-fit subwoofer enclosure designed for the Can-Am® Maverick X3. Our sub enclosure, with its 3512-04S 12" shallow subwoofer, will belt out the bass and deliver ground pounding audio making you the party vehicle in any ride! With a few basic hand tools in your trusty toolbox, you can have this installed in no time. So, what are you waiting for? It's time to get the rumble in your ride and go hit the trails! Oh, and congratulations on your purchase, thanks for your support and most importantly, enjoy the ultimate audio experience with MTX!

WE'RE HERE TO HELP

We're here to help with any installation or technical support. Visit mtx.com to chat, call 1-800-225-5689 to speak with an MTX Technical Support representative, or visit youtube.com/user/MTXAudioUSA to view product videos.

DON'T FORGET TO REGISTER YOUR PRODUCT

Don't forget to register your new MTX Audio product. Visit mtx.com/productregistration or scan the QR code to the right.

Model # _____

Serial # _____

Dealer's Name _____

Date of Purchase _____



IMPORTANT NOTICE

Whenever working on the vehicle, it is recommended to disconnect the battery prior to starting work. Failure to do so may lead to a risk of electric shock or equipment damage.

When connecting power and ground wires ensure that the red power wire is fused at the point where it is connected to the vehicle's battery. Failure to do so can result in damage to the vehicle if a short circuit develops between the vehicle connection point and the product.



FEATURES

- Includes an MTX 3512-04S 12" Shallow Subwoofer
- Mounts Under Passenger Seat
- Factory Matched Texture
- Installer Friendly Design
- Direct Fit, No Cutting or Drilling Required

SPECIFICATIONS

- 12" Loaded Subwoofer Enclosure
- RMS Power Handling: 300-Watts
- Peak Power Handling: 600-Watts
- Sensitivity (2.83V/1m): 88.5dB
- Sensitivity (1W/1m): 84.4dB
- Frequency Response: 23Hz - 130Hz
- Impedance: 4Ω

FIT GUIDE

Turbo / Max Turbo.....	2018 - 2019
Turbo R / Max Turbo R.....	2017 - 2019
X-DS Turbo	2017
X-RS Turbo R / Max X-RS Turbo R.....	2017 - 2019
X-DS Turbo R / Max X-DS Turbo R	2018 - 2019
X-MR Turbo	2019 - 2021
X-MR Turbo R.....	2019
X-RC Turbo	2019 - 2021
X-MC Turbo R.....	2019
DS Turbo / Max DS Turbo	2020 - 2021
RS Turbo	2020
DS Turbo R / Max DS Turbo R	2020 - 2021
Max DS Turbo RR	2020
RS Turbo R / Max RS Turbo R.....	2020 - 2021
X-RC Turbo RR	2020 - 2021
X-RS Turbo RR / Max X-RS Turbo RR.....	2020 - 2021
X-MR Turbo RR / Max X-MR Turbo RR	2020 - 2021
X-MS Turbo RR	2020
X-DS Turbo RR / Max X-DS Turbo RR	2020 - 2021

FIT GUIDE NOTES

Only the X3-17-SW-D driver side enclosure includes the signal harness from the amp.

IN THE BOX

- X3-17-SW-P Loaded Subwoofer Enclosure
- Adhesive Foam Tape
- Mounting Hardware
 - (1) Mounting Bracket
 - (5) T40 Torx Bolts

INSTALLATION

Step 1 - Release the lower seat belt strap from the harness by feeding it back through the tension assembly. This will allow you to feed the shoulder straps through the holes at the top of the seat.



Step 2 - Remove two (2) 13mm bolts and nuts at the front of the seat frame.



Step 3 - Access the rear 18mm nuts using a socket with extension either by aligning the holes in the seat base over the nuts or by sliding the seat fully forward and reaching behind.



Step 4 - With the seat free, lift the seat out of the vehicle and set aside.

Step 5 - Remove the 10mm M6 bolt holding the brake line clamp in place on the seat frame.

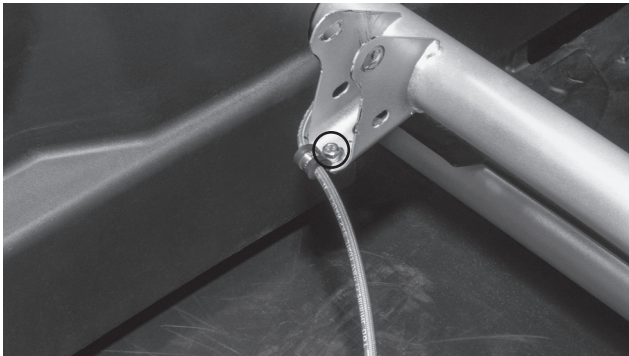

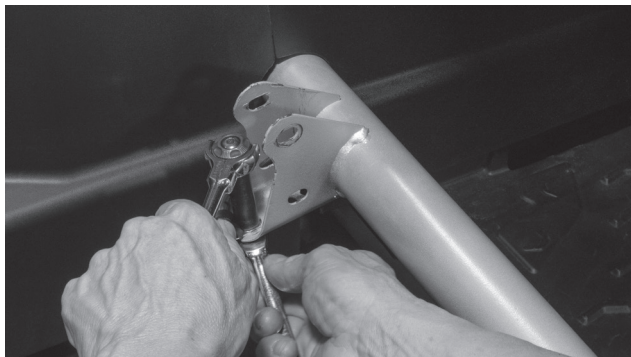

Step 6 - Remove the cable clamp from the brake line.

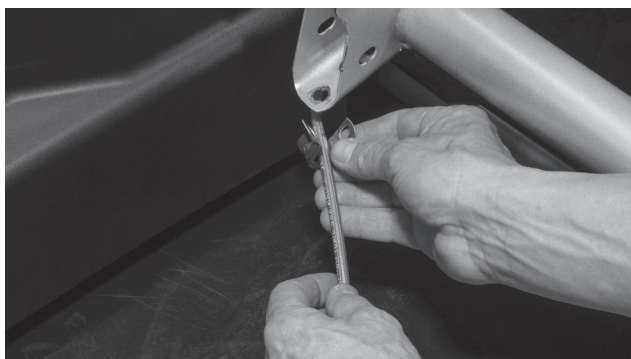

Step 7 - Wrap the brake line with the strip of adhesive backed foam tape included in the box. **Note:** This step is to prevent the brake line from rattling against the enclosure under high bass output and any chaffing due to movement of the brake line while the vehicle is in motion.



Step 8 - Tilt the front of the enclosure down and slide it under the forward crossbar as you set it in place onto the floor of the vehicle tucking the brake line into the pre-molded slot in the bottom of the enclosure.

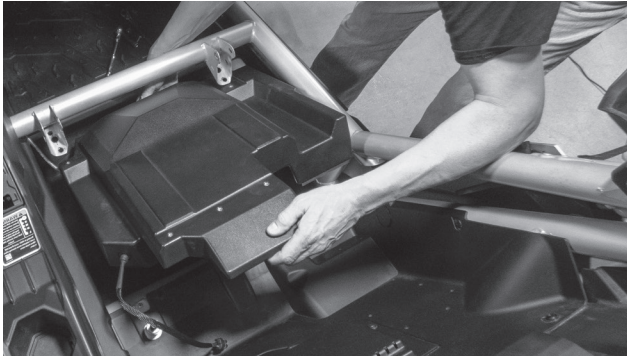

Step 9 - Taking the long bar bracket included, align the slotted holes with the threaded insets on the top rear of the enclosure. The two large holes at either end should slide over the threaded seat mounting posts.

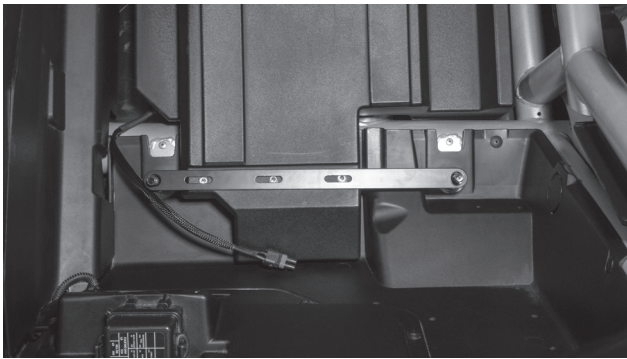

Step 10 - Loosely install three (3) T-40 Torx screws into the bracket.



Step 11 - Align the threaded inserts at the front corners of the enclosure with the holes in the bottom of the seat brackets and insert two (2) T-40 Torx screws.

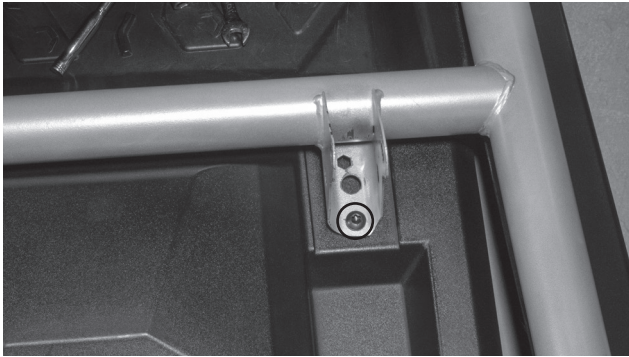
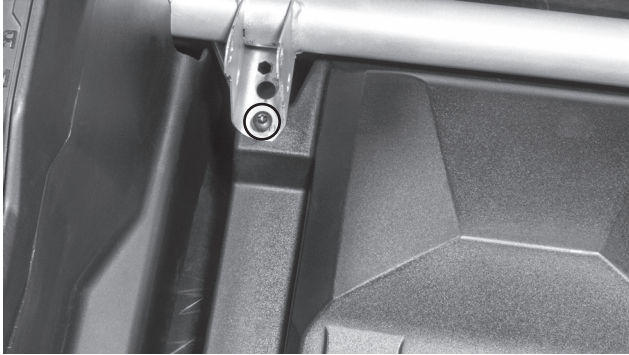

Step 12 - Once all fasteners are in place, tighten to secure the enclosure.

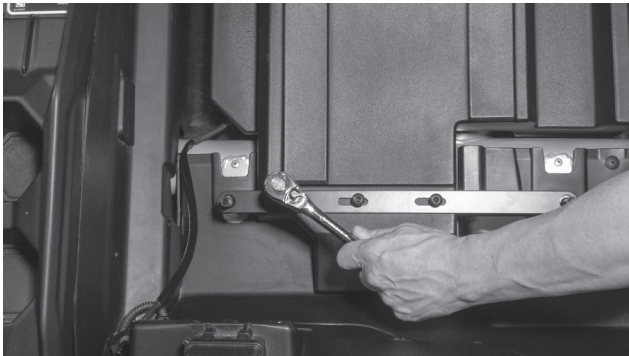

Step 13 - Route the subwoofer cable to the desired connection point. **Note:** If installing as part of a kit, the subwoofer plug will connect to the main harness supplied. If not installing as part of a kit, the plug will need to be removed and additional speaker wire added.

Step 14 - With your wire routed and system tested, reinstall the seat in the reverse order as removed. **Note:** In the event of floor pan rattle, included in the subwoofer kit are a self-tapping drill bit and bolts to allow you to bolt the floor pan directly to the frame of the vehicle. Please refer to the installation videos for more information on their use at www.youtube.com/user/MTXAudioUSA

Step 15 - Reassemble and go ride.

NOTES

WARRANTY PERIOD

At MTX Audio we engineer products that will stand up to the test of time. We also realize that from time to time a problem may occur. That's why our products carry a 2-year limited warranty that begins at the time of sale to the end user.

Of course, we're here to help. If you experience an issue with any of our products within the warranty period, please contact our customer service technical line at 1-800-CALL-MTX to help troubleshoot your issue. If, after speaking with our technical experts it is determined that a problem lies with the product, the technician will provide you with a Return Authorization number and all relevant details you'll need to get the product taken care of.

MITEK WARRANTY

MiTek Mobile products (including, but not limited to: MTX, Coustic, Streetwires, Xtant, BassSlammer, and Thunder Marine) purchased in the USA from an AUTHORIZED MITEK DEALER are guaranteed against defects in material and workmanship for the period of time specified. The warranty period begins the day the product is purchased by the end user, and this warranty is limited to the original retail purchaser of product. Products found to be defective during the warranty period will be repaired or replaced with equivalent product by MiTek at no charge. This warranty is void if it is determined that unauthorized parties have attempted repairs or alterations of any nature, and the warranty does not extend to cosmetics or finish. MiTek disclaims any liability for other incurred or consequential damages resulting from product defects. MiTek's total liability will not exceed the purchase price of the product.



Let's Get Social
mtx.com



Like, Follow, & Subscribe

© 2021 MiTek Corporation. All rights reserved. MTX is a trademark of MiTek Corporation. All other trademarks are property of their respective owners. Designed and Engineered in the U.S.A.

Due to continual product development, all specifications are subject to change without notice.

MTX Audio, 4545 East Baseline Rd. Phoenix, AZ 85042 U.S.A. 1-800-225-5689

MTX006228 RevA 1/21 • 21A10813 • AW0015868