

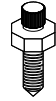

A1



A2×8



A3×8



M6×20
A4×12

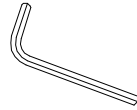

A5



A6×8

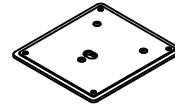

B1×2

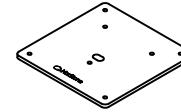

B2×2

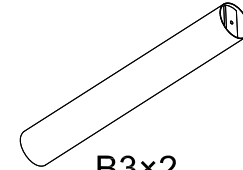

B3×2

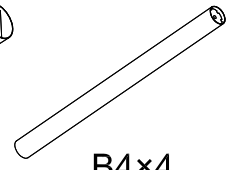

B4×4

1

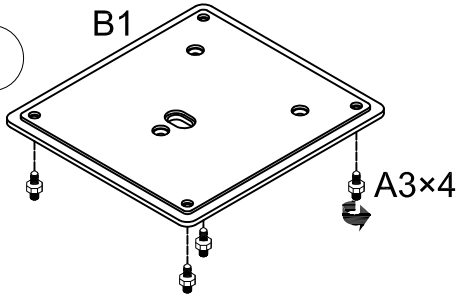

2

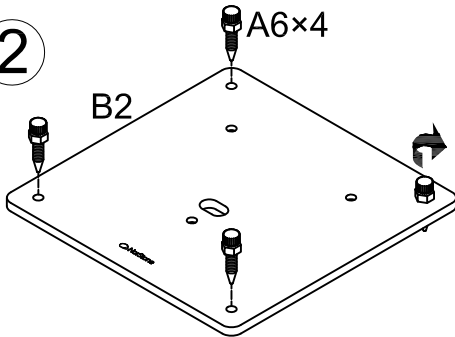

3

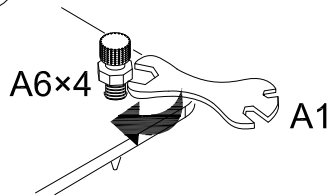

4

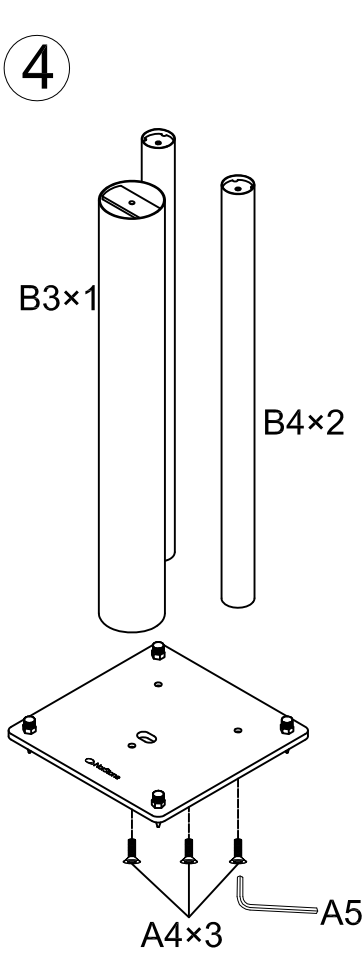

5

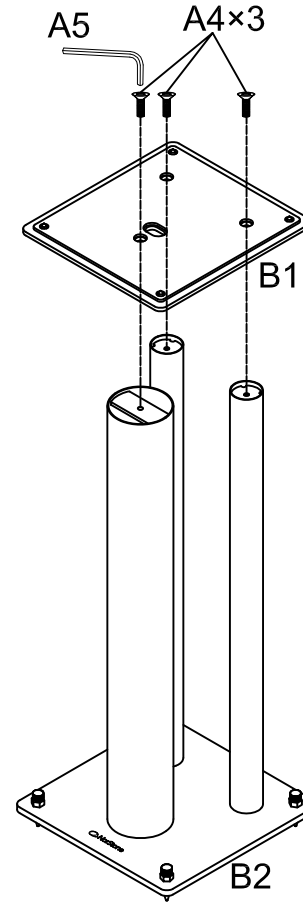

6

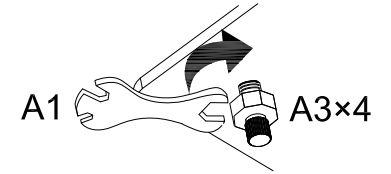

7

