

Pioneer

DMH-W2770NEX

DMH-W2700NEX

RDS AV RECEIVER

English



Operation Manual



Important (Serial number)

The serial number is located on the bottom of this unit. For your own security and convenience, be sure to record this number on the enclosed warranty card.

Contents

Thank you for buying this Pioneer product.
Please read through these instructions so you will know how to operate your model properly. After you have finished reading the instructions, keep this document in a safe place for future reference.

Important

The screen shown in the examples may differ from actual screens, which may be changed without notice for performance and function improvements.

■ Precaution	4
■ Parts and controls	9
■ Basic operation	11
■ Bluetooth®	14
■ Wi-Fi®	20
■ AV source	21
■ Radio	22
■ Compressed files	24
■ iPhone	28
■ WebLink™	30
■ USB Mirroring	32
■ Apple CarPlay	33
■ Android Auto™	36
■ SiriusXM® Satellite Radio	39
■ AUX	42
■ Camera View	43
■ Settings	44
Displaying the setting screen	44
System Settings	44
Display Settings	46
Audio & EQ Settings	47

Camera settings	48
Phone Connectivity Settings.....	51
■ Other functions	52
■ Appendix	53

Precaution

Important safety information

WARNING

- Do not attempt to install or service this product by yourself. Installation or servicing of this product by persons without training and experience in electronic equipment and automotive accessories may be dangerous and could expose you to the risk of electric shock, injury or other hazards.
- Do not allow this product to come into contact with liquids. Electrical shock could result. Also, damage to the product, smoke, and overheating could result from contact with liquids.
- If liquid or foreign matter should get inside this product, park your vehicle in a safe place, turn the ignition switch off (ACC OFF) immediately and consult your dealer or the nearest authorized Pioneer Service Station. Do not use this product in this condition because doing so may result in a fire, electric shock, or other failure.
- If you notice smoke, a strange noise or odor from this product, or any other abnormal signs on the LCD screen, turn off the power immediately and consult your dealer or the nearest authorized Pioneer Service Station. Using this product in this condition may result in permanent damage to the system.
- Do not disassemble or modify this product, as there are high-voltage components inside which may cause an electric shock. Be sure to consult your dealer or the nearest authorized Pioneer Service Station for internal inspection, adjustments or repairs.

Before using this product, be sure to read and fully understand the following safety information:

- Do not operate this product, any applications, or the rear view camera option (if purchased) if doing so will divert your attention in any way from the safe operation of your vehicle. Always observe safe driving rules and follow all existing traffic regulations. If you experience difficulty in operating this product, pull over, park your vehicle in a safe location and apply the parking brake before making the necessary adjustments.
- Never set the volume of this product so high that you cannot hear outside traffic and emergency vehicles.
- To promote safety, certain functions are disabled unless the vehicle is stopped and the parking brake is applied.
- Keep this manual handy as a reference for operating procedures and safety information.
- Do not install this product where it may (i) obstruct the driver's vision, (ii) impair the performance of any of the vehicle's operating systems or safety features, including air bags or hazard lamp buttons or (iii) impair the driver's ability to safely operate the vehicle.
- Please remember to fasten your seat belt at all times while operating your vehicle. If you are ever in an accident, your injuries can be considerably more severe if your seat belt is not properly buckled.
- Never use headphones while driving.

- Rear visibility systems (backup cameras) are required in certain new vehicles sold in the U.S. and Canada. U.S. regulations began according to a two year phase-in on May 1, 2016, and both the U.S. and Canada require that all such vehicles manufactured on or after May 1, 2018 have rear visibility systems. **Owners of vehicles equipped with compliant rear visibility systems should not install or use this product in a way that alters or disables that system's compliance with applicable regulations.** If you are unsure whether your vehicle has a rear visibility system subject to the U.S. or Canadian regulations, please contact the vehicle manufacturer or dealer.

If your vehicle has a compliant backup camera that displays the backup view through the factory receiver, do not use the Pioneer receiver unless it is connected to and displays the same view as the factory backup camera. Connection to the factory backup camera will require an adaptor, sold separately. Not all vehicles may be able to connect. Please check with a qualified professional installer for installation options specific to your vehicle.

Parking brake interlock

Certain functions (such as viewing of video image and certain touch panel key operations) offered by this product could be dangerous (possibly resulting in serious injury or death) and/or unlawful if used while driving. To prevent such functions from being used while the vehicle is in motion, there is an interlock system that senses when the parking brake is set and when the vehicle is moving. If you attempt to use the functions described above while driving, they will become disabled until you stop the vehicle in a safe place, and (1) apply the parking brake, (2) release the parking brake, and then (3) apply the parking brake again. Please keep the brake pedal pushed down before releasing the parking brake.

To ensure safe driving

WARNING

- **LIGHT GREEN LEAD AT POWER CONNECTOR IS DESIGNED TO DETECT PARKED STATUS AND MUST BE CONNECTED TO THE POWER SUPPLY SIDE OF THE PARKING BRAKE SWITCH. IMPROPER CONNECTION OR USE OF THIS LEAD MAY VIOLATE APPLICABLE LAW AND MAY RESULT IN SERIOUS INJURY OR DAMAGE.**
 - **Do not take any steps to tamper with or disable the parking brake interlock system which is in place for your protection. Tampering with or disabling the parking brake interlock system could result in serious injury or death.**
 - **To avoid the risk of damage and injury and the potential violation of applicable laws, this product is not for use with a video image that is visible to the driver.**
 - In some countries the viewing of video image on a display inside a vehicle even by persons other than the driver may be illegal. Where such regulations apply, they must be obeyed.
- If you attempt to watch video image while driving, the warning **“Viewing of front seat video source while driving is strictly prohibited.”** will appear on the screen. To watch

video image on this display, stop the vehicle in a safe place and apply the parking brake. Please keep the brake pedal pushed down before releasing the parking brake.

When using a display connected to the video output terminal

The video output terminal is for connection of a display to enable passengers in the rear seats to watch video images.

WARNING

NEVER install the rear display in a location that enables the driver to watch video images while driving.

To avoid battery exhaustion

Be sure to run the vehicle engine while using this product. Using this product without running the engine can drain the battery.

WARNING

Do not install this product in a vehicle that does not have an ACC wire or circuitry available.

Rear view camera

With an optional rear view camera, you are able to use this product as an aid to keep an eye on trailers, or backing into a tight parking spot.

WARNING

- SCREEN IMAGE MAY APPEAR REVERSED.
- USE INPUT ONLY FOR REVERSE OR MIRROR IMAGE REAR VIEW CAMERA. OTHER USE MAY RESULT IN INJURY OR DAMAGE.

CAUTION

The rear view mode is to use this product as an aid to keep an eye on the trailers, or while backing up. Do not use this function for entertainment purposes.

Handling the USB connector

CAUTION

- To prevent data loss and damage to the storage device, never remove it from this product while data is being transferred.
- Pioneer cannot guarantee compatibility with all USB mass storage devices and assumes no responsibility for any loss of data on media players, iPhone, smartphone, or other devices while using this product.

- It may not be recognized properly by this product if a USB device that had been incorrectly disconnected from the computer is connected.

Failure to operate

After-sales service for Pioneer products

Please contact the dealer or distributor from which you purchased the product for after-sales service (including warranty conditions) or any other information. In case the necessary information is not available, please contact the companies listed below.

Please do not ship your product to the companies at the addresses listed below for repair without making advance contact.

–USA&CANADA

Pioneer Electronics (USA) Inc.

CUSTOMER SUPPORT DIVISION

P.O. Box 1760 Long Beach, CA 90801-1760, U.S.A

800-421-1404

For warranty information, please see the Limited Warranty sheet included with your product.

Visit our website

Visit us at the following site:

<https://www.pioneerelectronics.com/PUSA/>

<https://www.pioneerelectronics.ca/POCEN/>

- 1 Register your product.**
- 2 Receive updates on the latest products and technologies.**
- 3 Download owner's manuals, order product catalogs, research new products, and much more.**
- 4 Receive notices of software upgrades and software updates.**

Protecting the LCD panel and screen

- Do not expose the LCD screen to direct sunlight when this product is not used. This may result in LCD screen malfunction due to the resulting high temperatures.
- When using a cellular phone, keep the antenna of the cellular phone away from the LCD screen to prevent disruption of the video in the form of spots, colored stripes, etc.
- To protect the LCD screen from damage, be sure to touch the touch panel keys only with your finger and do so gently.



Notes on internal memory

- The information will be erased by disconnecting the yellow lead from the battery (or removing the battery itself).
- Some of the settings and recorded contents will not be reset.

About this manual

- This manual uses diagrams of actual screens to describe operations. However, the screens on some units may not match those shown in this manual depending on the model used.
- When an iPhone is connected to the unit, the source name on the unit appears as [iPod]. Please note that this unit only supports iPhone regardless of the source name. For details of iPhone compatibility, refer to Compatible iPhone models (page 63).



Meanings of symbols used in this manual

	This indicates model names that are supported by the described operations.
	This indicates to touch the appropriate soft key on the touch screen.
	This indicates to touch and hold the appropriate soft key on the touch screen.

Parts and controls

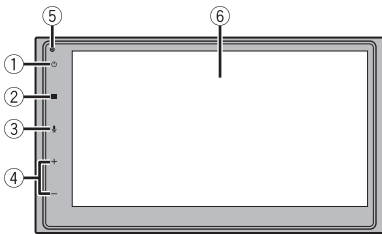
Main unit



①		<p>Touch to turn off the display information. To turn on the display information, touch again. Touch and hold to power off. To power back on, touch again.</p> <p>TIP If you power the unit off, you can turn off almost all functions. The unit turns on by operating the following functions:</p> <ul style="list-style-type: none"> • An incoming call is received (only for hands-free phoning via Bluetooth). • A rear view camera image is input when the vehicle is in reverse. • The ignition switch is turned off (ACC OFF), then turned on (ACC ON).
②		<p>Touch to display the top menu screen. Touch and hold to mute or unmute.</p>
③		<p>Touch to activate the voice recognition mode.*1 Touch and hold to display the mobile device search screen.*2</p>
④	VOL (+/-)	<p>Touch to adjust the volume.</p>
⑤	RESET	<p>Press to reset the microprocessor (page 11).</p>
⑥	LCD screen	

*1 This function is available only when Apple CarPlay or Android Auto is activated.

*2 This function is not available when Apple CarPlay or Android Auto is activated.

Remote control

W2770NEX

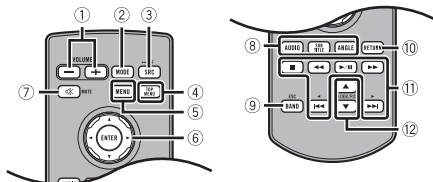

①	Volume (+/-)	
②	MODE	Not used.
③	SRC	Press to cycle through all the available sources. Press and hold to turn the power off.
④	TOP MENU	Not used.
⑤	MENU	Not used.
⑥	Thumb pad	Not used.
⑦	MUTE	
⑧	AUDIO SUBTITLE ANGLE	Not used.
⑨	BAND/ESC	Press to select the tuner band when tuner is selected as a source.
⑩	RETURN	Not used.
⑪	▶/	Press to pause or playback.
	◀◀ or ▶▶	Press to return to the previous track (chapter) or go to the next track (chapter). Press and hold to perform fast reverse or fast forward.
	◀◀ or ▶▶	Press to return to the previous track (chapter) or go to the next track (chapter).
	■	For USB audio: No action. For USB image: Press to stop playback. For USB video: Press to stop playback.
⑫	FOLDER/P.CH	Press to select the next or previous title or folder. Press to recall radio station frequencies assigned to preset channel keys. Press to answer or end a call (only for hands-free phoning via Bluetooth).

W2700NEX

The remote control is sold separately. For details concerning operations, see the remote control manual.

Basic operation

Resetting the microprocessor

CAUTION

- Pressing the RESET button restarts this product. In that case, some of the settings and recorded contents are reset to the factory settings.
 - Do not perform this operation when a device is connected to this product.
- The microprocessor must be reset under the following conditions:
 - Prior to using this product for the first time after installation.
 - If this product fails to operate properly.
 - If there appears to be problems with the operation of the system.

1 Turn the ignition switch OFF.

2 Press RESET with a pen tip or other pointed tools.

Settings and recorded contents are reset to the factory settings.

Using the touch panel

You can operate this product by touching the keys on the screen directly with your fingers.

NOTE

To protect the LCD screen from damage, be sure to touch the screen only with your finger gently.

Common touch panel keys

: Returns to the previous screen.

: Close the screen.

Operating list screens

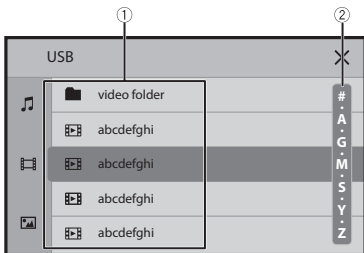

- ① **Touching an item on the list allows you to narrow down the options and proceed to the next operation.**
- ② **Appears when items cannot be displayed on a single page.**
Drag the side bar, the initial search bar or the list to view any hidden items.



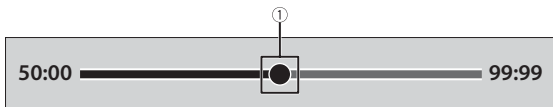





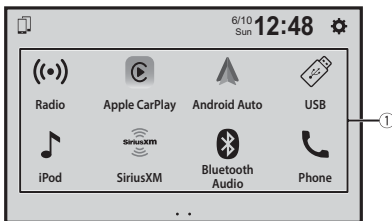



Operating the time bar



- ① **You can change the playback point by dragging the key.**



Top menu screen



①	<p>Source icons</p> <p>TIP You can display the hidden source icon(s) by swiping left on the screen.</p>
	<p>Setting the clock display (page 52)</p>
	<p>Settings (page 44)</p>
	<p>Displays the connected devices.</p> <p>: lights up when Apple CarPlay is available. : lights up when Android Auto is available. : lights up when hands-free phoning via Bluetooth is available. : lights up when Bluetooth audio is available.</p> <ul style="list-style-type: none"> • Touch the device name to switch the device to be connected with Apple CarPlay or Android Auto. • Touch  to light  and  up, when you use hands-free phoning or Bluetooth audio. • If there is no connected device, a message that prompts you to search the Bluetooth device will appear. Touch [Yes] to search the device. <p>NOTES</p> <ul style="list-style-type: none"> • You can search the device by touching  if you cannot find the device you want to connect. • You can delete the device by touching  if you cannot add the device because the number of registered devices are full.

Bluetooth®

Bluetooth connection

- 1 Turn on the Bluetooth function on the device.
- 2 Display the connected Bluetooth device list screen on the device.
- 3 Touch .
- 4 Touch .
- The device search screen appears.
- 5 Touch [Yes] to start searching.
Touch  if another device is already connected to the unit.
- 6 Touch a desired device on the screen.

NOTE

A pop-up message may appear if another device is already connected to the unit. Touch [OK] on the message.

- 7 Touch [Yes] to pair with the device.
- 8 Perform the pairing operation by operating the device.
After the device is successfully registered, a Bluetooth connection is established by the system. Once the connection is established, the device name is displayed on the list.

TIPS

- Once an Android Auto compatible smartphone is connected via Bluetooth, the smartphone may be automatically connected with Wireless Android Auto at the timing of Bluetooth reconnection such as by turning the ignition switch to on (ACC ON).
- The unit's screen changes to the hands-free phoning screen when you start the Siri function on your iPhone while the iPhone is connected to the unit via Bluetooth.

NOTES



- If five devices are already paired, the message confirming whether to delete the registered device is displayed. If you want to delete the device, touch [Agree]. If you want to delete other device, touch [Go To DeviceList] and delete the devices manually (page 13).
- If your device supports SSP (Secure Simple Pairing), a six-digit number appears on the display of this product. Touch [Yes] to pair the device.

Bluetooth Settings

- 1 Touch .
- 2 Touch  then [Bluetooth Settings].

CAUTION

Never turn this product off and disconnect the device while the Bluetooth setting operation is being processed.

Menu Item	Description
[Connection]	Activate to connect the last connected Bluetooth device automatically.
[Auto Answer]	(page 17)
[Search]	Search for available devices.
[Bluetooth Memory Clear]	Touch [OK] to clear the Bluetooth memory.
[Bluetooth Paired Device List]	Display the paired device list. Touch  to delete registered device. Touch  to activate/deactivate hands-free phoning or Bluetooth audio. TIP Perform the operations on the select device screen (page 13) to switch the device to be connected with Apple CarPlay or Android Auto.
[Bluetooth Device Info]	Displaying the device name of this product.



Hands-free phoning

To use this function you need to connect your cellular phone to this product via Bluetooth in advance (page 14).



CAUTION









For your safety, avoid talking on the phone as much as possible while driving.

Making a phone call

- 1 Touch .
- 2 Touch .
The phone menu screen appears.
- 3 Touch one of the call icons on the phone menu screen.

TIPS



-  on the top menu screen is not available while Android Auto is on. In that case, use the Android Auto phone function.
- Confirm whether hands-free phoning via Bluetooth is activated if  on the top menu screen is not available (page 13).

	<p>The following items are displayed.</p> <ul style="list-style-type: none"> • Reception status of the current cellular phone • Battery status of the current cellular phone
	<p>Synchronizes the contacts on this product's phone book with the contacts on your phone manually.</p>
	<p>Using phone book Select a contact from the phone book. Touch the desired name on the list then select the phone number.</p> <p>TIPS</p> <ul style="list-style-type: none"> • The contacts on your phone will be automatically transferred to this product. • Update the phone book manually.
	<p>Using call history Make a phone call from the received call , dialed call , or missed call .</p>
	<p>Direct phone number input Touch the number keys to enter the phone number then touch  to make a call.</p>



▶ To end the call

- 1 Touch .

Receiving a phone call

- 1 Touch  to answer the call.
Touch  to end the call.

TIPS

- Touch  while getting a call waiting, switch to the talking person.
- Touch  while getting a call waiting to reject the call.

Phone settings

- 1 Touch .
- 2 Touch  then [Bluetooth Settings].

Menu Item	Description
[Auto Answer]	Activate to answer an incoming call automatically.

Adjusting the other party's listening volume

This product can be adjusted to the other party's listening volume.

- 1 Touch  to switch between the three volume levels.

Notes for hands-free phoning

► General notes

- Connection to all cellular phones featuring Bluetooth wireless technology is not guaranteed.
- The line-of-sight distance between this product and your cellular phone must be 10 meters or less when sending and receiving voice and data via Bluetooth technology.
- With some cellular phones, the ring sound may not be output from the speakers.
- If private mode is selected on the cellular phone, hands-free phoning may be disabled.

► Registration and connection

- Cellular phone operations vary depending on the type of cellular phone. Refer to the instruction manual that came with your cellular phone for detailed instructions.
- When phone book transfer does not work, disconnect your phone and then perform pairing again from your phone to this product.

► Making and receiving calls

- You may hear a noise in the following situations:
 - When you answer the phone using the button on the phone.
 - When the person on the other end of the line hangs up the phone.
- If the person on the other end of the line cannot hear the conversation due to an echo, decrease the volume level for hands-free phoning.
- With some cellular phones, even after you press the accept button on the cellular phone when a call comes in, hands-free phoning may not be performed.

► The received call and dialed number histories

You cannot make a call to the entry of an unknown user (no phone number) in the received call history.

► Phone book transfers

- If there are more than 1 000 phone book entries on your cellular phone, not all entries may download completely.
- Depending on the phone, this product may not display the phone book correctly.

- If the phone book in the phone contains image data, the phone book may not be transferred correctly.
- Depending on the cellular phone, phone book transfer may not be available.

Bluetooth audio

Before using the Bluetooth audio player, register and connect the device to this product (page 14).

NOTES

- Depending on the Bluetooth audio player connected to this product, the available operations with this product may be limited to the following two levels:
 - A2DP (Advanced Audio Distribution Profile): Only playing back songs on your audio player is possible.
 - A2DP and AVRCP (Audio/Video Remote Control Profile): Playing back, pausing, selecting songs, etc., are possible.
- Depending on the Bluetooth device connected to this product, the available operations with this product may be limited or differ from the descriptions in this manual.
- While you are listening to songs on your Bluetooth device, refrain from operating the phone function as much as possible. If you try operating, the signal may cause noise for song playback.
- When you are talking on the Bluetooth device connected to this product via Bluetooth, it may pause playback.

1 Touch .

2 Touch [Bluetooth Audio].

The Bluetooth audio playback screen appears.





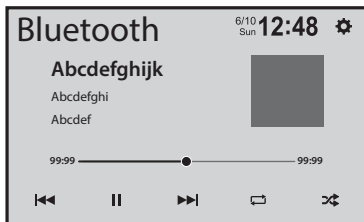

TIP

If [Bluetooth Audio] on the top menu screen is not available, try the followings:

- Pull out the cellular phone from the USB cable.
- Confirm whether Bluetooth audio is activated (page 13).

Basic operation



 	Switches between playback and pause.
 	Skips files forward or backward.
 	Sets a repeat play range.
	Plays files in random order.

Wi-Fi®

By connecting your Wi-Fi certified mobile device to this product via Wi-Fi connection, you can use Apple CarPlay or Android Auto wirelessly.

Wi-Fi connection

See the following chapters for the procedure on how to make a Wi-Fi connection for each application.

- Apple CarPlay (page 34)
- Android Auto (page 37)

Wi-Fi Settings

- 1 Touch .
- 2 Touch .
- 3 Touch [Wi-Fi Settings].

Menu Item	Description
[Wi-Fi]	Switches Wi-Fi connection on or off.
[Device Information]	Displays the network name and MAC address of this product.
[Password]	Displays a Wi-Fi connection password.
[Password reset]	Touch to reset the Wi-Fi connection password.

AV source

Supported AV source

You can play or use the following sources with this product.

- Radio
- USB

The following sources can be played back or used by connecting an auxiliary device.

- iPhone
- Bluetooth audio
- SiriusXM Satellite Radio
- Camera View
- AUX

Selecting a source

1 Touch .

2 Touch the source icon.

TIP

You can display the hidden source icon(s) by swiping left on the screen.













Radio

Starting procedure

- 1 Press .
- 2 Touch [Radio].
The Radio screen appears.

Basic operation



	 Recalls the preset channel stored to a key from memory.
	 Stores the current broadcast frequency to a key.
	Selects the FM1, FM2, FM3, AM1 or AM2 band.
	 Performs BSM (best stations memory) function (page 23).
	 Manual tuning
	 Seek tuning Skips to the nearest station from the current frequency.
	Activates/deactivates the local seek mode.

Storing the strongest broadcast frequencies (BSM)

The BSM (best stations memory) function automatically stores the six strongest broadcast frequencies under the preset channel keys [1] to [6].

NOTES

- Storing broadcast frequencies with BSM may replace those you have already saved.
- Previously stored broadcast frequencies may remain stored if the number of frequencies stored has not reached the limit.

1 Touch **BSM** to begin search.

While the message is displayed, the six strongest broadcast frequencies will be stored under the preset channel keys in the order of their signal strength.

Compressed files

Plugging/unplugging a USB storage device

You can play compressed audio, compressed video, or still image files stored in an external storage device.

Plugging a USB storage device

- 1 Pull out the plug from the USB port of the USB cable.
- 2 Plug a USB storage device into the USB cable.

NOTES

- This product may not achieve optimum performance with some USB storage devices.
- Connection via a USB hub is not possible.
- A USB cable is required for connection.

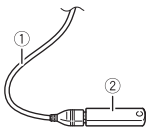

①	USB cable
②	USB storage device

Unplugging a USB storage device

- 1 Pull out the USB storage device from the USB cable.

NOTES

- Check that no data is being accessed before pulling out the USB storage device.
- Turn off (ACC OFF) the ignition switch before unplugging the USB storage device.

Starting procedure

- 1 Plug the USB storage device into the USB cable.









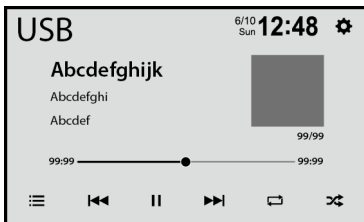

TIP

You can also start this source by pressing  then touching [USB].

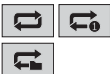
Basic operation

Audio source



	Switches between playback and pause.
	 Skips files forward or backward.
	 Performs fast forward or fast reverse.
	Sets a repeat play range for all files/the current folder/the current file.
	Plays files or does not play in random order.
	Selects a file from the list. Touch a file on the list to playback. TIPS <ul style="list-style-type: none">• Touching a folder on the list shows its contents. You can play a file on the list by touching it.• You can switch the following media file types.<ul style="list-style-type: none">- : Compressed audio files- : Compressed video files- : Image files













CAUTION

For safety reasons, video images cannot be viewed while your vehicle is in motion. To view video images, stop in a safe place and apply the parking brake.



	<p>Switches between playback and pause.</p>
	<p>Skips files forward or backward.</p>
	<p>Performs fast forward or fast reverse.</p>
	<p>Sets a repeat play range for all files/the current folder/the current file.</p>
	<p>Selects a file from the list. Touch a file on the list to playback.</p> <p>TIPS</p> <ul style="list-style-type: none"> • Touching a folder on the list shows its contents. You can play a file on the list by touching it. • You can switch the following media file types. <ul style="list-style-type: none"> - : Compressed audio files - : Compressed video files - : Image files
	<p>You can adjust [Brightness]/[Contrast]/[Color] by touching [+]/[-].</p>



 	<p>Switches between playback and pause.</p>
 	<p>Skips files forward or backward.</p>
	<p>Rotates the displayed picture 90° counterclockwise.</p>
  	<p>Sets a repeat play range for all files/the current folder/the current file.</p>
	<p>Selects a file from the list. Touch a file on the list to playback.</p> <p>TIPS</p> <ul style="list-style-type: none"> • Touching a folder on the list shows its contents. You can play a file on the list by touching it. • You can switch the following media file types. <ul style="list-style-type: none"> - : Compressed audio files - : Compressed video files - : Image files

iPhone

NOTE

iPhone may be referred to as iPod in this manual.

Connecting your iPhone

When connecting an iPhone to this product, the settings are automatically configured according to the device to be connected. For details of the compatibility, refer to Compatible iPhone models (page 63).

1 Connect your iPhone via USB.

If the iPod screen is automatically displayed, you do not need to perform the following steps.

2 Touch .

3 Touch [iPod].

NOTE



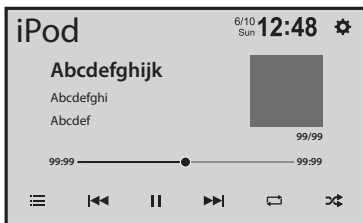

For USB connection, refer to the Installation Manual.

Basic operation

Audio source



Switches between playback and pause.

	Skips files forward or backward.
	Sets a repeat play range for all in the selected list/the current song.
	Plays songs within the selected list/album randomly.
	Selects a song from the list. Touch the category then the title of the list to playback of the selected list. TIP You can search a song in the songs list by dragging the initial search bar. NOTES <ul style="list-style-type: none">• Depending on the generation or version of the iPhone, some functions may not be available.• Only 2 000 songs in the iPhone are available in the list if the iPhone has more than 2 000 songs. Available songs depend on the iPhone.

WebLink™

You can operate WebLink compatible applications with finger gestures such as tapping, dragging, scrolling, or flicking on the screen of this product.

NOTES

- The supported finger gestures may vary depending on the WebLink compatible application.
- To use WebLink, you must first install the WebLink Host app on the iPhone or smartphone. For details about the WebLink Host app, visit the following site: <https://www.abaltatech.com/weblink/>
- Be sure to read Using app-based connected content (page 63) before you perform this operation.
- Copyright protected files such as DRM cannot be played.

WARNING

Certain uses of the iPhone or smartphone may not be legal while driving in your jurisdiction, so you must be aware of and obey any such restrictions. If in doubt as to a particular function, only perform it while the car is parked. No feature should be used unless it is safe to do so under the driving conditions you are experiencing.

Using WebLink

Important

- Pioneer is not responsible for content or functions accessed via WebLink, which are the responsibility of the application and content providers.
- Availability of non-Pioneer content and services, including apps and connectivity, may change or discontinue without notice.
- When using WebLink with the Pioneer product, available content and functions will be limited while driving.
- WebLink allows access to applications other than those listed, subject to limitations while driving.

Starting procedure

For iPhone users

System requirement

iOS 14 or higher

- 1 Unlock your iPhone and connect it to this product via USB.

TIP

You can start this source by touching , swiping left on the screen, and touching [WebLink] if the screen except for WebLink appears after the USB connection.

NOTE

For USB connection, refer to the Installation Manual.

For smartphone (Android™) users**System requirement**

Android 7.0 or higher

NOTE

The video playback capability depends on the connected Android device.

1 Unlock your smartphone and connect it to this product via USB.**TIP**

You can start this source by touching , swiping left on the screen, and touching [WebLink] if the screen except for WebLink appears after the USB connection.

NOTES

- For USB connection, refer to the Installation Manual.
- Make sure that file transfer mode for USB connection is enabled on your smartphone if WebLink does not start automatically.

Basic operation

Touch the desired application icon after the WebLink app is launched. The desired application is launched, and the application operation screen appears.



Displays the main menu of the WebLink source screen.

TIPS

- If you connect your device to this product while a WebLink compatible application is already running, the application operation screen will appear on this product.
- Check the Bluetooth connection between the mobile device and this unit if there is no sound output from this unit (page 14).

USB Mirroring

You can operate Android applications with finger gestures such as tapping, dragging, scrolling, or flicking on the screen of this product.

NOTES

- The supported finger gestures may vary depending on the application for the smartphone.
- To use USB Mirroring, you must first install the application on the smartphone.
- Be sure to read Using app-based connected content (page 63) before you perform this operation.

WARNING

Certain uses of the smartphone may not be legal while driving in your jurisdiction, so you must be aware of and obey any such restrictions. If in doubt as to a particular function, only perform it while the car is parked. No feature should be used unless it is safe to do so under the driving conditions you are experiencing.

Using USB Mirroring

Important

- Pioneer is not responsible for content or functions accessed via USB Mirroring, which are the responsibility of the application and content providers.
- Availability of non-Pioneer content and services, including apps and connectivity, may change or discontinue without notice.
- When using USB Mirroring with the Pioneer product, available content and functions will be limited while driving.

Starting procedure

System requirement

Android 5.0 or higher

NOTES

- [Android Phone MSC] is deactivated to enable use of this function (page 51).
- The video playback capability depends on the connected Android device.

1 Unlock your smartphone and connect it to this product via USB.

Follow the instruction on the display when the message is come up on your connected smartphone.

TIP

You can start this source by touching , swiping left on the screen and touching [Mirroring] if the screen except for Mirroring appears after the USB connection.

NOTE

For USB connection, refer to the Installation Manual.

Apple CarPlay

You can operate iPhone applications with finger gestures such as tapping, dragging, scrolling, or flicking on the screen of this product.

Compatible iPhone models

For details about compatibility of iPhone models, refer to the following website.
<https://www.apple.com/ios/carplay>

NOTE

The compatible finger gestures vary depending on the application for the iPhone.

WARNING

Certain uses of the iPhone may not be legal while driving in your jurisdiction, so you must be aware of and obey any such restrictions. If in doubt as to a particular function, only perform it while the car is parked. No feature should be used unless it is safe to do so under the driving conditions you are experiencing.

Using Apple CarPlay

Important

Apple CarPlay may not be available in your country or region.

For details about Apple CarPlay, visit the following site:

<https://www.apple.com/ios/carplay>

- The content and functionality of the supported applications are the responsibility of the App providers.
- In Apple CarPlay, usage is limited while driving, with availability of functions and content determined by the App providers.
- Apple CarPlay allows access to applications other than those listed that are subject to limitations while driving.
- PIONEER IS NOT RESPONSIBLE AND DISCLAIMS LIABILITY FOR THIRD PARTY (NON-PIONEER) APPS AND CONTENT, INCLUDING WITHOUT LIMITATION ANY INACCURACIES OR INCOMPLETE INFORMATION.

Setting the driving position

To achieve optimum usability of Apple CarPlay, set the driving position setting correctly according to the vehicle. The setting will be applied the next time an Apple CarPlay compatible device is connected to this product.

1 Touch .

2 Touch .

3 Touch [Phone Connectivity Settings].

- 4 Touch [Driving Position].**
[Left]
Select for a left-hand drive vehicle.
[Right]
Select for a right-hand drive vehicle.

Starting procedure

Wired connection



- 1 Connect an Apple CarPlay compatible device to this product via USB.**
The application screen appears.

TIP

You can start this source by touching  then touching [Apple CarPlay] if the screen except for Apple CarPlay appears after the USB connection.

Wireless connection

Before using Apple CarPlay wirelessly, perform the following:

- Attach the GPS antenna to this product.
 - Turn on Apple CarPlay in the setting menu of your iPhone.
- 1 Turn on the Wi-Fi function and the Bluetooth function on the device.**
- 2 Display the Bluetooth setting menu on the device.**
- 3 Touch .**
- 4 Touch .**
The device search screen appears.
- 5 Touch [Yes] to start searching.**
Touch  if another device is already connected to the unit.
- 6 Touch a desired device on the screen.**

NOTE

A pop-up message may appear if another device is already connected to the unit. Touch [OK] on the message.

- 7 Touch [Yes] to pair with the device.**
- 8 Perform the pairing operation by operating the device.**
- 9 Touch [Yes] to activate the Apple CarPlay function.**

Follow the on-screen instructions on the device to start the application.

TIPS

- When the USB connection with the other device has been made, the message that shows that the new device is available will appear. If you want to switch from the current device to the new one for use in the application, touch the pop-up message.
- You can use Siri function by touching  button once Apple CarPlay is activated.

NOTES

- For details on USB connection, refer to the Installation Manual.
- If five devices are already paired, the message confirming whether to delete the registered device is displayed. If you want to delete the device, touch [Agree]. If you want to delete other device, touch [Go To DeviceList] and delete the devices manually (page 13).
- If an Apple CarPlay compatible device has been connected and another screen is displayed, touch [Apple CarPlay] on the top menu screen to display the Application menu screen.
- Hands-free phoning via Bluetooth wireless technology is not available while Apple CarPlay is on. If Apple CarPlay is turned on during a call on a cellular phone other than an Apple CarPlay compatible device, the Bluetooth connection will be terminated after the call ends.

Android Auto™

You can operate Android applications with finger gestures such as tapping, dragging, scrolling, or flicking on the screen of this product.

Compatible Android devices

For details about compatibility of Android models, refer to the following website.
<https://support.google.com/androidauto>

For wireless connections

To wirelessly use Android Auto on your car display, you need a compatible Android smartphone with an active data plan. You can check which smartphones are compatible at g.co/androidauto/requirements.

NOTES

- [Android Phone MSC] is deactivated to enable use of this function (page 51).
- The compatible finger gestures vary depending on the application for the smartphone.



WARNING

Certain uses of the smartphone may not be legal while driving in your jurisdiction, so you must be aware of and obey any such restrictions. If in doubt as to a particular function, only perform it while the car is parked. No feature should be used unless it is safe to do so under the driving conditions you are experiencing.

Using Android Auto



Important

Android Auto may not be available in your country or region.



For details about Android Auto, please refer to the Google support site:

<http://support.google.com/androidauto>

- The content and functionality of the supported applications are the responsibility of the App providers.
- In Android Auto, usage is limited while driving, with availability of functions and content determined by the App providers.
- Android Auto allows access to applications other than those listed that are subject to limitations while driving.
- PIONEER IS NOT RESPONSIBLE AND DISCLAIMS LIABILITY FOR THIRD PARTY (NON-PIONEER) APPS AND CONTENT, INCLUDING WITHOUT LIMITATION ANY INACCURACIES OR INCOMPLETE INFORMATION.

Setting the driving position

To achieve optimum usability of Android Auto, set the driving position setting correctly according to the vehicle. The setting will be applied the next time an Android Auto compatible device is connected to this product.

- 1 Touch .
- 2 Touch .
- 3 Touch [Phone Connectivity Settings].
- 4 Touch [Driving Position].
[Left]
Select for a left-hand drive vehicle.
[Right]
Select for a right-hand drive vehicle.

Starting procedure



Wired connection

- 1 Connect an Android Auto compatible device to this product via USB.
The application screen appears.

TIP

You can start this source by touching  then touching [Android Auto] if the screen except for Android Auto appears after the USB connection.

Wireless connection

- 1 Turn on the Wi-Fi function and the Bluetooth function on the device.
- 2 Display the connected Bluetooth devices list screen on the device.
- 3 Touch .
- 4 Touch .
- The device search screen appears.
- 5 Touch [Yes] to start searching.
Touch  if another device is already connected to the unit.
- 6 Touch a desired device on the screen.

NOTE

A pop-up message may appear if another device is already connected to the unit. Touch [OK] on the message.

- 7 Touch [Yes] to pair with the device.
- 8 Perform the pairing operation by operating the device.

9 Touch [Start] to start Android Auto.

The unit configures the connection then start the application.

TIP

You can use voice recognition function by touching  button once Android Auto is activated.

NOTES

- For details on USB connection, refer to the Installation Manual.
- If five devices are already paired, the message confirming whether to delete the registered device is displayed. If you want to delete the device, touch [Agree]. If you want to delete other device, touch [Go To DeviceList] and delete the devices manually (page 13).
- If Android Auto is turned on during a call on a cellular phone other than the Android Auto compatible device, the Bluetooth connection will switch to the Android Auto compatible device after the call.

SiriusXM[®] Satellite Radio

SiriusXM is where moments happen. The widest, deepest variety of music, ad-free. More games, more sports, more coverage than anywhere. The most extensive entertainment, complete news coverage and every kind of comedy. Listen in your car, on your phone, online and at home. A SiriusXM Vehicle Tuner and subscription are required. For more information, visit www.siriusxm.com

Subscribing to the SiriusXM Satellite Radio service

1 Touch .

2 Touch [SiriusXM].

You should be able to tune in to Channel 1. If you cannot get Channel 1, ensure that your SiriusXM Connect Vehicle Tuner is installed correctly.

3 Switch to Channel 0 and check the Radio ID.

The SiriusXM Radio ID can be found by tuning in to Channel 0. You will need this number to activate your subscription.

NOTE

The SiriusXM Radio ID does not include the letters I, O, S, or F.

4 Activate the service either online or by phone.

TIP

In the USA, you can activate online or by calling SiriusXM Listener Care:

- Visit the website www.siriusxm.com/activatenow
- Call SiriusXM Listener Care at 1-866-635-2349

For Canadian Subscriptions, please contact:

- Visit www.siriusxm.ca/activate
- Call SiriusXM Customer Care at 1-888-539-7474

NOTES

- The SiriusXM satellites will send an activation message to your tuner. When the tuner has received the message, [Subscription Updated] is displayed.
- The activation process usually takes 10 to 15 minutes, but it may take up to an hour. Do not turn off this product while the activation message is displayed.

Listening to SiriusXM

- 1 Touch .
- 2 Touch [SiriusXM].









Basic operation

TIP

[RADIO ID] is displayed when Channel 0 is selected.

Current channel display (Live broadcast mode)



	Tunes a channel directly.
	 Recalls the preset channel stored to a key from the memory.
	 Stores the current channel to a key.
	Selects a band. There are 3 bands. You can store 6 channels per band for a total of 18 presets.
	 Performs channel number up/down.
	 Performs fast channel number up/down.



Select a channel from the list.

Scroll through the list of all channels then touch the desired channel to tune to that channel.

TIP

When is selected, the channel list will be shown according to different categories.

Touch or to select other Category.

NOTES

- The types of categories available depend on the types of channels available.
- It may take time to display the channel list depending on the SiriusXM reception condition.

Parental Control

The Parental Control feature allows you to limit access to any SiriusXM channels, including those with mature content. When enabled, the Parental Control feature requires you to enter a passcode to tune to the locked channels.

For details, see [Parental Control] in SiriusXM settings (page 41).

SiriusXM settings

1 Touch .

2 Touch [SiriusXM] then touch .

The menu items vary depending on whether SiriusXM is selected as the source.

Menu Item	Description
[Change Passcode]	Edit the passcode. <ol style="list-style-type: none"> 1 Enter the current passcode and then touch [OK]. 2 Enter the new passcode and then touch [OK]. 3 Enter the confirm passcode and then touch [OK].
[Parental Control]	Enter the current passcode then touch [OK] to set this function (the default passcode is 0000). <ul style="list-style-type: none"> • To lock the channel, touch the appropriate channel. appears and the channel is locked. <p>TIP</p> <p>When you touch the locked channel, the channel is unlocked.</p>
[Clear Locked All]	Touch the switch, enter the current passcode then touch [OK], all locked channels are unlocked.
[Version]	Displaying the firmware version and the model number, etc.

AUX

You can display the video image output by the device connected to video input.

CAUTION

For safety reasons, video images cannot be viewed while your vehicle is in motion. To view video images, stop in a safe place and apply the parking brake.

NOTE

A Mini-jack AV cable (sold separately) is required for connection. For details, refer to the Installation Manual.

Starting procedure

- 1 Touch  then swipe left on the screen.
- 2 Touch [AUX].
The AUX screen appears.

Camera View

You can display the video image output by the device connected to video or camera input. For details, refer to the Installation Manual.



Starting procedure

- 1 Touch  then swipe left on the screen.
- 2 Touch [Camera View] for connected camera view.
The video image is displayed on the screen.

Settings

You can adjust various settings in the main menu.

Displaying the setting screen

- 1 Touch .
- 2 Touch .
- 3 Touch one of the following categories, then select the options.
 - System Settings (page 44)
 - Display Settings (page 46)
 - Audio & EQ Settings (page 47)
 - Wi-Fi Settings (page 20)
 - Bluetooth Settings (page 15)
 - Camera settings (page 48)
 - Phone Connectivity Settings (page 51)

System Settings





Menu Item	Description
[Choose Language]	Select the system language. NOTES <ul style="list-style-type: none"> • If the embedded language and the selected language setting are not the same, the text information may not display properly. • Some characters may not be displayed properly.
[Date & Time]	Setting or adjusting the following time and clock display. <ul style="list-style-type: none"> • Date display format: [d/m/y] (day-month-year) or [m/d/y] (month-day-year) • Time display format: [12hour] or [24hour] • UTC (Universal Time Coordinated) time zone difference: UTC-12.00h to UTC+14.00h • Day-light saving time: [On] or [Off]
[Beep Tone]	Set off to disable the beep sound when the button is touched or the screen is touched.
[SiriusXM settings]	(page 41)

Menu Item	Description
[Factory Reset]	<p>Touch [OK] to restore the settings to the default settings.</p> <p> CAUTION Do not turn off the engine while restoring the settings.</p> <p>NOTES</p> <ul style="list-style-type: none"> • This setting is available only when you stop your vehicle in a safe place and apply the parking brake. • The source is turned off and the Bluetooth connection is disconnected before the process starts. • Before starting the restore process, disconnect any device that is connected to the USB port. Otherwise, some settings may not be restored correctly.
[Connection Status]	<p>Check that the leads are properly connected between this product and vehicle.</p>
[GPS Antenna]	<p>Displays the connection status of the GPS antenna ([OK] or [NOK]) and the reception sensitivity.</p> <p>NOTE If reception is poor, change the installation position of the GPS antenna.</p>
[Positioning Status]	<p>Displays the positioning status (3D positioning, 2D positioning, or no positioning), the number of satellites used for positioning (orange), and the number of satellites that have received signals (yellow). If signals from more than six satellites are received, the current location can be measured.</p>
[Installation]	<p>Indicates whether the inertial navigation is successfully learned. If the learning is successful, [OK] will appear. If the learning is not successful or due to failure after the learning is successful, [NOK] will appear.</p> <p>NOTE If this product is not firmly fixed into place or the speed pulse wire is not connected or properly connected, [NOK] is displayed due to the learning failure.</p>
[Speed Pulse]	<p>The speed pulse value detected by this product is shown.</p> <p>NOTE Check that the speed pulse wire is properly connected if [0] is still displayed while driving.</p>
[Back Signal]	<p>When the shift lever is shifted to "R" (reverse position), the signal switches to [High] or [Low]. The signal displayed varies depending on the vehicle.</p>





Menu Item	Description
[System Information]	<p>Displaying and updating the firmware version.</p> <p> CAUTION</p> <ul style="list-style-type: none"> • The USB storage device for updating must contain only the correct update file. • Never turn this product off, disconnect the USB storage device while the firmware is being updated. • You can only update the firmware when the vehicle is stopped and the parking brake is engaged. <ol style="list-style-type: none"> 1 Download the firmware update files into your computer. 2 Connect a blank (formatted) USB storage device to your computer then locate the correct update file and copy it onto the USB storage device. 3 Connect the USB storage device to this product (page 24). 4 Display the [System Settings] screen (page 44). 5 Touch [System Information]. 6 Touch [Update]. New firmware version information is displayed. 7 Touch [Update]. Follow the on-screen instructions to finish updating the firmware. <p>NOTES</p> <ul style="list-style-type: none"> • This product will reset automatically after the firmware update is completed if the update is successful. • If an error message appears on the screen, touch the display and perform the above steps again.
[License]	Displaying the open source license.



Display Settings

Menu Item	Description
[Lighting Detect]	Activate to set the dimmer function on automatically when the head lamps of the vehicle are lit.
[Day Illumination]	Touch [+]/[-] to adjust the brightness of the display in the day time.
[Night Illumination]	Touch [+]/[-] to adjust the brightness of the display in the night time.
[Illumination]	Select an illumination color from the preset list.

Menu Item	Description
[Wallpaper]	Touch the wall paper from the preset items in this product or original pictures via the external device and touch [Apply]. The wall paper can be set from selections for the top menu screen and AV operation screen.
Preset Display	Select the desired preset background display. You can set your favorite screen from the connected USB device by touching and sliding the bottom of screen to the right.
	Select the background display image of the connected USB storage device. 1 Connect the USB storage device to this product (page 24). 2 Touch . 3 Select the desired image.
 (custom)	Displays the background display image imported from the USB storage device.
 (off)	Hides the background display.

Audio & EQ Settings

Menu Item	Description
[Fader/Balance]	Touch  or  to adjust the front/rear speaker balance. Set [Front] and [Rear] to [0] when using a dual speaker system. Touch  or  to adjust the left/right speaker balance. TIP You can also set the value by dragging the point on the displayed table.
[Sub/X-Over]	
[Subwoofer]	Select enable or disable rear subwoofer output from this product.
[Front HPF]	Adjust the speaker output level of the listening position by touching [+]/[-].
[Rear HPF]	
[Subwoofer LPF]	

Menu Item	Description
[EQ] [Super Bass] [Powerful] [Natural] [Vocal] [Flat] [Custom]	Select or customize the equalizer curve. Select a curve that you want to use as the basis of customizing then touch the frequency that you want to adjust. TIP If you make adjustments when a curve [Super Bass], [Powerful], [Natural], [Vocal], or [Flat] is selected, the equalizer curve settings will be changed to [Custom] mandatorily.
[Volume] [Main Volume] [Ring Volume] [Talking Volume] [Navi/Voice Volume] [TA Volume]	Adjust the volume level by touching [+]/[-].
[Speaker Level] Types of speaker [Front Left] [Front Right] [Rear Left] [Rear Right] [Subwoofer]	Adjust the speaker output level of the listening position. 1 Touch  or  to adjust the selected speaker output level. NOTE [Subwoofer] is available when [Subwoofer] in the [Sub/X-Over] setting is activated.
[Loudness] [Off] [Low] [Mid] [High]	Compensates for deficiencies in the low-frequency and high-frequency ranges at low volume.
[Bass Boost] [0] to [6]	Adjust the bass boost level.

Camera settings

A separately sold rear view camera is required for utilizing the rear view camera function. (For details, consult your dealer.)

► Rear view camera

This product features a function that automatically switches to the full-screen image of the rear view camera installed on your vehicle when the shift lever is in the REVERSE (R) position.

Camera View mode also allows you to check what is behind you while driving.

TIP

The parking assist guidelines can be displayed temporarily on the rear view camera screen by touching the icon at the top left of the screen. When you reverse the gear and display the rear view camera screen immediately after turning on the ignition switch, it takes approximately 10 seconds to be available for the icon. The guidelines can be adjusted. For details on how to adjust the guidelines, see [Parking Assist Guide Adjust] (page 50).

► Camera for Camera View mode

Camera View can be displayed at all times. Note that with this setting, the camera image is not resized to fit, and that a portion of what is seen by the camera is not viewable. To display the camera image, touch [Camera View] on the top menu screen (page 12).

NOTE

To set the rear view camera as the camera for Camera View mode, activate [Back-up Camera Input] (page 49).



CAUTION

Pioneer recommends the use of a camera which outputs mirror reversed images, otherwise the screen image may appear reversed.

- Immediately verify whether the display changes to the rear view camera image when the shift lever is moved to REVERSE (R) from another position.

Menu Item	Description
[Back-up Camera Input]	Setting rear view camera activation.
[Camera View] [Normal] [Reverse]	Select the way the screen image of a camera appears.

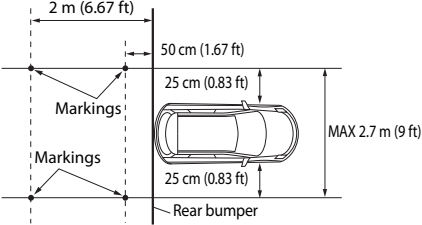
Menu Item	Description
<p>[Parking Assist Guide Adjust]</p>	<p>1 Adjusting the guidelines by dragging or touching ▲/▼/◀/▶ on the screen.</p> <p>2 Touch [OK] to finish the settings.</p> <p>TIP Touch [Reset] to reset the settings.</p> <p>⚠ CAUTION</p> <ul style="list-style-type: none"> When adjusting the guidelines, park the vehicle in a safe place and apply the parking brake; this setting is available only when the vehicle is parked with the parking brake applied. Turn the vehicle off before getting out to place the markings. The range projected by the rear view camera is limited. Also, the vehicle width and distance guidelines displayed on the rear view camera image may differ from the actual vehicle width and distance. (The guidelines are straight lines.) The image quality may deteriorate depending on the usage environment, such as at night or in dark surroundings. <p>NOTES</p> <ul style="list-style-type: none"> Use painter's tape or similar tape to place markings as shown below before setting up the guidelines. Adjust the guidelines so that they overlay the tape markings as closely as possible. Install the rear view camera as near the center of the vehicle as possible, and do not install it too low. Otherwise, the guideline comes on the edge of the screen, preventing the guideline from being adjusted. 
<p>[Rear View Camera Adjustment]</p>	<p>Adjust following menu, touch [+] / [-] to adjust.</p> <p>NOTE This setting is available only when you stop your vehicle in a safe place and apply the parking brake.</p>
<p>[Brightness [-10] to [+10]</p>	<p>Adjust the black intensity.</p>

Menu Item	Description
[Contrast] [-10] to [+10]	Adjust the contrast.
[Color] [-10] to [+10]	Adjust the color saturation.

Phone Connectivity Settings

Menu Item	Description
[Android Phone MSC]	Set the USB connection mode for your smartphone (Android) to MSC (Mass Storage Class). NOTE This setting is not available when Android device or USB storage device is connected to this product via USB.
[Driving Position] [Right] [Left]	Setting the driving position. <ul style="list-style-type: none">• Apple CarPlay (page 33)• Android Auto (page 36)

Other functions

Setting the clock display

You can set the time format, time zone, daylight saving, and the date format. However, the time and date are automatically adjusted by the GPS antenna and cannot be adjusted by the user.

1 Touch the current time on the screen.

2 Set the following items in the settings.

- The date display format:
[d/m/y] (day-month-year) or [m/d/y] (month-day-year)
- The time display format:
[12hour] or [24hour]
- The UTC (Universal Time Coordinated) time zone difference:
UTC-12.00h to UTC+14.00h
- Day-light saving time:
[On] or [Off]

You can also configure these items in [Date & Time] (page 44).

Restoring this product to the default settings

You can restore settings or recorded content to the default settings from [Factory Reset] in the [System Settings] menu (page 45).

Appendix

Troubleshooting

If you have problems operating this product, refer to this section. The most common problems are listed below, along with likely causes and solutions. If a solution to your problem cannot be found here, contact your dealer or the nearest authorized Pioneer service facility.

Common problems

A black screen is displayed, and operation is not possible using the touch panel keys.

- Power off mode is on.
 - Touch  on this product to release the mode.

Problems with the AV screen

The screen is covered by a caution message and the video cannot be shown.

- The parking brake lead is not connected or the parking brake is not applied.
 - Connect the parking brake lead correctly, and apply the parking brake.
- The parking brake interlock is activated.
 - Park your vehicle in a safe place and apply the parking brake.

The audio or video skips.

- This product is not firmly secured.
 - Secure this product firmly.

No sounds are produced. The volume level will not rise.

- Cables are not connected correctly.
 - Connect the cables correctly.

iPhone cannot be operated.

- The iPhone is frozen.
 - Reconnect the iPhone with the USB interface cable for iPhone.
 - Update the iPhone software version.
- An error has occurred.
 - Reconnect the iPhone with the USB interface cable for iPhone.
 - Park your vehicle in a safe place, and then turn off the ignition switch (ACC OFF). Subsequently, turn the ignition switch to on (ACC ON) again.
 - Update the iPhone software version.
- Cables are not connected correctly.
 - Connect the cables correctly.

Sound from the iPhone cannot be heard.

- The audio output direction may switch automatically when the Bluetooth and USB connections are used at the same time.
 - Use the iPhone to change the audio output direction.

No back camera image when the vehicle is in reverse.

- The back camera input setting on the receiver is set to Off.
 - Change the back camera setting to On in the settings menu. (Refer to the System Settings section of this manual to adjust.)
- The camera input may be loose or not connected.
 - Check the connection and make sure the male end of the camera is connected to the brown input on the back of the receiver. (Refer to the installation manual.)
- The reverse lead on the receiver may not be connected to the proper wire at the reverse lamp.

- Check the connection and make sure that the violet/white lead of the receiver is connected to the lead whose voltage changes when the shift lever is put in reverse. (Refer to the installation manual.)

Black screen displayed when the vehicle is in reverse, with no camera installed.

- Back camera input is set to On.
 - Turn the setting to Off in the settings menu. (Refer to the System Settings section of this manual to adjust.)

Problems with the phone screen

Dialing is impossible because the touch panel keys for dialing are inactive.

- Your phone is out of range for service.
 - Retry after re-entering the range for service.
- The connection between the cellular phone and this product cannot be established.
 - Perform the connection process.

Problems with Application screen

A black screen is displayed.

- While operating an application, the application was ended on the smartphone side.
 - Touch **■** to display the top menu screen.
- The smartphone OS may be awaiting screen operation.
 - Stop the vehicle in a safe place and check the screen on the smartphone.

The screen is displayed, but operation does not work at all.

- An error has occurred.
 - Park your vehicle in a safe place, and then turn off the ignition switch (ACC

OFF). Subsequently, turn the ignition switch to on (ACC ON) again.

The smartphone was not charged.

- Charging stopped because the temperature of the smartphone rose due to prolonged use of the smartphone during charging.
 - Disconnect the smartphone from the cable, and wait until the smartphone cools down.
- More battery power was consumed than was gained from charging.
 - This problem may be resolved by stopping any unnecessary services on the smartphone.

Error messages

When problems occur with this product, an error message appears on the display. Refer to the table below to identify the problem, then take the suggested corrective action. If the error persists, record the error message and contact your dealer or your nearest Pioneer service center.

SiriusXM Satellite Radio

Check Antenna

- The antenna connection is incorrect.
 - Check the antenna connection. If the message fails to disappear even after the engine is switched off/on, contact your dealer or the nearest authorized Pioneer service center for assistance.

Check Tuner

- The SiriusXM Connect Vehicle Tuner connection is incorrect.
 - Check the tuner connection and battery voltage. If the message fails to disappear even after the engine is switched off/on, contact your dealer

or the nearest authorized Pioneer service center for assistance.

www.siriusxm.ca or call 1-888-539-7474.

No Signal

- The SiriusXM Connect Vehicle Tuner is having difficulty receiving the SiriusXM satellite signal.
 - Verify that your vehicle is outdoors with a clear view of the southern sky.
 - Verify that the SiriusXM magnetic mount antenna is mounted on a metal surface on the outside of the vehicle.
 - Move the SiriusXM antenna away from any obstructions.

Channel Not Available

- The channel that you have requested is not a valid SiriusXM channel.
 - Visit www.siriusxm.com for more information about the SiriusXM channel lineup.

Subscription Updated Press Enter to Continue

- This product has detected a change in your SiriusXM subscription status.
 - Touch [Yes] to clear the message.In the U.S.A., visit www.siriusxm.com or call 1-866-635-2349 if you have questions about your subscription. In Canada, visit www.siriusxm.ca or call 1-888-539-7474 if you have questions about your subscription.

Channel Not Subscribed Call SiriusXM to Subscribe

- The channel that you have requested is not included in your SiriusXM subscription package.
 - Check the content of your SiriusXM subscription package.In the U.S.A., visit www.siriusxm.com or call 1-866-635-2349 if you have questions about your subscription package or would like to subscribe to this channel. In Canada, visit

Channel Locked Please Enter the Lock Code

- Locked by the radio Parental Control feature.
 - Release the channel lock.

Incorrect Pass Code entered

- The pass code is incorrect.
 - Enter the correct pass code.

USB storage device

Unsupport USB device

- The connected USB device is not supported by this product.
 - Check the supported USB formats (page 65).

Unsupport USB hub device

- The connected USB hub is not supported by this product.
 - Directly connect the USB storage device to this product.

This content cannot be played.

- There is no playable file in the USB storage device.
 - Check that the files in the USB storage device are compatible with this product.
- This type of file is not supported on this product.
 - Select a file that can be played.
- Security for the connected USB storage device is enabled.
 - Follow the USB storage device instructions to disable security.
- This product cannot recognize the connected USB storage device.
 - Disconnect the device and replace it with another USB storage device.

Audio Format not supported

- This type of file is not supported on this product.
 - Select a file that can be played.

No Data

- There is no playable file in the USB storage device.
 - Check that the files in the USB storage device are compatible with this product.
- Security for the connected USB storage device is enabled.
 - Follow the USB storage device instructions to disable security.

USB Mirroring**Autolink can't connect right now. When it's safe to do so, check your Android phone.**

- The connection is not successfully established.
 - Stop your vehicle in a safe place and apply the parking brake. Perform the operations according to the following situations.
 - When the pop-up message appears on your mobile device, follow the message.
 - When the pop-up message does not appear on your mobile device, forcibly cancel download of the application, and then perform the connection with the unit again.

Mobile phone is standby, any touch wake up!

- The screen of the mobile device connected to the unit is turned off.
 - Unlock your mobile device.

Apple CarPlay**Connection failed.**

- Communication failed and the system is trying to connect.
- Wait for a while. Then, perform the actions below if the error message is still displayed.
 - Restart the iPhone.
 - Disconnect the cable from the iPhone, and then connect the iPhone again after a few seconds.
 - Turn the ignition switch to OFF and then to ON.

Please attach the GPS antenna in order to use Apple CarPlay over Wireless.

- This unit cannot properly detect the GPS signal from the GPS antenna.
 - Check the GPS antenna installation and connection. For details about the connection and installation, refer to the Installation Manual.

Android Auto

- **Connect a USB cable to get started.**
- **Your phone does not support wireless, check your phone.**
 - The connected device is not compatible with Android Auto.
 - Check if the device is compatible with Android Auto (page 36).
 - Android Auto app is not installed on the device.
 - Install the Android Auto app on the device.

Connection failed. Please check your phone to confirm connection.

- Wi-Fi connection failed and Android Auto app did not start.
 - Check if the Wi-Fi function on the device is turned on.

Android Auto has disconnected.

- Wi-Fi function on the device or the unit is turned off.
- Turn on the Wi-Fi function on the device and the unit when you use Android Auto (page 20).

To use Android Auto, please stop your car and follow the instructions on your phone

- The default settings are displayed on the screen of the Android Auto compatible device or images are not output from the Android Auto compatible device.
- Park your vehicle in a safe place, and follow the instructions displayed on the screen. If the error message is still displayed after performing on-screen instructions, please reconnect the device.

Camera View & AUX**No Video Signal**

- There is no video signal input.
- Confirm whether the connection with the unit is established and there is an output from the external device.

Bluetooth**Handsfree device is not connected**

- The phone's Bluetooth HFP is not connected and cannot make calls.
- Make a Bluetooth connection (page 14).

Phone book access is not authorized

- The Bluetooth PBAP of the mobile phone is not connected and the phone book cannot be downloaded.
- Make a PBAP connection. You need to operate your phone and allow the unit to access the contact information on

your phone. When the related information pops up on your phone, follow the pop-up message.

Others**Caution! USB Overcurrent**

- Overcurrent is detected.
- Check the USB connection. Perform one of the following operations to fix the situation.
 - Turn off the ignition switch (ACC OFF) and then turn the ignition switch to on (ACC ON) again.
 - Power the unit off and then power it on again.
 - Disconnect the (+) battery cable and then connect it again.

Caution! AMP Overload

- An amplifier overload is detected.
- Check the amp connection. Perform one of the following operations to fix the situation.
 - Turn off the ignition switch (ACC OFF). After 9 seconds or more, turn the ignition switch to on (ACC ON) again.
 - Disconnect the (+) battery cable and then connect it again.

Detailed information for playable media**Compatibility****Common notes about the USB storage device**

- Do not leave the USB storage device in any location with high temperatures.
- Depending on the kind of the USB storage device you use, this product may not recognize the storage device or files may not be played back properly.

- The text information of some audio and video files may not be correctly displayed.
- File extensions must be used properly.
- There may be a slight delay when starting playback of files on an USB storage device with complex folder hierarchies.
- Operations may vary depending on the kind of an USB storage device.
- It may not be possible to play some music files from USB because of file characteristics, file format, recorded application, playback environment, storage conditions, and so on.

USB storage device compatibility

- For details about USB storage device compatibility with this product, refer to Specifications (page 65).
- Protocol: bulk
- You cannot connect a USB storage device to this product via a USB hub.
- Partitioned USB storage device is not compatible with this product.
- Firmly secure the USB storage device when driving. Do not let the USB storage device fall onto the floor, where it may become jammed under the brake or gas pedal.
- There may be a slight delay when starting playback of audio files encoded with image data.
- Some USB storage devices connected to this product may generate noise on the radio.
- Do not connect anything other than the USB storage device.

The sequence of audio files on USB storage device.

For USB storage device, the sequence is different from that of USB storage device.

Handling guidelines and supplemental information

- Copyright protected files cannot be played back.

Media compatibility chart

General

- Maximum playback time of audio file stored on an USB storage device: 7.5 h (450 minutes)

USB storage device

CODEC FORMAT	MP3, WMA, WAV, AAC, FLAC, AVI, MPEG-PS, MP4, 3GP, MKV, MOV, ASF, FLV, M4V, MPEG-TS
--------------	--

MP3 compatibility

- Ver. 2.x of ID3 tag is prioritized when both Ver. 1.x and Ver. 2.x exist.
- This product is not compatible with the following: MP3i (MP3 interactive), mp3 PRO, m3u playlist

SAMPLING FREQUENCY	8 kHz to 48 kHz
TRANSMISSION RATE	CBR (8 kbps to 320 kbps)/VBR
ID3 TAG	ver.1.0/1.1/2.2/2.3/2.4

WMA compatibility

- This product is not compatible with the following: Windows Media™ Audio 9.2 Professional, Lossless, Voice

SAMPLING FREQUENCY	32 kHz to 48 kHz
TRANSMISSION RATE	CBR (8 kbps to 320 kbps)/VBR

WAV compatibility

- The sampling frequency shown in the display may be rounded.

SAMPLING FREQUENCY	16 kHz to 48 kHz
QUANTIZATION BIT RATE	8 bit, 16 bit

AAC compatibility

- This product plays back AAC files encoded by iTunes.

SAMPLING FREQUENCY	8 kHz to 48 kHz
TRANSMISSION RATE	CBR (16 kbps to 320 kbps)

FLAC compatibility

SAMPLING FREQUENCY	8 kHz to 192 kHz
QUANTIZATION BIT RATE	8 bit, 16 bit, 24 bit

USB storage device

EXTENSION	.avi
MAX RESOLUTION	720 × 576

Video files compatibility

- Files may not be played back properly depending on the environment in which the file was created or on the contents of the file.
- This product is not compatible with packet write data transfer.
- This product can recognize up to 32 characters, beginning with the first character, including extension for the file and folder name. Depending on the display area, this product may try to display them with a reduced font size. However, the maximum number of the characters that you can display varies according to the width of each character, and of the display area.
- Folder selection sequence or other operations may be altered, depending on the encoding or writing software.
- Regardless of the length of blank section between the songs of original recording, compressed audio files play with a short pause between songs.
- Files may not be able to be played back depending on the bit rate.
- The maximum resolution depends on the compatible video codec.

.avi

Compatible video codec	MPEG4, H.264
Maximum resolution	1 920 × 1 080
Maximum frame rate	30 fps

.mpg/.mpeg

Compatible video codec	MPEG2
Maximum resolution	720 × 576
Maximum frame rate	30 fps

.mp4

Compatible video codec	MPEG4, H.264
Maximum resolution	1 920 × 1 080
Maximum frame rate	30 fps

.3gp

Compatible video codec	H.264
Maximum resolution	1 920 × 1 080
Maximum frame rate	30 fps

.mkv

Compatible video codec	MPEG4, H.264, VC-1
Maximum resolution	1 920 × 1 080
Maximum frame rate	30 fps

.mov

Compatible video codec	MPEG4, H.264
Maximum resolution	1 920 × 1 080
Maximum frame rate	30 fps

.flv

Compatible video codec	H.264, H.263
Maximum resolution	1 920 × 1 080
Maximum frame rate	30 fps

.wmv/.asf

Compatible video codec	VC-1
Maximum resolution	1 920 × 1 080
Maximum frame rate	30 fps

.m4v

Compatible video codec	H.264
Maximum resolution	1 920 × 1 080
Maximum frame rate	30 fps

.ts

Compatible video codec	MPEG4, H.264, MPEG2
Maximum resolution	1 920 × 1 080
Maximum frame rate	30 fps

.m2ts

Compatible video codec	H.264, MPEG2
Maximum resolution	1 920 × 1 080
Maximum frame rate	30 fps

.mts

Compatible video codec	H.264
Maximum resolution	1 920 × 1 080
Maximum frame rate	30 fps

Example of a hierarchy**NOTE**

This product assigns folder numbers. The user cannot assign folder numbers.

Bluetooth

The *Bluetooth*® word mark and logos are registered trademarks owned by Bluetooth SIG, Inc. and any use of such marks by Pioneer Corporation is under license. Other trademarks and trade names are those of their respective owners.

SiriusXM Satellite Radio

SiriusXM and all related marks and logos are trademarks of Sirius XM Radio, Inc. All rights reserved.

Wi-Fi

Wi-Fi® is a registered trademark of Wi-Fi Alliance®.



The Wi-Fi CERTIFIED™ Logo is a registered trademark of Wi-Fi Alliance®.

WMA

Windows Media is either a registered trademark or trademark of Microsoft Corporation in the United States and/or other countries.

- This product includes technology owned by Microsoft Corporation and cannot be used or distributed without a license from Microsoft Licensing, Inc.

FLAC

Copyright © 2000-2009 Josh Coalson
Copyright © 2011-2013 Xiph.Org
Foundation

Redistribution and use in source and binary forms, with or without modification, are permitted provided that the following conditions are met:

- Redistributions of source code must retain the above copyright notice, this list of conditions and the following disclaimer.
- Redistributions in binary form must reproduce the above copyright notice, this list of conditions and the following disclaimer in the documentation and/or other materials provided with the distribution.
- Neither the name of the Xiph.org Foundation nor the names of its contributors may be used to endorse or promote products derived from this software without specific prior written permission.

THIS SOFTWARE IS PROVIDED BY THE COPYRIGHT HOLDERS AND CONTRIBUTORS "AS IS" AND ANY EXPRESS OR IMPLIED WARRANTIES, INCLUDING, BUT NOT LIMITED TO, THE IMPLIED WARRANTIES OF MERCHANTABILITY AND FITNESS FOR A PARTICULAR PURPOSE ARE DISCLAIMED. IN NO EVENT SHALL THE FOUNDATION OR CONTRIBUTORS BE LIABLE FOR ANY DIRECT, INDIRECT, INCIDENTAL, SPECIAL, EXEMPLARY, OR CONSEQUENTIAL DAMAGES (INCLUDING, BUT NOT LIMITED TO, PROCUREMENT OF SUBSTITUTE GOODS OR SERVICES; LOSS OF USE, DATA, OR PROFITS; OR BUSINESS INTERRUPTION) HOWEVER CAUSED AND ON ANY THEORY OF LIABILITY, WHETHER IN CONTRACT, STRICT LIABILITY, OR TORT (INCLUDING NEGLIGENCE OR OTHERWISE) ARISING IN ANY WAY OUT OF THE USE OF

THIS SOFTWARE, EVEN IF ADVISED OF THE POSSIBILITY OF SUCH DAMAGE.

AAC

AAC is short for Advanced Audio Coding and refers to an audio compression technology standard used with MPEG-2 and MPEG-4. Several applications can be used to encode AAC files, but file formats and extensions differ depending on the application which is used to encode. This unit plays back AAC files encoded by iTunes.

WebLink

WebLink™ is a trademark of Abalta Technologies, Inc.

Google, Android, Google Play

Google, Android and Google Play are trademarks of Google LLC.

Android Auto

androidauto

Android Auto is a trademark of Google LLC.

Detailed information regarding connected iPhone devices

- Pioneer accepts no responsibility for data lost from an iPhone, even if that data is

lost while using this product. Please back up your iPhone data regularly.

- Do not leave the iPhone in direct sunlight for extended amounts of time. Extended exposure to direct sunlight can result in iPhone malfunction due to the resulting high temperature.
- Do not leave the iPhone in any location with high temperatures.
- Firmly secure the iPhone when driving. Do not let the iPhone fall onto the floor, where it may become jammed under the brake or gas pedal.
- For details, refer to the iPhone manuals.

iPhone, Siri, and Lightning



Use of the Made for Apple badge means that an accessory has been designed to connect specifically to the Apple product(s) identified in the badge and has been certified by the developer to meet Apple performance standards.

Apple is not responsible for the operation of this device or its compliance with safety and regulatory standards.

Please note that the use of this accessory with an Apple product may affect wireless performance.

Apple, the Apple logo, iPhone, Siri, and Lightning are trademarks of Apple Inc., registered in the U.S. and other countries.

Works with Siri through the microphone.

App Store

App Store is a service mark of Apple Inc., registered in the U.S. and other countries.

iOS

iOS is a trademark or registered trademark of Cisco in the U.S. and other countries and is used under license.

iTunes

iTunes is a trademark of Apple Inc., registered in the U.S. and other countries.

Apple Music

Apple Music is a trademark of Apple Inc., registered in the U.S. and other countries.

Apple CarPlay



Apple CarPlay is a trademark of Apple Inc.

Use of the Apple CarPlay logo means that a vehicle user interface meets Apple performance standards. Apple is not responsible for the operation of this vehicle or its compliance with safety and regulatory standards. Please note that the use of this product with iPhone or iPod may affect wireless performance.

Compatible iPhone models

- iPhone 12 Pro Max
- iPhone 12 Pro
- iPhone 12
- iPhone 12 mini
- iPhone SE (2nd generation)
- iPhone 11 Pro Max
- iPhone 11 Pro
- iPhone 11
- iPhone XR
- iPhone XS Max
- iPhone XS
- iPhone X
- iPhone 8
- iPhone 8 Plus
- iPhone 7
- iPhone 7 Plus
- iPhone SE (1st generation)
- iPhone 6s
- iPhone 6s Plus
- iPhone 6
- iPhone 6 Plus
- iPhone 5s

Depending on the iPhone models, it may not be compatible with some AV sources. For details about iPhone compatibility with this product, refer to the information on our website.

Using app-based connected content

Important

Requirements to access app-based connected content services using this product:

- Latest version of the Pioneer compatible connected content application(s) for the smartphone, available from the service provider, downloaded to your smartphone.
- A current account with the content service provider.

- Smartphone Data Plan.
Note: if the Data Plan for your smartphone does not provide for unlimited data usage, additional charges from your carrier may apply for accessing app-based connected content via 3G, EDGE and/or LTE (4G) networks.
- Connection to the Internet via 3G, EDGE, LTE (4G) or Wi-Fi network.
- Optional Pioneer adapter cable connecting your iPhone to this product.

Limitations:

- Access to app-based connected content will depend on the availability of cellular and/or Wi-Fi network coverage for the purpose of allowing your smartphone to connect to the Internet.
- Service availability may be geographically limited to the region. Consult the connected content service provider for additional information.
- Ability of this product to access connected content is subject to change without notice and could be affected by any of the following: compatibility issues with future firmware versions of smartphone; compatibility issues with future versions of the connected content application(s) for the smartphone; changes to or discontinuation of the connected Content application(s) or service by its provider.
- Pioneer is not liable for any issues that may arise from incorrect or flawed app-based content.
- The content and functionality of the supported applications are the responsibility of the App providers.
- In USB Mirroring, WebLink, Apple CarPlay and Android Auto, functionality through the product is limited while driving, with available functions determined by the App providers.
- Availability of USB Mirroring, WebLink, Apple CarPlay and Android Auto

functionalities is determined by the App provider, and not determined by Pioneer.

- USB Mirroring, WebLink, Apple CarPlay and Android Auto allow access to applications other than those listed (subject to limitations while driving), but the extent to which content can be used is determined by the App providers.

Notice regarding video viewing

Remember that use of this system for commercial or public viewing purposes may constitute an infringement on the author's rights as protected by the Copyright Law.

Using the LCD screen correctly

Handling the LCD screen

- When the LCD screen is subjected to direct sunlight for a long period of time, it will become very hot, resulting in possible damage to the LCD screen. When not using this product, avoid exposing it to direct sunlight as much as possible.
- The LCD screen should be used within the temperature ranges shown in Specifications on page 65.
- Do not use the LCD screen at temperatures higher or lower than the operating temperature range, because the LCD screen may not operate normally and could be damaged.
- The LCD screen is exposed in order to increase its visibility within the vehicle. Please do not press strongly on it as this may damage it.

- Do not push the LCD screen with excessive force as this may scratch it.
- Never touch the LCD screen with anything besides your finger when operating the touch panel functions. The LCD screen can scratch easily.

Liquid crystal display (LCD) screen

- If the LCD screen is near the vent of an air conditioner, make sure that air from the air conditioner is not blowing on it. Heat from the heater may break the LCD screen, and cool air from the cooler may cause moisture to form inside this product, resulting in possible damage.
- Small black dots or white dots (bright dots) may appear on the LCD screen. These are due to the characteristics of the LCD screen and do not indicate a malfunction.
- The LCD screen will be difficult to see if it is exposed to direct sunlight.
- When using a cellular phone, keep the antenna of the cellular phone away from the LCD screen to prevent disruption of the video in the form of disturbances such as spots or colored stripes.

Maintaining the LCD screen

- When removing dust from or cleaning the LCD screen, first turn this product off and then wipe the screen with a soft dry cloth.
- When wiping the LCD screen, take care not to scratch the surface. Do not use harsh or abrasive chemical cleaners.

LED (light-emitting diode) backlight

A light emitting diode is used inside the display to illuminate the LCD screen.

- At low temperatures, using the LED backlight may increase image lag and degrade the image quality because of the characteristics of the LCD screen. Image quality will improve with an increase in temperature.
- The product lifetime of the LED backlight is more than 10 000 hours. However, it may decrease if used in high temperatures.
- If the LED backlight reaches the end of its product lifetime, the screen will become dimmer and the image will no longer be visible. In that case, please consult your dealer or the nearest authorized Pioneer Service Station.

Specifications

General

Rated power source:

14.4 V DC (10.8 V to 15.1 V allowable)

Grounding system:

Negative type

Maximum current consumption:

10.0 A

Dimensions (W × H × D):

Chassis (D):

178 mm × 100 mm × 125 mm (7 in. × 3-7/8 in. × 4-7/8 in.)

Nose:

171 mm × 97 mm × 2 mm (6-3/4 in. × 3-7/8 in. × 1/8 in.)

Weight:

1.1 kg (2.4 lbs)

Display

Screen size/aspect ratio:

6.75 inch wide/16:9 (effective display area: 151.8 mm × 79.68 mm) (6 in. × 3-1/8 in.)

Pixels:

800 (Width) × 480 (Height) × 3 (RGB)

Display method:

TFT Active matrix driving

Color system:

PAL/NTSC/PAL-M/PAL-N/SECAM compatible

Temperature range:

-10 °C to +60 °C (+14 °F to +140 °F)

Audio

Maximum power output:

50 W × 4

Continuous power output:

22 W × 4 (50 Hz to 15 kHz, 5 %THD, 4 Ω LOAD, Both Channels Driven)

Load impedance:

4 Ω (4 Ω to 8 Ω allowable)

Preout output level (max): 2.0 V

Equalizer (13-Band Graphic Equalizer):

Frequency:

50 Hz/80 Hz/125 Hz/200 Hz/315 Hz/

500 Hz/800 Hz/1.25 kHz/2 kHz/3.15

kHz/5 kHz/8 kHz/12.5 kHz

Gain: ±12 dB (2 dB/step)

HPF:

Frequency:

25 Hz/32 Hz/40 Hz/50 Hz/63 Hz/80 Hz/

100 Hz/125 Hz/160 Hz/200 Hz/250 Hz

Subwoofer/LPF:

Frequency:

25 Hz/32 Hz/40 Hz/50 Hz/63 Hz/80 Hz/

100 Hz/125 Hz/160 Hz/200 Hz/250 Hz

Bass boost:

Gain: +12 dB to 0 dB (2 dB/step)

Speaker level:

+10 dB to -24 dB (1 dB/step)

USB

USB standard spec:

USB 1.1, USB 2.0 full speed, USB 2.0 high speed

Max current supply: 1.5 A

USB Class:

MSC (Mass Storage Class)

File system: FAT16, FAT32, NTFS

<USB audio>

MP3 decoding format:

MPEG-1 & 2 & 2.5 Audio Layer 3

WMA decoding format:

Ver. 7, 8, 9, 9.1, 9.2 (2 ch audio)

AAC decoding format:

MPEG-4 AAC (iTunes encoded only) (Ver. 12.5 and earlier)

FLAC decoding format:

Ver. 1.3.0 (Free Lossless Audio Codec)

WAV signal format:

Linear PCM

Sampling frequency:

Linear PCM:

16 kHz/22.05 kHz/24 kHz/32 kHz/44.1 kHz/48 kHz

<USB image>

JPEG decoding format:

.jpeg, .jpg

Pixel Sampling: 4:2:2, 4:2:0

Decode Size:

MAX: 5 000 (H) × 5 000 (W)

MIN: 32 (H) × 32 (W)

(Maximum file size: 6 MB)

PNG decoding format:

.png

Decode Size:

MAX: 576 (H) × 720 (W)

MIN: 32 (H) × 32 (W)

BMP decoding format:

.bmp

Decode Size:

MAX: 936 (H) × 1 920 (W)

MIN: 32 (H) × 32 (W)

<USB video>

H.264 video decoding format:

Base Line Profile, Main Profile, High Profile

H.263 video decoding format:

Base Line Profile 0/3

VC-1 video decoding format:

Simple Profile, Main Profile, Advanced Profile

AVI video decoding format**MPEG4 video decoding format:**

Simple Profile, Advanced Simple Profile

MPEG1, 2 video decoding format:

Main Profile

Quick Time video decoding format**Matroska video decoding format****TS Stream video decoding format****Bluetooth****Version:**

Bluetooth 4.2 certified

Output power:

+4 dBm Max. (Power class 2)

Frequency band(s):

2 402.0 MHz to 2 480.0 MHz

FM tuner**Frequency range:**

87.9 MHz to 107.9 MHz

Usable sensitivity:

13 dBf (1.1 μ V/75 Ω , mono, S/N: 30 dB)

Signal-to-noise ratio:

50 dB (analog broadcasting) (IHF-A network)

AM tuner**Frequency range:**

530 kHz to 1 710 kHz

Usable sensitivity:

28 μ V (S/N: 20 dB)

Signal-to-noise ratio:

45 dB (analog broadcasting) (IHF-A network)

Wi-Fi**Frequency channel:**

151 ch (5 GHz)

Security:

WPA2 (Personal), WPA3 (Personal)

Output power:

+13.2 dBm Max (5 GHz)

GPS**GNSS receiver****System:**

GPS L1C/Ac, SBAS L1C/A, GLONASS L1OF, Galileo E1B/C
SPS (Standard Positioning Service)

Reception system:

64 channel Multi-channel reception system

Reception frequency:

1 575.42 MHz/1 602 MHz

Sensitivity:

-140 dBm (typ)

Frequency:

Approx. once per second

GPS antenna

Antenna:

Micro strip flat antenna/right-handed
helical polarization

Antenna cable:

3.55 m (11ft. 7in.)

Dimensions (W × H × D):

47 mm × 16.2 mm × 55 mm (1-7/8 in. ×
5/8 in. × 2-1/8 in.)

Weight:

104.0 g (0.2 lbs)

CTA2006 Specifications



Power output:

14 W RMS × 4 Channels (4 Ω and $\leq 1\%$
THD+N)

S/N ratio:

91 dBA (reference: 1 W into 4 Ω)

NOTE

Specifications and design are subject to possible modifications without notice due to improvements.

Register your product at

<https://www.pioneerelectronics.com/PUSA/>

in Canada **<https://www.pioneerelectronics.ca/POCEN/>**

PIONEER CORPORATION

28-8, Honkomagome 2-chome, Bunkyo-ku,
Tokyo 113-0021, Japan

PIONEER ELECTRONICS (USA) INC.

P.O. Box 1540, Long Beach, CA 90801-1540, U.S.A.
TEL: (800) 421-1404

PIONEER EUROPE NV

Haven 1087, Keetberglaan 1, B-9120 Melsele, Belgium/Belgique
TEL: (0) 3/570.05.11

PIONEER ELECTRONICS ASIACENTRE PTE. LTD.

No. 2 Jalan Kilang Barat, #04-02, Singapore 159346
TEL: 65-6378-7888

PIONEER ELECTRONICS AUSTRALIA PTY. LTD.

Unit 13, 153-155 Rooks Road, Vermont, Victoria, 3133 Australia
TEL: (03) 9586-6300

PIONEER ELECTRONICS DE MÉXICO S.A. DE C.V.

Bld. Manuel Ávila Camacho #118, Piso 12, Lomas de Chapultepec,
Alcaldía Miguel Hidalgo C.P. 11000, Ciudad de México
Tel: 52-55-9178-4270

先鋒股份有限公司

台北市內湖區瑞光路407號8樓
電話：886-(0) 2-2657-3588

先鋒電子（香港）有限公司

香港九龍長沙灣道909號5樓
電話：852-2848-6488

Pioneer

DMH-W2770NEX

DMH-W2700NEX

RDS AV RECEIVER

RÉCEPTEUR AV AVEC RDS

RECEPTOR AV RDS

Installation Manual
Manuel d'installation
Manual de instalación

English

Français

Español

Important safety information

WARNING

Rear visibility systems (backup cameras) are required in certain new vehicles sold in the U.S. and Canada. U.S. regulations began according to a two year phase-in on May 1, 2016, and both the U.S. and Canada require that all such vehicles manufactured on or after May 1, 2018 have rear visibility systems. **Owners of vehicles equipped with compliant rear visibility systems should not install or use this product in a way that alters or disables that system's compliance with applicable regulations.** If you are unsure whether your vehicle has a rear visibility system subject to the U.S. or Canadian regulations, please contact the vehicle manufacturer or dealer.

If your vehicle has a compliant backup camera that displays the backup view through the factory receiver, do not use the Pioneer receiver unless it is connected to and displays the same view as the factory backup camera. Connection to the factory backup camera will require an adaptor, sold separately. Not all vehicles may be able to connect. Please check with a qualified professional installer for installation options specific to your vehicle.

Checking supplied items

This product/ connection cables/ installation parts/ Remote Control

- This product (x1)
- Power cord (x1)
- Pre out cord (x1)
- SWC/Back Camera cord (x1)
- AUX IN cord (x1)
- USB cable (x1)
- SiriusXM® cable (x1)
- Flush surface screw (x6)
- Truss head screw (x6)
- Remote Control (x1) (DMH-W2770NEX)

NOTE

SiriusXM and all related marks and logos are trademarks of Sirius XM Radio, Inc. All rights reserved.

GPS antenna/ installation parts

- GPS antenna (x1)
- Double-sided tape (x1)
- Clamps (x3)

Microphone/ installation parts

- Microphone (x1)
- Double-sided tape (x1)

Other items

- Manual(s) (x1)
- Warranty Card (x1)

Connection

Precautions

Your new product and this manual

- Do not operate this product, any

applications, or the rear view camera option (if purchased) if doing so will divert your attention in any way from the safe operation of your vehicle. Always observe safe driving rules and follow all existing traffic regulations. If you experience difficulty in operating this product, pull over, park your vehicle in a safe location and apply the parking brake

before making the necessary adjustments.

- Do not install this product where it may (i) obstruct the driver's vision, (ii) impair the performance of any of the vehicle's operating systems of safety features, including airbags, hazard lamp buttons, or (iii) impair the driver's ability to safely operate the vehicle. In some cases, it may not be possible to install this product because of the vehicle type or the shape of the vehicle interior.

Important safeguards

WARNING

Pioneer does not recommend that you install this product yourself. This product is designed for professional installation only. We recommend that only authorized Pioneer service personnel, who have special training and experience in mobile electronics, set up and install this product. NEVER SERVICE THIS PRODUCT YOURSELF. Installing or servicing this product and its connecting cables may expose you to the risk of electric shock or other hazards, and can cause damage to this product that is not covered by warranty.

Precautions before connecting the system

WARNING

Do not take any steps to tamper with or disable the parking brake interlock system which is in place for your protection. Tampering with or disabling the parking brake interlock system could result in serious injury or death.

CAUTION

- Secure all wiring with cable clamps or electrical tape. Do not allow any bare wiring to remain exposed.
- Do not directly connect the yellow lead of this product to the vehicle battery. If the lead is directly connected to the battery, engine vibration may eventually cause the insulation to fail at the point where the wire passes from the passenger compartment into the engine compartment. If the yellow lead's insulation tears as a result of contact with metal parts, short-circuiting can occur, resulting in considerable danger.
- It is extremely dangerous to allow cables to become wound around the steering column or shift lever. Be sure to install this product, its cables, and wiring away in such so that they will not obstruct or hinder driving.
- Make sure that the cables and wires will not interfere with or become caught in any of the vehicle's moving parts, especially the steering wheel, shift lever, parking brake, sliding seat tracks, doors, or any of the vehicle's controls.
- Do not route wires where they will be exposed to high temperatures. If the insulation heats up, wires may become damaged, resulting in a short circuit or malfunction and permanent damage to the product.
- Do not shorten any leads. If you do, the protection circuit (fuse holder, fuse resistor or filter, etc.) may fail to work properly.
- Never feed power to other electronic products by cutting the insulation of the power supply lead of this product and tapping into the lead. The current capacity of the lead will be exceeded, causing overheating.

Before installing this product

- Use this unit with a 12-volt battery and negative grounding only. Failure to do so may result in a fire or malfunction.
- To avoid shorts in the electrical system, be sure to disconnect the (-) battery system before installation.

To prevent damage

WARNING

- When speaker output is used by 4 channels, use speakers over 50 W (Maximum input power) and between 4 Ω to 8 Ω (impedance value). Do not use 1 Ω to 3 Ω speakers for this unit.
- The black cable is ground. When installing this unit or power amp (sold separately), make sure to connect the ground wire first. Ensure that the ground wire is properly connected to metal parts of the car's body. The ground wire of the power amp and the one of this unit or any other device must be connected to the car separately with different screws. If the screw for the ground wire loosens or falls out, it could result in fire generation of smoke or malfunction.

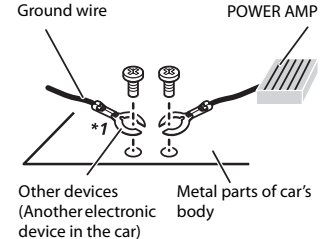

*1 Non supplied for this unit

- When replacing the fuse, be sure to only use a fuse of the rating prescribed on this product.
- This product cannot be installed in a vehicle without ACC (accessory) position on the ignition switch.



ACC position



No ACC position

- To avoid short-circuiting, cover the disconnected lead with insulating tape. It is especially important to insulate all unused speaker leads, which if left uncovered may cause a short circuit.
- For connecting a power amp or other devices to this product, refer to the manual for the product to be connected.
- The graphical symbol  placed on the product means direct current.

Notice for the blue/white lead

- When the ignition switch is turned on (ACC ON), a control signal is output through the blue/white lead. Connect to

an external power amp's system remote control terminal, the auto-antenna relay control terminal, or the antenna booster power control terminal (max. 300 mA 12 V DC). The control signal is output through the blue/white lead, even if the audio source is switched off.

This product

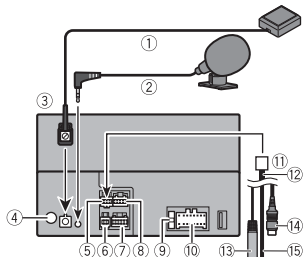

- ① GPS antenna 3.55 m (11 ft. 8 in.)
- ② Microphone 3 m (9 ft. 10-1/8 in.)
- ③ This product
- ④ Antenna jack
- ⑤ Connector 1 (**REAR VIEW CAMERA IN/ MUTE/STEERING WHEEL CONTROL**)
- ⑥ Connector 2 (**AUX IN**)
- ⑦ Pre out supply
- ⑧ SiriusXM Connect Vehicle Tuner
Be sure to use the SiriusXM cable supplied with this product. Refer to the installation guide for SiriusXM Connect Vehicle Tuner (sold separately).
- ⑨ Fuse (10 A)
- ⑩ Power supply
- ⑪ To connector 1
- ⑫ SWC/Back Camera cord
- ⑬ Wired remote input (**STEERING WHEEL CONTROL**)
Hard-wired remote control adapter can be connected (sold separately).

- ⑭ Brown (**REAR VIEW CAMERA IN**)
- ⑮ Yellow/black (**MUTE**)

Power cord

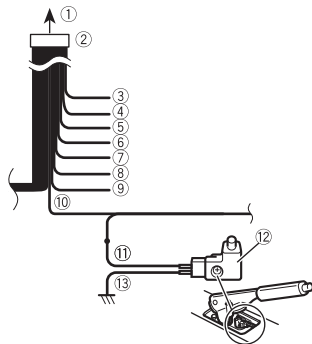

- ① To power supply
- ② Power cord
- ③ Yellow
To terminal supplied with power regardless of ignition switch position.
- ④ Red
To electric terminal controlled by ignition switch (12 V DC) ON/OFF
- ⑤ Orange/white
To lighting switch terminal.
- ⑥ Black (ground)
To vehicle (metal) body.
- ⑦ Violet/white
Of the two lead wires connected to the back lamp, connect the one in which the voltage changes when the gear shift is in the REVERSE (R) position. This connection enables the unit to sense whether the car is moving forward or backward.
- ⑧ Pink
Car speed signal input
- ⑨ Blue/white

- ⑩ Light green
Used to detect the ON/OFF status of the parking brake. This lead must be connected to the power supply side of the parking brake switch.

- ⑪ Power supply side
- ⑫ Parking brake switch
- ⑬ Ground side

NOTE

The position of the speed detection circuit and the position of the parking brake switch vary depending on the vehicle model. For details, consult your authorized Pioneer dealer or an installation professional.

- ⑩ Gray/black
- ⑪ Green
- ⑫ Green/black
- ⑬ Violet
- ⑭ Violet/black

NOTE

With a two-speaker system, do not connect anything to the speaker leads that are not connected to speakers.

Speaker leads

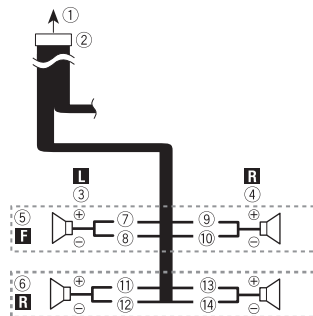

- ① To power supply
- ② Power cord
- ③ Left
- ④ Right
- ⑤ Front speaker
- ⑥ Rear speaker
- ⑦ White
- ⑧ White/black
- ⑨ Gray

Power amp (sold separately)

Important

The speaker leads are not used when this connection is in use.

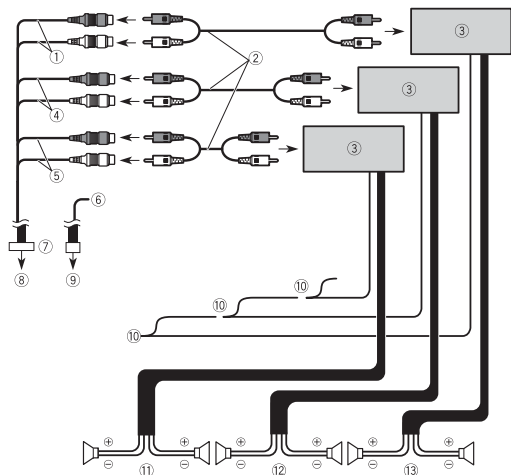

- ① Subwoofer output (**SUBWOOFER OUT L/SUBWOOFER OUT R**)
- ② RCA cable (sold separately)
- ③ Power amp
- ④ Front output (**FRONT OUT L/FRONT OUT R**)
- ⑤ Rear output (**REAR OUT L/REAR OUT R**)
- ⑥ Yellow/black (**MUTE**)

If you use an equipment with Mute function, wire this lead to the Audio Mute lead on that equipment. If not, keep the Audio Mute lead free of any connections.

- ⑦ Pre out cord
- ⑧ To pre out supply
- ⑨ To connector 1
- ⑩ System remote control
Connect to Blue/white cable.
- ⑪ Rear speaker
- ⑫ Front speaker
- ⑬ Subwoofer

iPhone and smartphone

NOTES

- For details on how to connect an external device using a separately sold cable, refer to the manual for the cable.
- For details concerning the connection and operations of iPhone or smartphone, refer to the Operation Manual.
- iPhone and Lightning are trademarks of Apple Inc., registered in the U.S. and other countries.

iPhone with Lightning connector

Connecting via the USB port

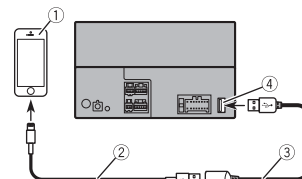

- ① iPhone with Lightning connector
- ② USB interface cable for iPhone (sold separately)
- ③ USB cable 1.5 m (4 ft. 11 in.)
- ④ USB port

Smartphone (Android™ device)

Connecting via the USB port

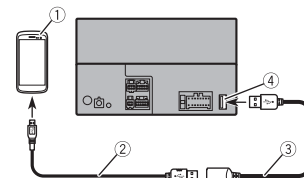

- ① Smartphone
- ② USB - micro USB cable (USB Type-A to micro USB Type-B) (sold separately)
USB Type-C® cable (USB Type-A to USB Type-C) (sold separately)
- ③ USB cable 1.5 m (4 ft. 11 in.)
- ④ USB port

NOTES

- Due to the USB standard, the total length when a USB Type-A to micro USB Type-B cable (②) and a USB cable (③) are connected cannot exceed 2 m (6 ft. 6 in.), and when a USB Type-A to USB Type-C cable (②) and a USB cable (③) are connected cannot exceed 4 m (13 ft. 1 in.). If you use a cable other than the above conditions, the main unit function may not operate properly.
- Android is a trademark of Google LLC.
- USB Type-C® and USB-C® are registered trademarks of USB Implementers Forum.

Camera

About rear view camera

When you use the rear view camera, the rear view image is automatically switched

from the video by moving the shift lever to **REVERSE (R)**. **Camera View** mode also allows you to check what is behind you while driving.

⚠ WARNING

USE INPUT ONLY FOR REVERSE OR MIRROR IMAGE REAR VIEW CAMERA. OTHER USE MAY RESULT IN INJURY OR DAMAGE.

⚠ CAUTION

- The screen image may appear reversed.
- With the rear view camera you can keep an eye on trailers, or back into a tight parking spot. Do not use for entertainment purposes.
- Objects in rear view may appear closer or more distant than in reality.
- The image area of full-screen images displayed while backing or checking the rear of the vehicle may differ slightly.

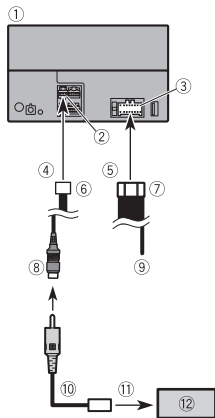

- ① This product
- ② Connector 1
- ③ Power supply
- ④ To connector 1

- ⑤ To power supply
- ⑥ SWC/Back Camera cord
- ⑦ Power cord
- ⑧ Brown (**REAR VIEW CAMERA IN**)
- ⑨ Violet/white (**REVERSE-GEAR SIGNAL INPUT**)

Refer to Power cord on page 4.

- ⑩ RCA cable (sold separately)
- ⑪ To video output
- ⑫ Rear view camera (sold separately)

NOTES

- Connect only the rear view camera to **REAR VIEW CAMERA IN**. Do not connect any other equipment.
- Some appropriate settings are required to use rear view cameras. For details, refer to the Operation Manual.

External video component and the display

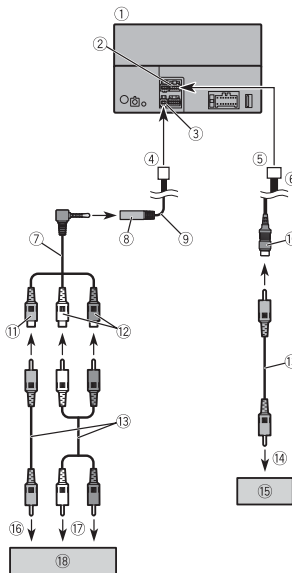

- ① This product
- ② Pre out supply
- ③ Connector 2
- ④ To connector 2
- ⑤ To pre out supply
- ⑥ Pre out cord
- ⑦ Mini-jack AV cable (sold separately)
- ⑧ AUX input (**AUX IN**)
- ⑨ AUX IN cord
- ⑩ Yellow (**REAR MONITOR OUT**)
- ⑪ Yellow
- ⑫ Red, white

- ⑬ RCA cables (sold separately)
- ⑭ To video input
- ⑮ Rear display with RCA input jacks
- ⑯ To video output
- ⑰ To audio outputs
- ⑱ External video component (sold separately)

⚠ WARNING

NEVER install the rear display in a location that enables the driver to watch the video source while driving.

This product's rear video output is for connection of a display to enable passengers in the rear seats to watch the video source.

⚠ CAUTION

Be sure to use a mini-jack AV cable (sold separately) for wiring. If you use other cables, the wiring position might differ resulting in disturbed images and sounds.

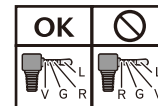

- L : Left audio (White)
- R : Right audio (Red)
- V : Video (Yellow)
- G : Ground

Installation

Precautions before installation

⚠ CAUTION

- Never install this product in places where, or in a manner that:
 - Could injure the driver or passengers if the vehicle stops suddenly.
 - May interfere with the driver's operation of the vehicle, such as on the floor in front of the driver's seat, or close to the steering wheel or shift lever.
- To ensure proper installation, be sure to use the supplied parts in the manner specified. If any parts are not supplied with this product, use compatible parts in the manner specified after you have the part compatibility checked by your dealer. If parts other than supplied or compatible ones are used, they may damage internal parts of this product or they may work loose and the product may become detached.
- Do not install this product where it may
 - (i) obstruct the driver's vision,
 - (ii) impair the performance of any of the vehicle's operating systems or safety features, including airbags, hazard lamp buttons or
 - (iii) impair the driver's ability to safely operate the vehicle.
- Never install this product in front of or next to the place in the dashboard, door, or pillar from which one of your vehicle's airbags would deploy. Please refer to your vehicle's owner's manual for reference to the deployment area of the frontal airbags.

Before installing

- Consult with your nearest dealer if installation requires drilling holes or other modifications of the vehicle.
- Before making a final installation of this product, temporarily connect the wiring to confirm that the connections are correct and the system works properly.

Installation notes

- Do not install this product in places subject to high temperatures or humidity, such as:
 - Places close to a heater, vent or air conditioner.
 - Places exposed to direct sunlight, such as on top of the dashboard.
 - Places that may be exposed to rain, such as close to the door or on the vehicle's floor.
- Install this product horizontally on a surface within 0 to 60 degrees tolerance.

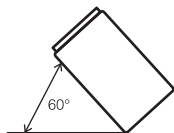

- When installing, to ensure proper heat dispersal when using this unit, make sure you leave ample space behind the rear panel and wrap any loose cables so they are not blocking the vents.

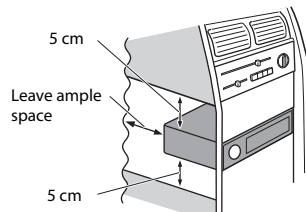

Installation using the screw holes on the side of this product

- Fastening this product to the factory radio-mounting bracket.**
Position this product so that its screw holes are aligned with the screw holes of the bracket, and tighten the screws at three locations on each side. Use either the truss head screws (5 mm × 9 mm) or flush surface screws (5 mm × 9 mm), depending on the shape of the bracket's screw holes.

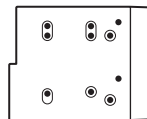

TIP

The amount of this unit's protrusion from the dashboard/console can be adjusted by shifting the position of the screw hole of this unit to the factory radio-mounting bracket.

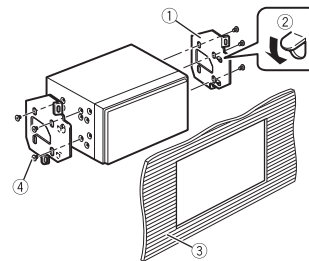

- Factory radio-mounting bracket
- If the pawl interferes with installation, you may bend it down out of the way.
- Dashboard or console
- Truss head screw or flush surface screw
Be sure to use the screws supplied with this product.

Installing the GPS antenna

⚠ CAUTION

Do not cut the GPS antenna lead to shorten it or use an extension to make it longer. Altering the antenna cable could result in a short circuit or malfunction and permanent damage to this product.

Installation notes

- The antenna should be installed on a level surface where radio waves will be blocked as little as possible. Radio waves cannot be received by the antenna if reception from the satellite is blocked.

When installing the antenna inside the vehicle (on the dashboard or rear shelf)

⚠ WARNING

Do not install the GPS antenna over any sensors or vents on the dashboard of the vehicle, as doing so may interfere with the proper functioning of such sensors or vents and may compromise the ability of the GPS antenna to properly and securely affix to the dashboard.

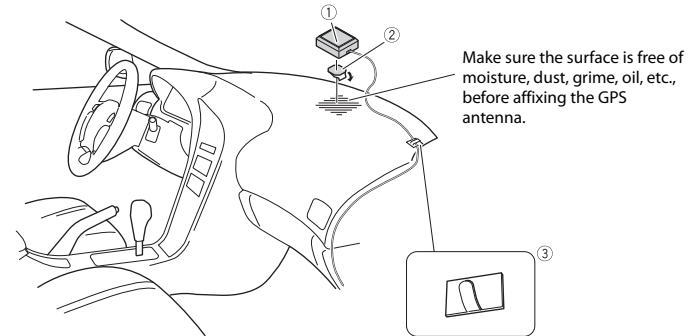

- ① GPS antenna
- ② Double-sided tape
- ③ Clamps

Use clamps to secure the lead where necessary inside the vehicle.

NOTES

- Affix the GPS antenna on the surface as level as possible where the GPS antenna faces the window.
- Some models use window glass that does not allow signals from GPS satellites to pass through. On such models, install the GPS antenna on the outside of the vehicle.

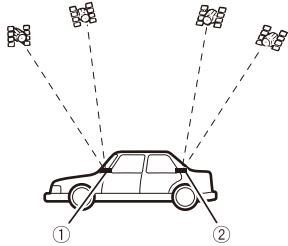

- ① Dashboard
- ② Rear shelf

- Take care not to pull the antenna lead when removing the GPS antenna. The lead may become detached.
- Do not paint the GPS antenna, as this may affect its performance.

Installing the microphone

- Install the microphone in a place where its direction and distance from the driver make it easiest to pick up the driver's voice.
- Be sure to turn off (ACC OFF) the product before connecting the microphone.
- Depending on the vehicle model, the microphone cable length may be too short when you mount the microphone on the sun visor. In such cases, install the microphone on the steering column.

Mounting on the sun visor

- 1 Fit the microphone lead into the groove.

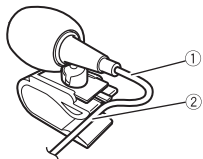

- 1 Microphone lead
- 2 Groove

- 2 Attach the microphone clip to the sun visor.

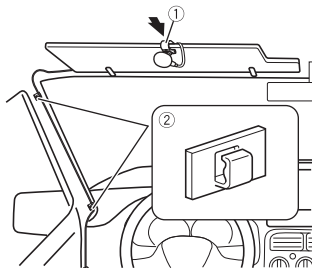

- 1 Microphone clip
- 2 Clamps

Use separately sold clamps to secure the lead where necessary inside the vehicle.

Install the microphone on the sun visor when it is in the up position. It cannot recognise the driver's voice if the sun visor is in the down position.

Installation on the steering column

- 1 Detach the microphone base from the microphone clip by sliding the microphone base while pressing the tab.

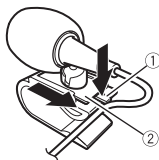

- 1 Tab
- 2 Microphone base

- 2 Mount the microphone on the steering column.

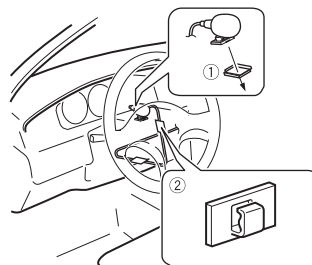

- 1 Double-sided tape
- 2 Clamps

Use separately sold clamps to secure the lead where necessary inside the vehicle.

NOTE

Install the microphone on the steering column, keeping it away from the steering wheel.

Adjusting the microphone angle

The microphone angle can be adjusted.



PIONEER CORPORATION

28-8, Honkomagome 2-chome, Bunkyo-ku,
Tokyo 113-0021, Japan

PIONEER ELECTRONICS (USA) INC.

P.O. Box 1540, Long Beach, CA 90801-1540, U.S.A.
TEL: (800) 421-1404

PIONEER EUROPE NV

Haven 1087, Keetberglaan 1, B-9120 Melsele, Belgium/Belgique
TEL: (0) 3/570.05.11

PIONEER ELECTRONICS ASIACENTRE PTE. LTD.

No. 2 Jalan Kilang Barat, #04-02, Singapore 159346
TEL: 65-6378-7888

PIONEER ELECTRONICS AUSTRALIA PTY. LTD.

Unit 13, 153-155 Rooks Road, Vermont, Victoria, 3133 Australia
TEL: (03) 9586-6300

PIONEER ELECTRONICS DE MÉXICO S.A. DE C.V.

Blvd. Manuel Ávila Camacho #118, Piso 12, Lomas de Chapultepec,
Alcaldía Miguel Hidalgo C.P. 11000, Ciudad de México
Tel: 52-55-9178-4270

先鋒股份有限公司

台北市內湖區瑞光路407號8樓
電話：886-(0)2-2657-3588

先鋒電子（香港）有限公司

香港九龍長沙灣道909號5樓
電話：852-2848-6488

Pioneer

RDS AV RECEIVER
RÉCEPTEUR AV AVEC RDS
RECEPTOR AV RDS

DMH-W2770NEX

DMH-W2700NEX

Quick start guide
Guide de démarrage rapide
Guía de inicio rápido

CAN ICES-3 B/NMB-3 B

<QSG_DMHW2700NEXUC_A>

English

This guide is intended to guide you through the basic functions of this unit.
For details, please refer to the Operation manual stored on the website.

<https://www.pioneerelectronics.com/PUSA/>



<https://www.pioneerelectronics.ca/POCEN/>



Français

Ce guide est destiné à vous guider dans les fonctions de base de cet appareil.
Pour les détails, veuillez vous reporter au Mode d'emploi disponible sur le site Web.

<https://www.pioneerelectronics.com/PUSA/>



<https://www.pioneerelectronics.ca/POCEN/>



Español

Esta guía tiene como fin explicar las funciones básicas de esta unidad.
Para obtener más información, consulte el manual de operaciones que se encuentra en el sitio web.

<https://www.pioneerelectronics.com/PUSA/>



<https://www.pioneerelectronics.ca/POCEN/>



Precaution

Information to user

- This device contains licence-exempt transmitter(s)/receiver(s) that complies with Part 15 of FCC Rules and Innovation, Science, and Economic Development Canada licence-exempt RSS(s). Operation is subject to the following two conditions: (1) this device may not cause interference, and (2) this device must accept any interference, including interference that may cause undesired operation of this device.
- The Bluetooth antenna cannot be removed (or replaced) by user.
- This equipment complies with FCC/ISED radiation exposure limits set forth for an uncontrolled environment and meets the FCC radio frequency (RF) Exposure Guidelines and RSS-102 of the ISED radio frequency (RF) Exposure rules. This equipment should be installed and operated keeping the radiator at least 20 cm or more away from person's body.

- This transmitter must not be co-located or operated in conjunction with any other antenna or transmitter.
- Information to User - Alteration or modifications carried out without appropriate authorization may invalidate the user's right to operate the equipment.
- NOTE: This equipment has been tested and found to comply with the limits for a Class B digital device, pursuant to Part 15 of the FCC Rules. These limits are designed to provide reasonable protection against harmful interference in a residential installation. This equipment generates, uses and can radiate radio frequency energy and, if not installed and used in accordance with the instructions, may cause harmful interference to radio communications. However, there is no guarantee that interference will not occur in a particular installation. If this equipment does cause harmful interference to radio or television reception, which can be determined by turning the equipment off and on, the user is encouraged to try to correct the interference by one or more of the following measures:
 - Reorient or relocate the receiving antenna.
 - Increase the separation between the equipment and receiver.
 - Connect the equipment into an outlet on a circuit different from that to which the receiver is connected.
 - Consult the dealer or an experienced radio/TV technician for help.

FEDERAL COMMUNICATIONS COMMISSION SUPPLIER'S DECLARATION OF CONFORMITY

Product Name: RDS AV RECEIVER

Model Number: DMH-W2770NEX, DMH-W2700NEX

Responsible Party Name: PIONEER ELECTRONICS (USA) INC. SERVICE SUPPORT DIVISION

Address: 2050 W. 190TH STREET, SUITE 100, TORRANCE, CA 90504, U.S.A.

Phone: (800) 421-1404

URL: <http://www.pioneerelectronics.com>

 **WARNING**

- Slots and openings in the cabinet are provided for ventilation to ensure reliable operation of the product, and to protect it from overheating. To prevent fire hazard, the openings should never be blocked or covered with items (such as papers, floor mat, cloths).

- Do not ingest the battery, Chemical Burn Hazard.

The remote control supplied or sold separately with this product contains a coin/button cell battery. If the coin/button cell battery is swallowed or placed inside any part of the body, it can cause severe internal burns or other severe injuries in 2 hours or less and can lead to death.

Keep new and used batteries away from children.

If the battery compartment does not close securely, stop using the product and keep it away from children.

If you think batteries might have been swallowed or placed inside any part of the body, seek immediate medical attention.

The Safety of Your Ears is in Your Hands

Get the most out of your equipment by playing it at a safe level—a level that lets the sound come through clearly without annoying blaring or distortion and, most importantly, without affecting your sensitive hearing. Sound can be deceiving.

Over time, your hearing “comfort level” adapts to higher volumes of sound, so what sounds “normal” can actually be loud and harmful to your hearing. Guard against this by setting your equipment at a safe level BEFORE your hearing adapts.

► ESTABLISH A SAFE LEVEL:

- Set your volume control at a low setting.
- Slowly increase the sound until you can hear it comfortably and clearly, without distortion.
- Once you have established a comfortable sound level, set the dial and leave it there.

► BE SURE TO OBSERVE THE FOLLOWING GUIDELINES:

- Do not turn up the volume so high that you can't hear what's around you.
- Use caution or temporarily discontinue use in potentially hazardous situations.
- Do not use headphones while operating a motorized vehicle; the use of headphones may create a traffic hazard and is illegal in many areas.

English

Preparing the remote control (DMH-W2770NEX)

Remove the insulation sheet before use.

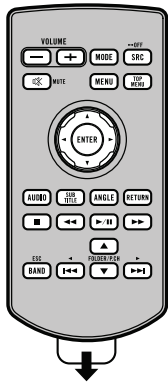

How to replace the battery

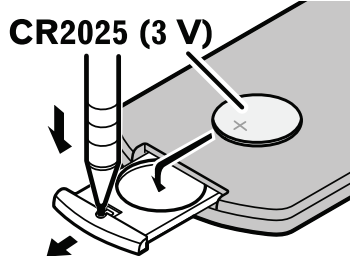

Insert the CR2025 (3 V) battery with the plus (+) and minus (-) poles orientated properly.

WARNING

Batteries (battery pack or batteries installed) must not be exposed to excessive heat such as sunshine, fire or the like.

CAUTION

- Remove the battery if the remote control is not used for a month or longer.
- There is a danger of explosion if the battery is incorrectly replaced. Replace only with the same or equivalent type.
- Do not expose a battery to high or low extreme temperatures during use, storage or transportation.
- Do not allow the battery to be exposed to fire or excessive heat or to become crushed or cut, or dispose of the battery in a fire or hot oven, which could result in an explosion.
- Do not handle the battery with metallic tools.
- Do not store the battery with metallic objects.
- If the battery leaks, wipe the remote control completely clean and install a new battery.
- When disposing of used batteries, please comply with governmental regulations or environmental public institution's rules that apply in your country/area.
- "Perchlorate Material – special handling may apply. See www.dtsc.ca.gov/hazardouswaste/perchlorate. (Applicable to California, U.S.A.)"

Using the remote control

Point the remote control in the direction of the front panel to operate.

NOTE

The remote control may not function properly in direct sunlight.

Important

- Do not store the remote control in high temperatures or direct sunlight.
- Do not let the remote control fall onto the floor, where it may become jammed under the brake or gas pedal.

Meanings of symbols used in this manual



Touch

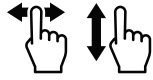

Touch and slide



Touch and hold

What's What

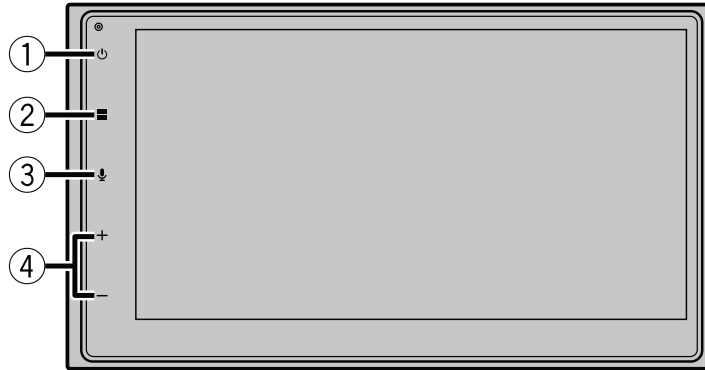

①		Display off Power off
②		Display the top menu screen Mute or unmute
③		Activate the voice recognition mode Display mobile device search screen
④	VOL (+/-)	Adjust the volume

Selecting the source



①









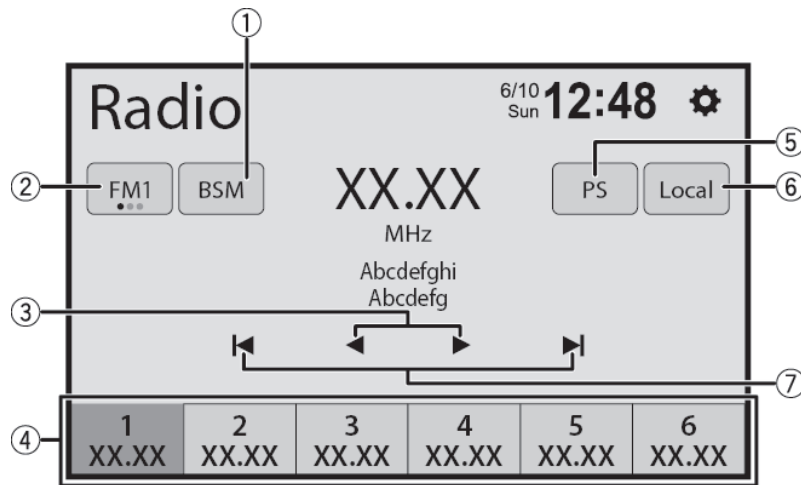

Select a source



Display hidden sources





Tuner operation

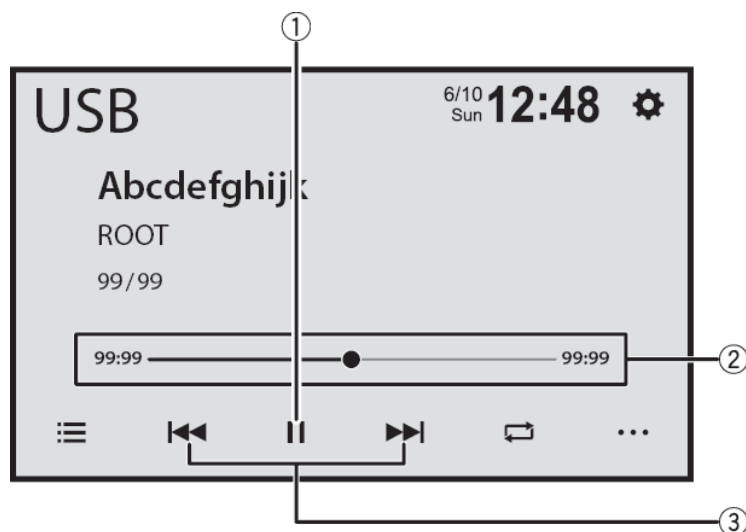

①	 Store the strongest broadcast frequencies
②	 Select a band
③	 Tune into the next station
④	 Recall the preset channel stored to a key from memory  Store the current broadcast frequency to a key
⑤	 Recall a preset channel in order and broadcast each channel for 10 seconds.
⑥	 Tune into only radio stations with sufficiently strong signals
⑦	 Start seek turning





Moving images operation

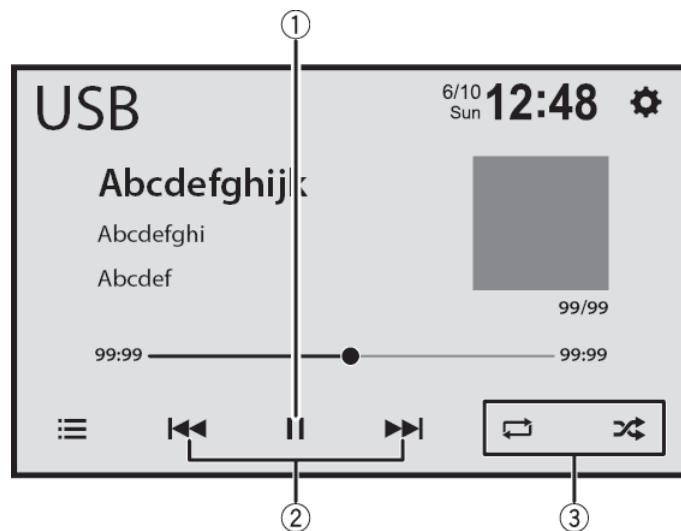

①	 Pause and start playback
②	 Change the playback point
③	 Selects the previous file or the next file.  Performs fast forward or fast reverse. Touch again to change the playback speed.





Audio operation



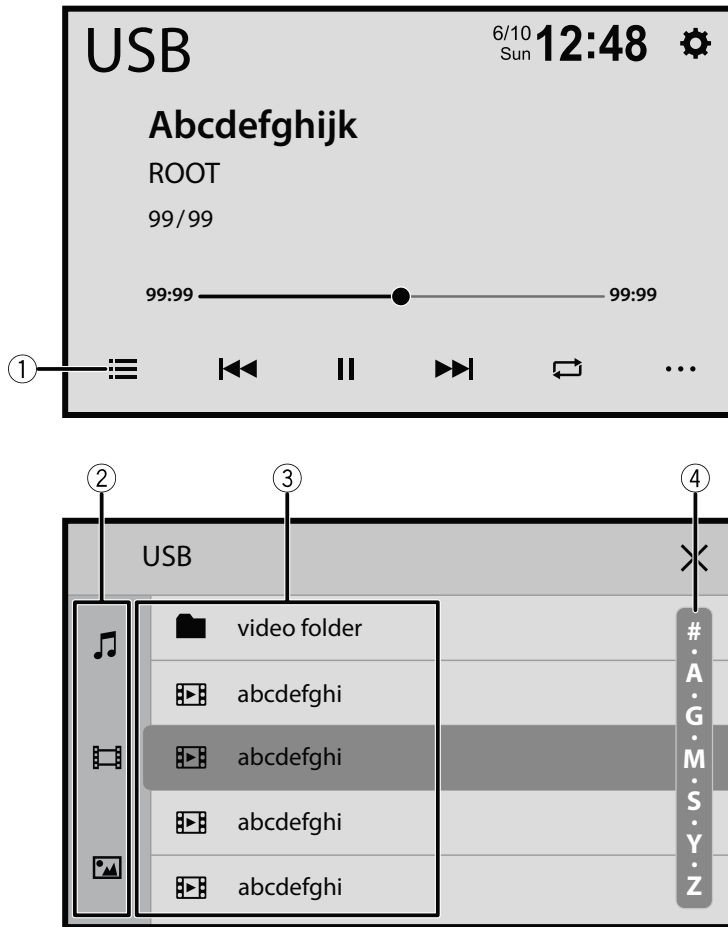





①	 Pause and start playback
②	 Selects the previous file or the next file.  Performs fast forward or fast reverse. Touch again to change the playback speed.
③	 Set the function for playing audio

List search operation



①	 Display the playlist screen
②	 Select the media file types
③	 Select a list title or folder that you want to play
④	 Scroll the list

Bluetooth® connection





- 1   →   →  [Yes] or .
- 2  the Bluetooth device name.

NOTE

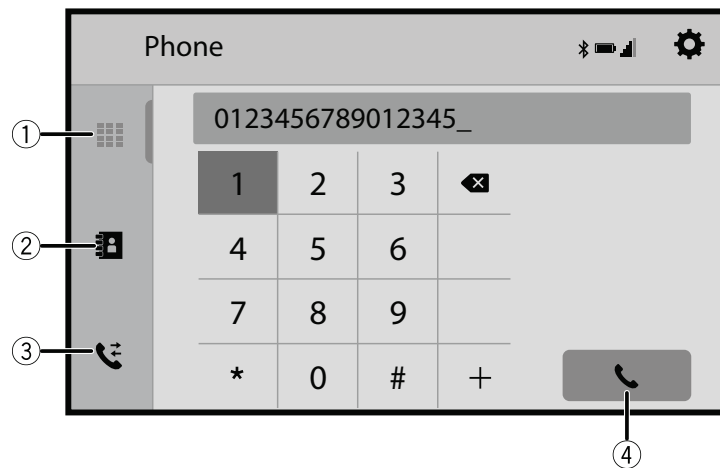
The *Bluetooth*® word mark and logos are registered trademarks owned by Bluetooth SIG, Inc. and any use of such marks by Pioneer Corporation is under license. Other trademarks and trade names are those of their respective owners.

Bluetooth telephone operation



①	 Enter the phone number directly
②	 Switch to the phone book mode
③	 Switch to the call history list
④	 Make an outgoing call



**PIONEER ELECTRONICS (USA) INC.
LIMITED WARRANTY**

WARRANTY VALID ONLY IN COUNTRY OF PRODUCT PURCHASE

WARRANTY

Pioneer Electronics (USA) Inc. (Pioneer) warrants that Pioneer® Car/Marine Electronics, Speaker, and Accessory Products distributed by Pioneer in the U.S.A. and Canada that fail to function properly under normal use due to a manufacturing defect when installed and operated according to the owner's manual enclosed with the unit will be repaired or replaced with a unit of comparable value, at Pioneer's option, without charge to you for parts or actual repair work. Replacement units and/or parts supplied under this warranty may be new or rebuilt at Pioneer's option.

This Limited Warranty applies to the original or any subsequent owner of this Pioneer product during the warranty period provided the product was purchased from an authorized Pioneer dealer in the U.S.A. or Canada. **You will be required to provide a sales receipt or other valid proof of purchase showing the date of original purchase. In the event service is required, the product must be delivered within the warranty period, transportation prepaid, only from within the country of purchase as explained in this document. You will be responsible for removal and installation of the product.** Pioneer will pay to return the repaired or replacement product to you within the country of purchase.

PRODUCT WARRANTY PERIOD (Runs from the date of first retail sale)	Parts	Labor
Car/Marine Electronics, Speakers, and Accessories (excluding Blind Spot Detection System).....	1 Year	1 Year
Blind Spot Detection System	3 Years	3 Years

WHAT IS NOT COVERED

This Limited Warranty applies to Pioneer products that are purchased from an authorized Pioneer dealer. **IF THIS PRODUCT WAS PURCHASED FROM ANY OTHER SOURCE, THERE ARE NO WARRANTIES, EXPRESS OR IMPLIED, INCLUDING THE IMPLIED WARRANTY OF MERCHANTABILITY AND THE IMPLIED WARRANTY OF FITNESS FOR A PARTICULAR PURPOSE AND THIS PRODUCT IS SOLD STRICTLY "AS IS" AND "WITH ALL FAULTS."** PIONEER SHALL NOT BE LIABLE FOR ANY CONSEQUENTIAL AND/OR INCIDENTAL DAMAGES. Some states and provinces do not allow the exclusion or limitation of incidental or consequential damages, so the above limitation or exclusion may not apply to you.

Pioneer does not warrant any product listed above when it is used in a trade or business or in any industrial or commercial application. This warranty does not apply if the product has been subjected to power in excess of its published power rating. This warranty does not cover cosmetic scratches or any other appearance item; damage or defects resulting from alterations or modifications not authorized in writing by Pioneer; accident, collisions, misuse or abuse; the use of unauthorized parts or labor; improper installation or maintenance; lightning or power surges; subsequent damage from leaking; damage from inoperative batteries; or the use of batteries not conforming to those specified in the owner's manual. This warranty does not cover the cost of parts or labor that would otherwise be provided without charge under this warranty obtained from any source other than Pioneer. Altered, defaced, or removed serial numbers void this warranty.

NO OTHER WARRANTIES

TO THE FULLEST EXTENT PERMITTED BYLAW, PIONEER MAKES NO REPRESENTATIONS OR WARRANTIES OR ACCEPTS ANY CONDITIONS WITH RESPECT TO THIS PRODUCT EXCEPT AS STATED IN THIS DOCUMENT. PIONEER LIMITS ITS OBLIGATIONS UNDER ANY IMPLIED WARRANTIES AND CONDITIONS INCLUDING, BUT NOT LIMITED TO, WARRANTIES AND CONDITIONS, WHETHER EXPRESS OR IMPLIED, OF MERCHANTABILITY AND FITNESS FOR A PARTICULAR PURPOSE, TO A PERIOD NOT TO EXCEED THE WARRANTY PERIOD. NO WARRANTIES OR CONDITIONS SHALL APPLY AFTER THE WARRANTY PERIOD. Some states and provinces do not allow limitations on how long an implied warranty lasts, so the above limitations or exclusions may not apply to you.

This warranty gives you specific legal rights, and you may also have other rights which vary from state to state or province to province. To the extent any provision of this limited warranty is deemed invalid or unenforceable under applicable law, such determination will have no effect on the remaining provisions, which will continue in full force and effect.

TO OBTAIN SERVICE

In the U.S.A. or Canada, to receive warranty service, you need to present your sales receipt showing place and date of original owner's transaction. **Please contact one of the following to obtain service:**

Your Authorized Pioneer Dealer - Your Pioneer Dealer may repair or replace your unit or refer you to an Authorized Pioneer Service Company. Your sales receipt should list the contact information (phone number, fax, email, etc.) for your Dealer.

Pioneer Customer Support - Can advise the optimal service option for your model and geographic location.

Please call us at **1-800-421-1404** or visit **www.pioneerelectronics.com** (for USA) or **http://www.pioneerelectronics.ca** (for Canada), click on "**Support**," then select "**Contact Us**."

Your Authorized Pioneer Service Company - Can perform repairs for most Car/Marine Electronics, Speaker and Accessory products and advise other options as applicable. Please visit Pioneer's website, click on "**Support**," and select "**Find a Service Center**."

Shipping Your Unit for Service – YOU MUST FIRST CONTACT PIONEER TO GET RETURN AUTHORIZATION. PLEASE DO NOT SEND IN YOUR PRODUCT WITHOUT CONTACTING CUSTOMER SUPPORT. If you have a return authorization number, please package the product carefully and send it transportation prepaid by a traceable, insured method to an Authorized Pioneer Service Company or Pioneer. Use adequate padding material to prevent damage in transit. Include your name, address and a telephone number where you can be reached during business hours.

For questions about your product, please contact Pioneer Customer Support as described above or write to us at:

**Customer Support, Pioneer Electronics (USA) Inc.
P.O. Box 1720
Long Beach, California 90801 U.S.A.**

DISPUTE RESOLUTION

Following our response to any initial request to Customer Support, should a dispute arise between you and Pioneer, Pioneer makes available its Complaint Resolution Program to resolve the dispute. The Complaint Resolution Program is available to you without charge. In the U.S.A., you are required to use the Complaint Resolution Program before you exercise any rights under, or seek any remedies, created by the Magnuson-Moss Warranty Act but may be entitled to file suit under state law without using the Complaint Resolution Program. To use the Complaint Resolution Program, call 1-800-421-1404 and explain to the customer service representative the problem you are experiencing, steps you have taken to have the product repaired during the warranty period, and the name of the authorized Pioneer Dealer from which the Pioneer product was purchased. After the complaint has been explained to the representative, a resolution number will be issued. Within forty (40) days of receiving your complaint, Pioneer will investigate the dispute and will either: (1) respond to your complaint in writing informing you what action Pioneer will take, and in what time period, to resolve the dispute; or (2) respond to your complaint in writing informing you why Pioneer will not take any action.

RECORD THE PLACE AND DATE OF PURCHASE. KEEP THIS INFORMATION AND YOUR SALES RECEIPT IN A SAFE PLACE

Model No. _____ Serial No. _____ Purchase Date _____

Purchased From _____



**PIONEER ELECTRONICS (USA) INC.
GARANTIE LIMITÉE**

GARANTIE VALIDE UNIQUEMENT DANS LE PAYS D'ACHAT DU PRODUIT

GARANTIE

Pioneer Electronics (USA) Inc. (ci-après « Pioneer ») garantit que les appareils électroniques, haut-parleurs et accessoires automobiles/marins Pioneer® distribués par Pioneer aux États-Unis et au Canada, s'ils sont installés et utilisés conformément au manuel de l'utilisateur qui accompagne l'appareil et ne fonctionnent pas correctement dans des conditions normales d'utilisation en raison d'un défaut de fabrication, seront réparés ou remplacés par un appareil de valeur comparable, à la discrétion de Pioneer, sans frais de pièces ou de réparation. Les appareils de remplacement et/ou pièces fournies en vertu de cette garantie peuvent être neufs ou remis à neuf, à la discrétion de Pioneer.

Cette garantie limitée s'applique au propriétaire initial ou à tout propriétaire ultérieur de ce produit Pioneer pendant la période de garantie, sous réserve que le produit ait été acheté d'un détaillant Pioneer autorisé aux États-Unis ou au Canada. **Vous devrez fournir un reçu de caisse ou autre preuve d'achat valide indiquant la date de l'achat initial. Si une réparation s'avère nécessaire, le produit doit être expédié dans la période de garantie, frais de port prépayés, uniquement depuis le pays de l'achat, et tel qu'expliqué dans le présent document. Vous serez responsable du retrait et de l'installation du produit.** Pioneer paiera les frais de retour du produit réparé ou de remplacement, à l'intérieur du pays d'achat.

PÉRIODE DE GARANTIE DU PRODUIT (La garantie prend effet à compter de la première vente au détail)

	Pièces	Main d'oeuvre
Appareils électroniques, haut-parleurs et accessoires automobiles/marins	1 an	1 an
Systèmes de détection d'angles morts	3 ans	3 ans

ÉLÉMENTS NON COUVERTS PAR LA GARANTIE

Cette garantie limitée s'applique aux produits Pioneer achetés d'un détaillant Pioneer autorisé. **SI CE PRODUIT A ÉTÉ ACHETÉ DE TOUTE AUTRE SOURCE, IL N'Y A PAS DE GARANTIES, EXPLICITES OU IMPLICITES, Y COMPRIS LES GARANTIES IMPLICITES DE QUALITÉ MARCHANDE ET GARANTIES IMPLICITES D'ADAPTATION À UN USAGE PARTICULIER, ET CE PRODUIT EST VENDU « TEL QUEL » ET « AVEC TOUS SES DÉFAUTS ».** PIONEER NE SERA RESPONSABLE D'AUCUN DOMMAGE CONSÉCUTIF ET/OU ACCESSOIRE. Certains États et certaines provinces n'autorisent pas l'exclusion ou la limitation des dommages consécutifs ou indirects, par conséquent, la limitation ou l'exclusion indiquée plus haut peut ne pas s'appliquer à vous.

Pioneer ne garantit aucun des produits énumérés ci-dessus s'ils sont utilisés à des fins commerciales ou professionnelles, ou dans toute application industrielle ou commerciale. Cette garantie ne s'applique pas si le produit a été soumis à une puissance nominale excédant celle indiquée dans les documents s'y appliquant. Cette garantie ne couvre pas les rayures ou tout autre élément esthétique ; les dommages ou défauts résultant de retouches ou modifications non autorisées par écrit par Pioneer ; les accidents, collisions, usages inappropriés ou abusifs ; l'utilisation non autorisée de pièces ou de main-d'œuvre ; l'installation ou la maintenance inadéquate ; les dommages causés par la foudre ou la surtension ; les dommages découlant de fuites ; les dommages découlant de piles défectueuses ; ou l'utilisation de piles non conformes à celles spécifiées dans le manuel de l'utilisateur. Cette garantie ne couvre pas le coût des pièces ou de la main-d'œuvre qui seraient autrement offertes sans frais en vertu de la présente garantie, si elles sont obtenues auprès d'une source autre que Pioneer. Les numéros de série modifiés, oblitérés ou enlevés annulent cette garantie.

INVALIDITÉ DE TOUTES AUTRES GARANTIES

DANS TOUTE LA MESURE AUTORISÉE PAR LA LOI, SAUF DISPOSITION CONTRAIRE DANS LE PRÉSENT DOCUMENT, PIONEER NE FAIT AUCUNE REPRÉSENTATION ET N'OFFRE AUCUNE GARANTIE, NI N'ACCEPTÉ AUCUNE CONDITION CONCERNANT CE PRODUIT. PIONEER LIMITE SES OBLIGATIONS EN VERTU DE TOUTES GARANTIES ET CONDITIONS IMPLICITES, Y COMPRIS, MAIS SANS S'Y LIMITER, LES GARANTIES ET CONDITIONS, EXPRESSES OU IMPLICITES, DE COMMERCIALITÉ ET D'ADAPTATION À UN USAGE PARTICULIER, À UNE PÉRIODE N'EXCÉDANT PAS LA PÉRIODE DE GARANTIE. AUCUNE GARANTIE OU CONDITION NE S'APPLIQUERA APRÈS LA PÉRIODE DE GARANTIE. Certains états et certaines provinces n'autorisent pas les limitations sur la durée d'une garantie implicite. Par conséquent, il se pourrait que certaines des limitations ou exclusions précitées ne s'appliquent pas à vous. Cette garantie vous confère des droits spécifiques légaux, mais vous pouvez bénéficier d'autres droits qui peuvent varier selon les États ou les provinces. Dans la mesure où toute disposition de cette garantie limitée est considérée comme invalide ou inexécutable en vertu du droit applicable, elle sera sans effet sur les autres dispositions, qui resteront pleinement en vigueur.

DEMANDE DE SERVICE

Aux États-Unis et au Canada, pour recevoir un service de garantie vous devez présenter votre reçu de caisse indiquant le lieu et la date de la transaction d'origine.

Pour toute demande de service, veuillez contacter :

Votre détaillant Pioneer autorisé - Votre détaillant Pioneer peut réparer ou remplacer votre appareil ou vous mettre en contact avec une entreprise de services Pioneer autorisée. Vous devriez trouver les coordonnées (numéro de téléphone, numéro de télécopieur, adresse de courriel, etc.) de votre détaillant sur votre reçu de caisse.

Support à la clientèle Pioneer - peut vous conseiller sur le choix de l'option de service optimal pour votre modèle et votre région géographique. Appelez-nous au **1-800-421-1404** ou visitez notre site Web à **www.pioneerelectronics.com** (pour les États-Unis) ou **http://www.pioneerelectronics.ca** (pour le Canada), cliquez sur « **Soutien** », puis sélectionnez « **Contactez-nous** ».

Votre entreprise de services Pioneer autorisée - peut effectuer des réparations pour la plupart des produits électroniques automobiles/marins, des haut-parleurs et des accessoires et peut vous conseiller sur le choix d'autres options, selon le cas. Visitez le site Web de Pioneer, cliquez sur « **Soutien** », puis sélectionnez « **Trouver un Centre de service** ».

Expédition de votre appareil aux fins de service — VOUS DEVEZ D'ABORD CONTACTER PIONEER POUR OBTENIR UNE AUTORISATION DE RETOUR. VEUILLEZ NE PAS ENVOYER VOTRE PRODUIT SANS AVOIR D'ABORD CONTACTÉ LE SERVICE À LA CLIENTÈLE. Si vous avez un numéro d'autorisation de retour, veuillez emballer le produit soigneusement et l'envoyer, frais de port prépayés avec un service d'expédition traçable et assurable, à une société de services Pioneer autorisée ou à Pioneer. Utilisez des matériaux d'emballage coussinés adéquats pour éviter les dommages pendant le transport. Incluez votre nom, votre adresse et un numéro de téléphone où nous pouvons vous joindre pendant les heures de bureau.

Pour toute question concernant votre produit, veuillez contacter le soutien à la clientèle Pioneer comme décrit ci-dessus ou écrivez-nous à :

Customer Support, Pioneer Electronics (USA) Inc., P.O. Box 1720, Long Beach, California 90801 U.S.A.

RÈGLEMENT DES CONFLITS

Dans le cas d'un conflit entre vous et Pioneer après notre réponse à votre demande initiale adressée service à la clientèle (Customer Support), Pioneer met à votre disposition son Programme de résolution des plaintes pour résoudre le conflit. Le Programme de résolution des plaintes est disponible sans frais. Aux États-Unis, vous êtes tenu de recourir au Programme de règlement des plaintes avant d'exercer vos droits ou d'exiger réparation en vertu de la loi sur la garantie « Magnuson-Moss Warranty Act », mais vous êtes en droit d'engager une action en justice en vertu des lois de l'État sans passer par le Programme de résolution des plaintes. Pour avoir recours au Programme de résolution des plaintes, composez le 1-800-421-1404 et décrivez au représentant du service à la clientèle le problème que vous rencontrez et les démarches que vous avez entreprises pour faire réparer le produit pendant la période de garantie, et donnez-lui le nom du détaillant Pioneer autorisé auprès duquel vous vous êtes procuré le produit Pioneer. Une fois que votre plainte a été expliquée au représentant, un numéro de résolution vous sera communiqué. Pioneer étudiera le conflit et, dans un délai de quarante (40) jours après la réception de votre plainte, (1) répondra à votre plainte par écrit pour vous aviser des démarches qu'elle entreprendra pour résoudre le conflit, et indiquera combien de temps ces démarches prendront ; ou (2) répondra à votre plainte par écrit pour vous indiquer les raisons pour lesquelles Pioneer n'entreprendra aucune démarche.

ENREGISTREZ LE LIEU ET LA DATE D'ACHAT. CONSERVEZ CES INFORMATIONS ET VOTRE REÇU DE CAISSE DANS UN ENDROIT SÛR

No. de Modèle. _____ No. de série _____ Date d'achat _____

Acheté de _____