

CAUTION/PRÉCAUTION/ATTENZIONE/PRECAUCIÓN/VORSICHT/LET OP/ CUIDADO

English

Do not forcibly insert this unit into the dashboard/console when installing. Applying excessive force to the connectors (HDMI and USB Type-C®) may cause a malfunction.

Français

Ne pas forcer l'insertion de cette unité dans le tableau de bord/la console lors de l'installation. Appliquer une force excessive au niveau des connecteurs (HDMI et USB Type-C®) peut causer des problèmes de fonctionnement.

Italiano

Durante l'installazione, non inserire forzatamente l'unità nel cruscotto/console. L'applicazione di forza eccessiva ai connettori (HDMI e USB Type-C®) può causare malfunzionamenti.

Español

No utilice la fuerza al introducir esta unidad en el salpicadero/console durante la instalación. La aplicación de una fuerza excesiva a los conectores (HDMI y USB Type-C®) puede provocar un funcionamiento incorrecto.

Deutsch

Führen Sie dieses Gerät bei der Installation nicht mit Gewalt in das Armaturenbrett/die Konsole ein. Wenn übermäßige Kraft auf die Anschlüsse (HDMI und USB Type-C®) ausgeübt wird, kann dies zu einer Fehlfunktion führen.

Nederlands

Gebruik geen overdreven kracht bij het installeren van dit toestel in het dashboard/console. Onnodig veel druk uitoefenen op de aansluitingen (HDMI en USB Type-C®) kan een storing veroorzaken.

Português (B)

Ao instalar, não insira essa unidade à força no painel de instrumentos/console. Aplicar força excessiva nos conectores (HDMI e USB Type-C®) pode causar mau funcionamento.

Pioneer

DMH-WT8600NEX

DMH-WT7600NEX

DMH-WC6600NEX

DMH-W4660NEX

DMH-W4600NEX

RDS AV RECEIVER

HD Radio®

This HD Radio receiver enables:

PSD

HD2/HD3

Digital Sound

Artist Experience

Metra
THE INSTALLER'S CHOICE

SiriusXM
READY

 **gracenote.**
A NIELSEN COMPANY

Operation Manual

Important (Serial number)

The serial number is located on the bottom of this unit. For your own security and convenience, be sure to record this number on the enclosed warranty card.

Contents

Thank you for buying this Pioneer product.
Please read through these instructions so you will know how to operate your model properly. After you have finished reading the instructions, keep this document in a safe place for future reference.

Important

The screen shown in the examples may differ from actual screens, which may be changed without notice for performance and function improvements.

■ Precaution	4
■ Parts and controls	11
■ Basic operation	13
■ Bluetooth®	24
■ Wi-Fi®	33
■ Browser	38
■ CarAVAssist	41
■ Source/application	44
■ HD Radio™ Technology/Radio	47
■ USB	53
■ iPhone®	60
■ Apple CarPlay™	64
■ Android Auto™	67
■ Sports	71
■ Weather	72
■ Amazon Alexa	74
■ SiriusXM® Satellite Radio	81
■ HDMI	89
■ AUX	90

■ External component	92
■ iDatalink	93
■ Metra Axxess	98
■ Settings.....	101
Displaying the setting screen	101
System settings	101
Theme settings.....	110
Audio settings	112
Video settings	116
Communication settings.....	117
■ Favorite menu	119
■ Other functions	120
■ Appendix	122

Precaution

Information to user

- This device contains licence-exempt transmitter(s)/receiver(s) that complies with Part 15 of FCC Rules and Innovation, Science, and Economic Development Canada licence-exempt RSS(s). Operation is subject to the following two conditions: (1) this device may not cause interference, and (2) this device must accept any interference, including interference that may cause undesired operation of this device.
- The Bluetooth antenna cannot be removed (or replaced) by user.
- This equipment complies with FCC/ISED radiation exposure limits set forth for an uncontrolled environment and meets the FCC radio frequency (RF) Exposure Guidelines and RSS-102 of the ISED radio frequency (RF) Exposure rules. This equipment should be installed and operated keeping the radiator at least 20 cm or more away from person's body.

- This transmitter must not be co-located or operated in conjunction with any other antenna or transmitter.
- Alteration or modifications carried out without appropriate authorization may invalidate the user's right to operate the equipment.
- NOTE: This equipment has been tested and found to comply with the limits for a Class B digital device, pursuant to Part 15 of the FCC Rules. These limits are designed to provide reasonable protection against harmful interference in a residential installation. This equipment generates, uses and can radiate radio frequency energy and, if not installed and used in accordance with the instructions, may cause harmful interference to radio communications. However, there is no guarantee that interference will not occur in a particular installation. If this equipment does cause harmful interference to radio or television reception, which can be determined by turning the equipment off and on, the user is encouraged to try to correct the interference by one or more of the following measures:
 - Reorient or relocate the receiving antenna.
 - Increase the separation between the equipment and receiver.
 - Connect the equipment into an outlet on a circuit different from that to which the receiver is connected.
 - Consult the dealer or an experienced radio/TV technician for help.

FEDERAL COMMUNICATIONS COMMISSION SUPPLIER'S DECLARATION OF CONFORMITY

Product Name: RDS AV RECEIVER

Model Number: DMH-WT8600NEX, DMH-WT7600NEX, DMH-WC6600NEX, DMH-W4660NEX, DMH-W4600NEX

Responsible Party Name: PIONEER ELECTRONICS (USA), INC. SERVICE SUPPORT DIVISION

Address: 2050 W. 190TH STREET, SUITE 100, TORRANCE, CA 90504, U.S.A.

Phone: 1-800-421-1404

URL: <https://www.pioneerelectronics.com/PUSA/>

CAN ICES-3 B/NMB-3 B

⚠ WARNING

Slots and openings in the cabinet are provided for ventilation to ensure reliable operation of the product, and to protect it from overheating. To prevent fire hazard, the openings should never be blocked or covered with items (such as papers, floor mat, cloths).

⚠ CAUTION

This product is evaluated in moderate and tropical climate condition under the Audio, video and similar electronic apparatus - Safety requirements, IEC 60065.

The Safety of Your Ears is in Your Hands

Get the most out of your equipment by playing it at a safe level—a level that lets the sound come through clearly without annoying blaring or distortion and, most importantly, without affecting your sensitive hearing. Sound can be deceiving.

Over time, your hearing “comfort level” adapts to higher volumes of sound, so what sounds “normal” can actually be loud and harmful to your hearing. Guard against this by setting your equipment at a safe level BEFORE your hearing adapts.

▶ ESTABLISH A SAFE LEVEL:

- Set your volume control at a low setting.
- Slowly increase the sound until you can hear it comfortably and clearly, without distortion.
- Once you have established a comfortable sound level, set the dial and leave it there.

▶ BE SURE TO OBSERVE THE FOLLOWING GUIDELINES:

- Do not turn up the volume so high that you can't hear what's around you.
- Use caution or temporarily discontinue use in potentially hazardous situations.
- Do not use headphones while operating a motorized vehicle; the use of headphones may create a traffic hazard and is illegal in many areas.

Important safety information**⚠ WARNING**

- Do not attempt to install or service this product by yourself. Installation or servicing of this product by persons without training and experience in electronic equipment and automotive accessories may be dangerous and could expose you to the risk of electric shock, injury or other hazards.
- Do not allow this product to come into contact with liquids. Electrical shock could result. Also, damage to the product, smoke, and overheating could result from contact with liquids.
- If liquid or foreign matter should get inside this product, park your vehicle in a safe place, turn the ignition switch off (ACC OFF) immediately and consult your dealer or the nearest authorized Pioneer Service Station. Do not use this product in this condition because doing so may result in a fire, electric shock, or other failure.
- If you notice smoke, a strange noise or odor from this product, or any other abnormal signs on the LCD screen, turn off the power immediately and consult your dealer or the nearest authorized

Pioneer Service Station. Using this product in this condition may result in permanent damage to the system.

- Do not disassemble or modify this product, as there are high-voltage components inside which may cause an electric shock. Be sure to consult your dealer or the nearest authorized Pioneer Service Station for internal inspection, adjustments or repairs.
- Do not ingest the battery, Chemical Burn Hazard.

(The remote control supplied or sold separately with) This product contains a coin/button cell battery. If the coin/button cell battery is swallowed, it can cause severe internal burns in just 2 hours and can lead to death.

Keep new and used batteries away from children.

If the battery compartment does not close securely, stop using the product and keep it away from children.

If you think batteries might have been swallowed or placed inside any part of the body, seek immediate medical attention.

Before using this product, be sure to read and fully understand the following safety information:

- Do not operate this product, any applications, or the rear view camera option (if purchased) if doing so will divert your attention in any way from the safe operation of your vehicle. Always observe safe driving rules and follow all existing traffic regulations. If you experience difficulty in operating this product, pull over, park your vehicle in a safe location and apply the parking brake before making the necessary adjustments.
- Never set the volume of this product so high that you cannot hear outside traffic and emergency vehicles.
- To promote safety, certain functions are disabled unless the vehicle is stopped and the parking brake is applied.
- Keep this manual handy as a reference for operating procedures and safety information.
- Do not install this product where it may (i) obstruct the driver's vision, (ii) impair the performance of any of the vehicle's operating systems or safety features, including air bags or hazard lamp buttons or (iii) impair the driver's ability to safely operate the vehicle.
- Please remember to fasten your seat belt at all times while operating your vehicle. If you are ever in an accident, your injuries can be considerably more severe if your seat belt is not properly buckled.
- Never use headphones while driving.
- Rear visibility systems (backup cameras) are required in certain new vehicles sold in the U.S. and Canada. U.S. regulations began according to a two year phase-in on May 1, 2016, and both the U.S. and Canada require that all such vehicles manufactured on or after May 1, 2018 have rear visibility systems. **Owners of vehicles equipped with compliant rear visibility systems should not install or use this product in a way that alters or disables that system's compliance with applicable regulations.** If you are unsure whether your vehicle has a rear visibility system subject to the U.S. or Canadian regulations, please contact the vehicle manufacturer or dealer.

If your vehicle has a compliant backup camera that displays the backup view through

the factory receiver, do not use the Pioneer receiver unless it is connected to and displays the same view as the factory backup camera. Connection to the factory backup camera will require an adaptor, sold separately. Not all vehicles may be able to connect. Please check with a qualified professional installer for installation options specific to your vehicle.

To ensure safe driving

WARNING

- **LIGHT GREEN LEAD AT POWER CONNECTOR IS DESIGNED TO DETECT PARKED STATUS AND MUST BE CONNECTED TO THE POWER SUPPLY SIDE OF THE PARKING BRAKE SWITCH. IMPROPER CONNECTION OR USE OF THIS LEAD MAY VIOLATE APPLICABLE LAW AND MAY RESULT IN SERIOUS INJURY OR DAMAGE.**
- **To avoid the risk of damage and injury and the potential violation of applicable laws, this product is not for use with a video image that is visible to the driver.**

In some countries the viewing of video image on a display inside a vehicle even by persons other than the driver may be illegal. Where such regulations apply, they must be obeyed.

If you attempt to watch video image while driving, the warning **“Viewing of front seat video source while driving is strictly prohibited.”** will appear on the screen. To watch video image on this display, stop the vehicle in a safe place and apply the parking brake. Please keep the brake pedal pushed down before releasing the parking brake.

When using a display connected to V OUT

The video output terminal (**V OUT**) is for connection of a display to enable passengers in the rear seats to watch video images.

WARNING

NEVER install the rear display in a location that enables the driver to watch video images while driving.

To avoid battery exhaustion

Be sure to run the vehicle engine while using this product. Using this product without running the engine can drain the battery.

WARNING

Do not install this product in a vehicle that does not have an ACC wire or circuitry available.

Camera function

With an optional rear view camera, you are able to use this product as an aid to keep an eye on trailers, or backing into a tight parking spot.

⚠ WARNING

- SCREEN IMAGE MAY APPEAR REVERSED.
- USE INPUT ONLY FOR REVERSE OR MIRROR IMAGE REAR VIEW CAMERA. OTHER USE MAY RESULT IN INJURY OR DAMAGE.

⚠ CAUTION

The rear view mode is to use this product as an aid to keep an eye on the trailers, or while backing up. Do not use this function for entertainment purposes.

Handling the USB connector

⚠ CAUTION

- To prevent data loss and damage to the storage device, never remove it from this product while data is being transferred.
- Pioneer cannot guarantee compatibility with all USB mass storage devices and assumes no responsibility for any loss of data on media players, iPhone, smartphone, or other devices while using this product.
- It may not be recognized properly by this product if a USB device that had been incorrectly disconnected from the computer is connected.

Failure to operate

After-sales service for Pioneer products

Please contact the dealer or distributor from which you purchased the product for after-sales service (including warranty conditions) or any other information. In case the necessary information is not available, please contact the companies listed below.

Please do not ship your product to the companies at the addresses listed below for repair without making advance contact.

-USA&CANADA

Pioneer Electronics (USA) Inc.

CUSTOMER SUPPORT DIVISION

P.O. Box 1760 Long Beach, CA 90801-1760

800-421-1404

For warranty information, please see the Limited Warranty sheet included with your product.

- When taking this product to the dealer or authorized Pioneer Service Station, make sure to bring both the unit and LCD display.*
- * DMH-WT8600NEX, DMH-WT7600NEX, DMH-WC6600NEX

Visit our website

Visit us at the following site:

<https://www.pioneerelectronics.com/PUSA/>

<https://www.pioneerelectronics.ca/POCEN/>

- 1 Register your product.
- 2 Receive updates on the latest products and technologies.
- 3 Download owner's manuals, order product catalogs, research new products, and much more.
- 4 Receive notices of software upgrades and software updates.

Protecting the LCD panel and screen

- Do not expose the LCD screen to direct sunlight when this product is not used. This may result in LCD screen malfunction due to the resulting high temperatures.
- When using a cellular phone, keep the antenna of the cellular phone away from the LCD screen to prevent disruption of the video in the form of spots, colored stripes, etc.
- To protect the LCD screen from damage, be sure to touch the touch panel keys only with your finger and do so gently.
- A shatterproof film is attached to the unit's display. This film cannot be taken off or replaced with an alternative film. There may be glue on the edge of the film. However, this does not affect the usability of this unit.*

* DMH-WT8600NEX, DMH-WT7600NEX, DMH-WC6600NEX



Notes on internal memory



- The information will be erased by disconnecting the yellow lead from the battery (or removing the battery itself).
- Some of the settings and recorded contents will not be reset.

About this manual

- This manual uses diagrams of actual screens to describe operations. However, the screens on some units may not match those shown in this manual depending on the model used.
- When an iPhone is connected to the unit, the source name on the unit appears as [iPod]. Please note that this unit only supports iPhone regardless of the source name. For details of iPhone compatibility, refer to Compatible iPhone models (page 134).

Meanings of symbols used in this manual

	This indicates model names that are supported by the described operations.
	This indicates to touch the appropriate soft key on the touch screen.

	This indicates to touch and hold the appropriate soft key on the touch screen.
	This indicates to swipe in the direction of the arrow on the touch screen.
	This indicates to drag in the direction of the arrow on the touch screen.

Parts and controls

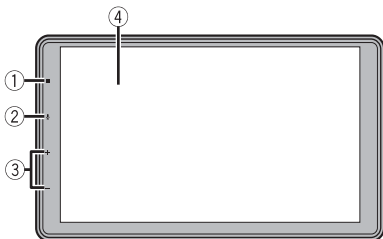

Main unit

8600NEX 7600NEX 6600NEX

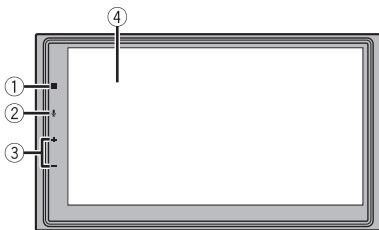

4660NEX 4600NEX



①		Touch to display the home menu screen. Touch and hold to power off. To power back on, touch any button.
②		Touch to activate the voice recognition mode such as Siri® when the iPhone is connected to the unit via Bluetooth or USB. Touch and hold to display mobile device search or select screen.
③		Volume
④	LCD screen	

Remote control

8600NEX 7600NEX 6600NEX 4660NEX

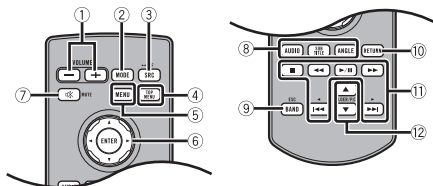

①	+/- VOLUME	Volume
②	MODE	Press to switch between the Application screen and the AV operation screen. Press and hold to turn off the display.
③	SRC/OFF	Press to cycle through all the available sources. Press and hold to turn the source off.
④	TOP MENU	Not used.
⑤	MENU	Not used.
⑥	ENTER	Not used.
⑦	MUTE	
⑧	AUDIO SUBTITLE ANGLE	Not used.
⑨	BAND/ESC	Press to select the tuner band when tuner is selected as a source. Press to cancel the control mode of functions.
⑩	RETURN	Not used.
⑪	▶/ 	Press to pause or resume playback or play from the beginning when resume is off.
	◀◀ or ▶▶	For audio: Press and hold to perform fast reverse or fast forward. For video: Press to perform fast reverse or fast forward.
	 ◀◀ or ▶▶ ▲ or ▼	Press to return to the previous track (file) or go to the next track (file). Press to answer or end a call.
	■	Press to stop playback. If you resume playback, playback will start from the point where you stopped. Press the button again to stop playback completely.
⑫	FOLDER/P.CH ◀ or ▶	Press to select the next or previous folder. Press to recall radio station frequencies assigned to preset channel keys. Press to answer or end a call.

4600NEX

The remote control is sold separately.

Basic operation

Preparing the remote control

8600NEX 7600NEX 6600NEX 4660NEX

Remove the insulation sheet before use.



How to replace the battery

CR2025 (3 V)

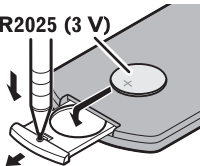

Insert the CR2025 (3 V) battery with the plus (+) and minus (-) poles orientated properly.

⚠ WARNING

Batteries (battery pack or batteries installed) must not be exposed to excessive heat such as sunshine, fire or the like.

⚠ CAUTION

- Remove the battery if the remote control is not used for a month or longer.
- There is a danger of explosion if the battery is incorrectly replaced. Replace only with the same or equivalent type.
- Do not handle the battery with metallic tools.
- Do not store the battery with metallic objects.
- If the battery leaks, wipe the remote control completely clean and install a new battery.
- When disposing of used batteries, please comply with governmental regulations or environmental public institution's rules that apply in your country/area.
- "Perchlorate Material – special handling may apply. See www.dtscc.ca.gov/hazardouswaste/perchlorate. (Applicable to California, U.S.A.)"

Using the remote control

Point the remote control in the direction of the front panel to operate.

NOTE

The remote control may not function properly in direct sunlight.

Important

- Do not store the remote control in high temperatures or direct sunlight.
- Do not let the remote control fall onto the floor, where it may become jammed under the brake or gas pedal.

Starting up the unit

1 Start the engine to boot up the system.

The [Select Program Language] screen appears.

NOTE

From the second time on, the screen shown will differ depending on the previous conditions.

2 Select the language.

3 Touch .

The [Speaker Mode Settings] screen appears.

4 Select the speaker mode.

[Standard Mode]

4-speaker system with front and rear speakers, or a 6-speaker system with front and rear speakers and subwoofers.

[Network Mode]

3-way system with a high range speaker, middle range speaker and subwoofer (low range speaker) for reproduction of high, middle and low frequencies (bands).

WARNING

Do not use the unit in Standard Mode when a speaker system for 3-way Network Mode is connected to the unit. This may cause damage to the speakers.

5 Touch [OK].

Initial Legal Disclaimer screen appears.

6 Touch [OK].

The home menu screen appears.

NOTE

Once the speaker mode is set, the setting cannot be changed unless this product is restored to the default settings. Restore the default settings to change the speaker mode setting (page 121).

Switching the speaker mode

To change the speaker mode, you need to restore this product to the default settings.

1 Restore the default setting (page 121).



Using the touch panel

You can operate this product by touching the keys on the screen directly with your fingers.

NOTE

To protect the LCD screen from damage, be sure to touch the screen only with your finger gently.

Common touch panel keys

- : Returns to the previous screen.
- : Close the screen.

Operating list screens

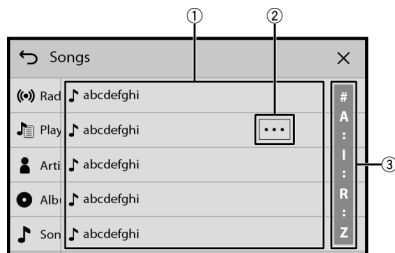

①	Touching an item on the list allows you to narrow down the options and proceed to the next operation.
②	Appears when all characters are not displayed on the display area. If you touch the key, the rests are scrolled for display. NOTE This function is available only when you stop your vehicle in a safe place and apply the parking brake.
③	Appears when items cannot be displayed on a single page. Drag the side bar, the initial search bar or the list to view any hidden items.

Operating the time bar

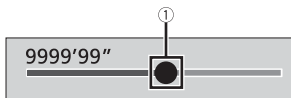

①

You can change the playback point by dragging the key.

The playback time corresponding to the position of the key is displayed while dragging the key.

Operating the on-screen keyboard

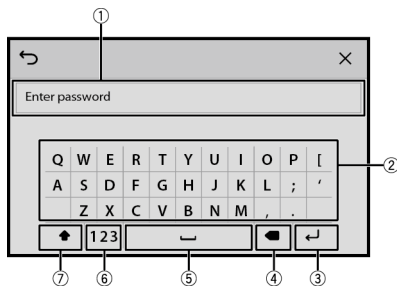

①

Displays the characters that are entered.

②

Enters the characters in the text box.

③

Confirms the entry and proceeds to the next step.

④

Deletes the input text to the left of the cursor one letter at a time.

⑤

Enters a space.

⑥









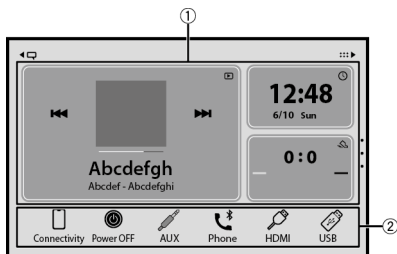

Switches between alphabet and numbers/symbols.

⑦

Switches between capital and lower case letters.

Home menu screen



①	 <p>Widget (page 22) Touch to see the selected source/application.</p>
	 <p>Customizing the widget (page 22) When you finish customizing, touch .</p>
②	 <p>Favorite source/application area Touch to see the selected source/application.</p>  <p>Customizing the home menu screen (page 18) The following items can be customized.</p> <ul style="list-style-type: none"> • Changing the home menu screen layout (page 18) • Rearranging the icons in the favorite source/application area (page 18) • Rearranging the displayed icons in the favorite source/application area (page 18) <p>When you finish customizing, touch .</p>
	Notification (page 21)
	Source/application (page 44)
	Favorite radio stations (page 18)
	Suggested radio stations (page 20)

Customizing the home menu screen

NOTES

- The layout of the widgets and favorite icons on the home menu screen is saved for each mobile device connected via Bluetooth. The layout changes depending on the mobile device that is connected to this unit.
- This function is available only when you stop your vehicle in a safe place and apply the parking brake.
- The [Connectivity] icon cannot be removed from the favorite source/application area.
- The [Connectivity] icon changes to the Apple CarPlay icon or Android Auto icon depending on your mobile device.

► Changing the home menu screen layout

- 1 Touch and hold the favorite source/application area.
- 2 Touch .
- 3 Select [Lower Dock Area] or [Upper Dock Area].

► Rearranging the icons in the favorite source/application area

- 1 Touch and hold the favorite source/application area.
- 2 Drag the icon to the desired position.
When you finish rearranging, touch .

► Rearranging the displayed icons in the favorite source/application area

- 1 Touch and hold the favorite source/application area.
The source/application list area appears on the screen.
- 2 Drag unneeded icon in the favorite source/application area to the source/application list area if the favorite source/application area is full.
- 3 Drag the icon to the desired location in the favorite source/application area.
When you finish rearranging, touch .

Favorite radio stations

Registering your favorite radio stations allows you to quickly jump to the registered radio stations.

Displaying the favorite radio stations screen

- 1 Touch  then swipe up on the screen.
Swipe down on the screen when you finish.

Favorite radio stations screen

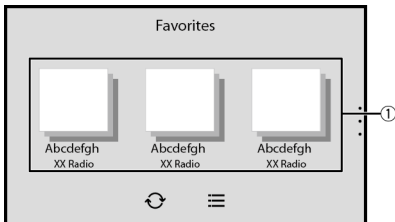

①	<p>Favorite radio stations Touch to make changes to the selected radio station.</p>
☰	<p>List of favorite radio stations Touch to select the favorite radio station from the list screen (page 19).</p>
↻	<p>Updates the favorite radio stations. The next 3 stations on the favorites list are displayed.</p> <p>NOTE This function is only available when there are more than 4 favorite radio stations on the list.</p>

List screen

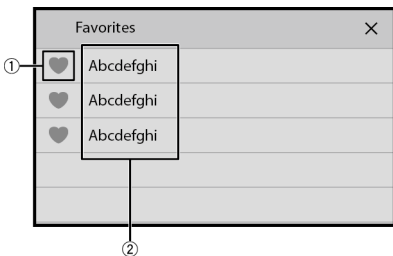

①	<p>Adds/removes a favorite.</p>
②	<p>Available radio stations Touch to tune in to the selected radio station.</p>

Suggested radio stations

This unit suggests radio stations to you according to your frequently listened music and radio stations.

Important



To use the suggested radio stations function, you may need to connect this unit to the Internet via a Wi-Fi network and set [Suggestions] (page 101) to [On].

Displaying the suggested radio stations screen

- 1 Touch  then swipe down on the screen.
Swipe up on the screen when you finish.

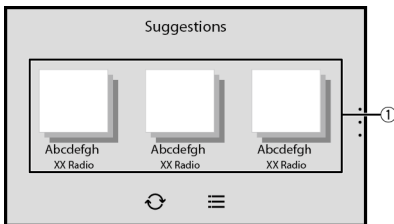
Suggested radio stations screen



①	<p>Suggested radio stations Touch to tune in to the selected radio station.</p>
	<p>List of suggested radio stations Touch to select the suggested radio station from the list screen (page 21).</p>
	<p>Updates the suggested radio stations. The next 3 stations on the suggested list are displayed.</p>
<p>NOTE This function is only available when there are more than 4 suggested radio stations on the list.</p>	

TIP

To reset the displayed suggested radio stations, it is necessary to restore all settings to the default settings in [Restore Settings] in  (page 105).

List screen



①

Available radio stations

Touch to tune in to the selected radio station.

Notification

Notification displays the notifications from the connected iPhone or smartphone (Android™) and sports information registered on CarAVAssist.

NOTES

- This function needs to be connected via Bluetooth to an iPhone or a smartphone with CarAVAssist installed (page 41). For details on Bluetooth connection, refer to Bluetooth connection (page 24).
- To use the sports notification function, you need to register a team in CarAVAssist and import it to this unit (page 42) in advance.
- To use the sports notification function, make sure that the GPS antenna is installed properly and this unit is connected to the Internet via a Wi-Fi network (page 33). For details on GPS antenna installation, refer to the Installation Manual.

Displaying the notification screen

- 1 Touch  then swipe right on the screen.
When you finish, swipe left on the screen.

Notification screen



①

Received notifications

Touch to display the details of the notification.



Widget

Widgets enable you to see your favorite sources and application information on the home menu screen and access shortcuts to them.

Customizing the widget

NOTE

This function is available only when you stop your vehicle in a safe place and apply the parking brake.



- 1 Touch .
- 2 Touch and hold the widgets area.
- 3 Touch the widget that you want to customize.
When you finish customizing, touch .

Widget customizing screen



①	<p>Widget area To rearrange the widgets, drag them to the desired locations. To remove a widget, drag the widget to ②.</p>
②	<p>Available source/application lists for the widgets Flick left/right to switch between widget lists.</p>
	<p>Adjusts the size of the widgets Touch a corner of the selected widget and drag it to adjust the size.</p> <p>TIP You can fit up to four widgets in the widgets area by adjusting their size.</p> <p>NOTE The size can only be adjusted for widgets that display an adjustment key.</p>

► Switching the widgets





- 1 Touch .
- 2 Touch and hold the widgets area.
- 3 Drag unwanted source/application widgets to the source/application list area.
A maximum of four widgets can fit in the widgets area.
- 4 Drag the desired source/application to the widgets area.
When you finish switching, touch .

NOTE

Some widgets cannot be placed together in the widgets area. Also, some widget functions may be limited due to the combination of widgets.

Bluetooth®

Bluetooth connection

- 1 Turn on the Bluetooth function on the device.
- 2 Touch  then swipe left on the screen.
- 3 Touch  then .
- 4 Touch [Connection].
- 5 Touch .
The unit starts to search for available devices, then displays them in the device list.
- 6 Touch  in the list.

TIP

If you touch the device name, the Wi-Fi connection for Apple CarPlay or Android Auto is established.



NOTES

- If five devices are already paired, a message prompting you to delete a paired device is displayed. Delete a paired device first (page 25).
- If your device supports SSP (Secure Simple Pairing), a six-digit number appears on the display of this product. Make sure that the six-digit number matches the one that is displayed on the mobile device before touching [Yes] to pair the device.
- If you try to connect an unconnected cellular phone while two cellular phones are already connected, the first one of the two connected cellular phones will be disconnected and the unconnected cellular phone will be connected instead.

TIPS

- The Bluetooth connection can also be made by detecting this product from the Bluetooth device. Before registration, make sure that [Visibility] in the [Bluetooth] menu is set to [On] (page 25). For details on Bluetooth device operations, refer to the operating instructions supplied with the Bluetooth device.
- Two cellular phones can be connected to this product at the same time (page 25).

Bluetooth settings

- 1 Touch  then swipe left on the screen.
- 2 Touch  then .
- 3 Touch [Bluetooth Settings].

CAUTION

Never turn this product off and disconnect the device while the Bluetooth setting operation is being processed.

Menu Item	Description
[Auto Connect] [On] [Off]	Select [On] to connect the last connected Bluetooth device automatically when using the hands-free phone function. NOTE If two Bluetooth devices were connected the last time, the two devices are connected to this product automatically in the order that they are registered in the device list.
[Visibility] [On] [Off]	Select [On] to make this product visible to the other device.
[PIN Code Input]	Change the PIN code for Bluetooth connection. The default PIN code is "0000". 1 Touch [0] to [9] to input the pin code (up to 8 digits). 2 Touch .
[Device Information]	Displaying the device name and address of this product.
[Bluetooth Memory Clear]	Touch [Clear] then [OK] to clear the Bluetooth memory.
[Sound Quality Settings] [Quality] [Connectivity]	Select [Quality] to prioritize the Bluetooth sound quality. Select [Connectivity] to prioritize the Bluetooth connection.

Switching the connected Bluetooth device

After registering and connecting the Bluetooth devices to this product, you can switch among the devices using the switch devices key in the phone function and some audio sources.

- You can register up to five Bluetooth devices on this product (page 24).
- You can connect one of the registered devices to this product. In cases where the registered device is equipped with a phone function, a total of two devices can be connected at the same time when using the phone function. If two of the five registered devices are already connected, you can connect the remaining third device to use the audio function only from the switch devices key on the audio source screen.
- The icon for the cellular phone currently being used is displayed on the phone menu screen. If you connect two cellular phones to this product at the same time, you can switch between the cellular phones using the switch devices key. The contents of the phone menu are memorized for each connected cellular phone (page 26).
- The switch devices key will appear for some audio sources. The audio source may automatically switch to another source depending on the selected device.

Hands-free phoning

To use this function, you need to connect your cellular phone to this product via Bluetooth in advance (page 24).







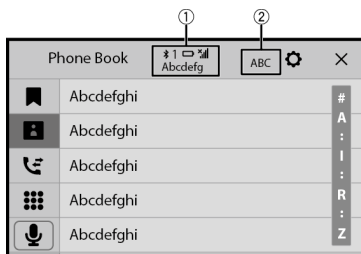

CAUTION

For your safety, avoid talking on the phone as much as possible while driving.

Making a phone call

- 1 Touch  then swipe left on the screen.
- 2 Touch [Phone].
The phone menu screen appears.
- 3 Touch one of the call icons on the phone menu screen.



①	<p>The following items are displayed.</p> <ul style="list-style-type: none"> • Name of the current cellular phone • List number of the current cellular phone • Reception status of the current cellular phone • Battery status of the current cellular phone <p>TIP</p> <p>If you connect two cellular phones to this product at the same time, you can switch between the cellular phones using the switch devices key.</p> <p>NOTE</p> <p>When you switch the connected cellular phone, the following items are also switched:</p> <ul style="list-style-type: none"> • Widgets on the home menu screen • Favorite icons on the home menu screen • Browser bookmarks • Favorite sports teams • Notification settings • [Background] settings for the home menu screen and AV operation screen <p>For details, refer to CarAVAssist (page 41).</p>
②	<p>Switches the search language to English or system language.</p> <p>NOTE</p> <p>It may not appear depending on the system language setting.</p>
	<p>Using the preset dial lists (page 28)</p>
	<p>Using phone book</p> <p>Select a contact from the phone book. Touch the desired name on the list then select the phone number.</p> <p>TIPS</p> <ul style="list-style-type: none"> • The contacts on your phone will be automatically transferred to this product. • Update the phone book manually. <p>NOTES</p> <ul style="list-style-type: none"> • [Visibility] of the [Bluetooth] screen should be on (page 25). • If two cellular phones are automatically connected to this product with the Bluetooth device auto connect function, the phone book of the first phone is displayed.
	<p>Using call history</p> <p>Make a phone call from the received call , dialed call , or missed call .</p>
	<p>Direct phone number input</p> <p>Touch the number keys to enter the phone number then touch  to make a call.</p>

► **To end the call**

- 1 Touch .

Using the preset dial lists

► Registering a phone number

You can easily store up to six phone numbers per device as presets.

1 Touch  then swipe left on the screen.

2 Touch [Phone].

3 Touch  or .

On the [Phone Book] screen, touch the desired name to display the contact's phone number.

4 Touch .

► Dialing from the preset dial list

1 Touch  then swipe left on the screen.

2 Touch [Phone].

3 Touch .

4 Touch the desired entry on the list to make a call.

The dial screen appears and dialing starts.

► Deleting a phone number

1 Touch  then swipe left on the screen.

2 Touch [Phone].

3 Touch .

4 Touch .



5 Touch [Yes].

Receiving a phone call

1 Touch  to answer the call.

Touch  to end the call.

TIPS

- Touch  while getting a call waiting, switch to the talking person.
- Touch  while getting a call waiting to reject the call.

NOTE



When two phones are connected at the same time, if an incoming call is received on the second phone while you are talking on the first phone, the dial confirmation screen for the second phone will be displayed.

Voice recognition function (for iPhone)

By connecting your iPhone to this product, you can use the voice recognition function (Siri Eyes Free Mode) on this product.



NOTE

When an iPhone is used, Siri Eyes Free Mode is available with this product.



- 1 Touch  then swipe left on the screen.
- 2 Touch [Phone].
- 3 Touch .

The voice recognition function launches and the voice control screen appears.

TIPS

- You can also launch the voice recognition function by touching  button.
- If two cellular phones are automatically connected to this product with the Bluetooth device auto connect function, the voice recognition function (Siri Eyes Free Mode) will be set on the first phone.
- If you want to use the voice recognition function (Siri Eyes Free Mode) on another connected iPhone, touch  with numbered to the other iPhone. The iPhone that you switch to will be set as the current device.



Phone settings

- 1 Touch  then swipe left on the screen.
- 2 Touch  then .
- 3 Touch [Bluetooth Settings].

Menu Item	Description
[Auto Answer] [On] [Off]	Select [On] to answer an incoming call automatically.
[Ring Tone] [On] [Off]	Select [Off] to use the ring tone of the paired device, or select [On] to use the ring tone of this unit.
[Invert Name]	Select [Yes] to change the order of the first and last names in the phone book.

Setting the private mode

During a conversation, you can switch to private mode (talk directly on your cellular phone).

1 Touch  or  to turn private mode on or off.

NOTES

- If two cellular phones are connected to this product and the first phone is set to private mode, you can receive incoming calls on the second phone while maintaining the call in progress on the first phone.
- When two cellular phones are connected to this product and private mode of the first phone is turned off, if an incoming call on the second phone is answered while a call is in progress on the first phone or while dialing or receiving a call on the first phone, the call, dialing, or receiving on the first phone is ended.

Adjusting the other party's listening volume

This product can be adjusted to the other party's listening volume.

1 Touch  to switch between the three volume levels.

Notes for hands-free phoning

► General notes

- Connection to all cellular phones featuring Bluetooth wireless technology is not guaranteed.
- The line-of-sight distance between this product and your cellular phone must be 10 meters or less when sending and receiving voice and data via Bluetooth technology.
- With some cellular phones, the ring sound may not be output from the speakers.
- If private mode is selected on the cellular phone, hands-free phoning may be disabled.

► Registration and connection

- Cellular phone operations vary depending on the type of cellular phone. Refer to the instruction manual that came with your cellular phone for detailed instructions.
- When phone book transfer does not work, disconnect your phone and then perform pairing again from your phone to this product.

► Making and receiving calls

- You may hear a noise in the following situations:
 - When you answer the phone using the button on the phone.
 - When the person on the other end of the line hangs up the phone.
- If the person on the other end of the line cannot hear the conversation due to an echo, decrease the volume level for hands-free phoning.
- With some cellular phones, even after you press the accept button on the cellular phone when a call comes in, hands-free phoning may not be performed.

- The registered name will appear if the phone number is already registered in the phone book. When multiple names are registered for the same phone number, the names are displayed in the same order as in the phone book.

► **The received call and dialed number histories**

- You cannot make a call to the entry of an unknown user (no phone number) in the received call history.
- If calls are made by operating your cellular phone, no history data will be recorded in this product.

► **Phone book transfers**

- If there are more than 1 000 phone book entries on your cellular phone, not all entries may download completely.
- Depending on the phone, this product may not display the phone book correctly.
- If the phone book in the phone contains image data, the phone book may not be transferred correctly.
- Depending on the cellular phone, phone book transfer may not be available.

Bluetooth audio

Before using the Bluetooth audio player, register and connect the device to this product (page 24).

NOTES

- Depending on the Bluetooth audio player connected to this product, the available operations with this product may be limited to the following two levels:
 - A2DP (Advanced Audio Distribution Profile): Only playing back songs on your audio player is possible.
 - A2DP and AVRCP (Audio/Video Remote Control Profile): Playing back, pausing, selecting songs, etc., are possible.
- Depending on the Bluetooth device connected to this product, the available operations with this product may be limited or differ from the descriptions in this manual.
- While you are listening to songs on your Bluetooth device, refrain from operating the phone function as much as possible. If you try operating, the signal may cause noise for song playback.
- When you are talking on the Bluetooth device connected to this product via Bluetooth, it may pause playback.

1 Touch  then swipe left on the screen.

2 Touch  then .

The system setting screen appears.

3 Touch [AV Source Settings].

4 Confirm that [Bluetooth Audio] is turned on.

5 Touch  then swipe left on the screen.









The source/application screen appears.

- 6 Touch [Bluetooth Audio].
The Bluetooth audio playback screen appears.

Basic operation

Bluetooth audio playback screen







①	Track number indicator
 	Switches between playback and pause.
 	Skips files forward or backward.
	Sets a repeat play range.
	Switches between random and normal file playback order.
	Selects a file or folder from the list to playback. NOTE This function is available only when the AVRCP version of the Bluetooth device is 1.4 or higher.
	Switches among the Bluetooth devices when the devices are connected to this product via Bluetooth (page 25).

Wi-Fi®

By connecting this unit to a Wi-Fi network, you can browse the Internet and use Apple CarPlay via the wireless connection.

Wi-Fi connection

- 1 Turn on the Wi-Fi function on the device.
- 2 Touch  then swipe left on the screen.
- 3 Touch  then .
- 4 Touch [Wi-Fi Settings: Hotspot].
- 5 Set [Wi-Fi] to [On].
- 6 Touch [Hotspot setting].
- 7 Touch .
The available Wi-Fi networks appear on the list.
- 8 Touch one of the listed Wi-Fi networks on the list.
The network password input screen appears if a password is required.
- 9 Input the network password then touch [Connection].



Important

When you connect this unit to the Internet via Wi-Fi for the first time, the Internet Communication Service the Terms of Use and Privacy Policy is displayed. To use the Internet service, you need to accept the policy. Otherwise, most of the applications that use the Internet are not available. You can select to accept or withdraw from the policy at any time in [Terms of Use / Privacy] (page 110).

TIP





You can also connect easily to Wi-Fi via WPS (page 35).

Setting the Wi-Fi access point

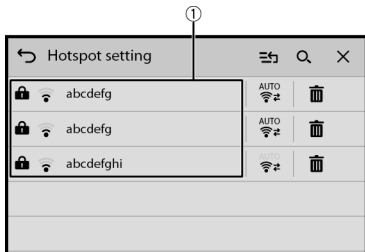
- 1 Touch  then swipe left on the screen.
- 2 Touch  then .
- 3 Touch [Wi-Fi Settings: Hotspot].
- 4 Touch [Hotspot setting].

Access point setting screen



①	Available network SSIDs Touch to connect selected network.
	Automatic connection status Touch to switch between the network automatically or manually.
	Network connection priority Drag the network upward to prioritize the connection by touching  .
	Searches for existing networks. Touch to go to Adding access point screen (page 34).
	Deletes the networks.

Adding access point screen

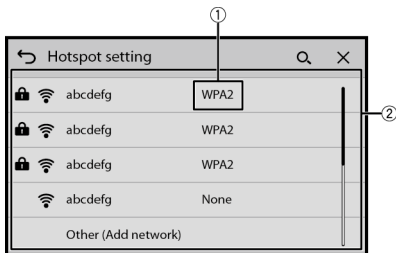



①	Wi-Fi network type
---	---------------------------

②	<p>Connects Wi-Fi network. Touch to select desired network then enter the password if required.</p> <p>TIP If you want to connect to a network that is not listed on the screen, touch [Other (Add network)] and enter the required information.</p>
	<p>Searches again for existing networks.</p>



WPS Wi-Fi connection

You can connect easily to a Wi-Fi network, if WPS (Wi-Fi Protected Setup™) is available on the connected device.



► WPS connection with the push button

- 1 Touch  then swipe left on the screen.
- 2 Touch  then .
- 3 Touch [Wi-Fi Settings: Hotspot].
- 4 Touch [Easy setup].
- 5 Touch [Press the WPS button on the unit and the hotspot to connect them via Wi-Fi].

► WPS connection with PIN code

- 1 Touch  then swipe left on the screen.
- 2 Touch  then .
- 3 Touch [Wi-Fi Settings: Hotspot].
- 4 Touch [Easy setup].
- 5 Touch [Enter PIN code to connect to the hotspot].
- 6 Input the displayed PIN code from the device to be connected.

Wi-Fi settings

- 1 Touch  then swipe left on the screen.
- 2 Touch  then .
- 3 Touch [Wi-Fi Settings: Hotspot].

NOTE

This setting is available only when you stop your vehicle in a safe place and apply the parking brake.



The menu items vary according to the source/application.

Menu Item	Description
[Wi-Fi] [On] [Off]	Switch Wi-Fi connection on or off.
[Hotspot setting]	Set up the Wi-Fi access point (page 33).
[Easy setup]	Set up the Wi-Fi connection via WPS access (page 35).
[MAC Address]	Displays the MAC address.
[IP Address]	Displays the IP address.

Access point via Wi-Fi

This unit can be an access point of the infrastructure mode network. Use this unit as an access point to use Apple CarPlay or Android Auto via Wi-Fi network.

Access point settings

- 1 Touch  then swipe left on the screen.
- 2 Touch  then .
- 3 Touch [Wireless Settings: Smartphone].

Menu Item	Description
[Access point] [On] [Off]	Select [On] to enable the access point of the infrastructure mode network.
[Device Information]	Displays this unit's infrastructure mode network information.
[Password]	Displays the infrastructure mode network password.
[Password reset]	Touch [OK] to reset the infrastructure mode network password.

Wi-Fi audio

Before using the Wi-Fi audio player, connect the device to this product via Apple CarPlay™ (page 65) or Android Auto wirelessly (page 68).

- 1 Touch  then swipe left on the screen.
- 2 Touch [Apple CarPlay] or [Android Auto] instead of [Wi-Fi Audio].

The Wi-Fi audio playback screen appears.

NOTES

- [Wi-Fi Audio] is displayed as [Android Auto] when the Android Auto is in use.
- [Wi-Fi Audio] is displayed as [Apple CarPlay] when the Apple CarPlay is in use.

Basic operation

Wi-Fi audio screen (Example: Apple CarPlay)

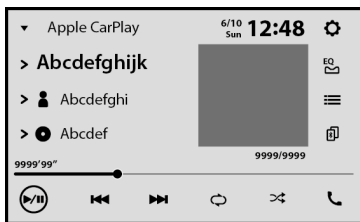

Wi-Fi audio with Apple CarPlay operation is same as the iPod® source function. For details of the operation, refer to the iPhone operation (page 60).

Browser

The browser enables you to browse registered websites using CarAVAssist.

WARNING

- Do not attempt to operate the web browser while driving. Make sure to pull off the road and park your vehicle in a safe location before attempting to use the controls on the web browser.
- When you use the browser, do not enter your important information such as credit card information, bank account information and personal information.
- When you use the browser, do not install software or programs that Pioneer is not involved with. If you install such software or programs, mechanical trouble may occur with this unit, or your entered information and the personal information registered in this unit may be put at risk.

Using the browser

Important

- To use the browser function, you may need to connect this unit to the Internet via a Wi-Fi network.
- To use the browser function, you need to register webpage URLs as your favorite webpages on CarAVAssist, then import them to this unit in advance (page 42).
- To use the browser function, you need to accept the Internet Communication Service the Terms of Use and Privacy Policy (page 110).
- The browser may not be able to access or display some webpages, and some characters may not be displayed properly.
- It may take some time to display webpages.
- The browser may display pages slowly depending on the video resolution.
- The browser may not be able to play some types of video and audio.
- The browser does not display content that uses plug-ins, such as PDF.
- The browser does not support some functions such as downloading files.

Starting procedure

- 1 Touch  then swipe left on the screen.
- 2 Touch [Browser].
- 3 Touch your desired registered website icon.

Web browser screen

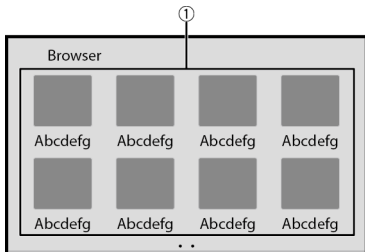

①

Available website thumbnails

Touch to go to the selected website.

TIP

Swipe left/right to switch between registered webpage list.

Website screen

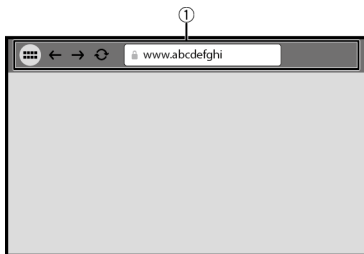

①

Browser toolbar

To display the toolbar, swipe down from the top of the screen.



Returns to the web browser screen.



Displays the previous page.



Displays the next page.



Refreshes the page.

NOTE

When using the browser while Apple CarPlay or Android Auto is in operation, the browser is displayed on the connected rear monitor only when the browser is displayed on the main monitor. Otherwise, a black screen is displayed on the connected rear monitor.

CarAVAssist

CarAVAssist is an application that allows you to configure and transfer various settings of this unit and register URLs as favorites so that you can browse them using this unit's web browser. You can also update this unit's firmware wirelessly by using this application.

Before you start

WARNING

Do not attempt to operate the application while driving. Make sure to pull off the road and park your vehicle in a safe location before attempting to use the controls on the application.

For iPhone users

This function is compatible with iOS 12.0 or later.
You can download CarAVAssist on the App Store®.



For smartphone (Android) users

This function is compatible with devices that have Android OS 6.0 or later installed.
You can download CarAVAssist on the Google Play Store.



What kind of functions does the application have?

Promoting the use of the unit

The interface of the unit can be changed by using your iPhone/smartphone (Android).

Examples

- Customizing the home menu screen including the widget
- Customizing the wallpaper
- Registering your favorite webpage URLs to your bookmarks to see those webpages on the web browser



- Registering your favorite teams to receive information about them on the sports application of the unit
 - Organizing notifications on your smartphone (Android) for displaying on the unit
 - Downloading the latest firmware
- For details, refer to "Help" in the CarAVAssist application.



Transferring the data

- 1 Connect your iPhone or smartphone with CarAVAssist installed on it to this product via Bluetooth (page 24).
- 2 Open CarAVAssist on the connected iPhone or smartphone then touch the connection button on the top menu screen of the application.

NOTE

When the Bluetooth connection is disconnected or the main unit is turned off, perform step 1 and step 2 again after re-establishing the Bluetooth connection or turning on the main unit.



- 3 Touch  then swipe left on the screen.
- 4 Touch .
- 5 Touch one of the transfer modes.

	iPhone/smartphone to main unit
	Main unit to iPhone/smartphone

Updating the firmware wirelessly

CAUTION

- Never turn this product or your iPhone/smartphone off while the firmware is being updated.
- You can only update the firmware when the vehicle is stopped and the parking brake is engaged.
- You cannot update the old firmware version once the latest firmware is updated.

- 1 Download the firmware update files into your iPhone or smartphone through CarAVAssist.
- 2 Connect your CarAVAssist-installed iPhone or smartphone to this unit via Wi-Fi network (page 33).
- 3 Touch  then swipe left on the screen.
- 4 Touch  then .
- 5 Touch [System Information].

6 Touch [Firmware Update].

7 Touch [CarAVAssist].

Follow the on-screen instructions to finish updating the firmware.

NOTES

- This product will reset automatically after the firmware update is completed if the update is successful.
- If an error message appears on the screen, touch the display and perform the above steps again.

Source/application

Supported source and application

You can play or use the following sources or application with this product.

- HD Radio™ Technology/Radio (page 47)
- USB (page 53)

The following sources or applications can be played back or used by connecting an auxiliary device.

- iPhone® (page 60)
- Bluetooth audio (page 31)
- Wi-Fi audio (page 36)
- SiriusXM® Satellite Radio (page 81)
- AUX (page 90)
- HDMI (page 89)
- Car Sources (iDatalink (page 93))
- Car Features (iDatalink (page 93) or Metra Axxess (page 98))
- Browser (page 38)
- Sports (page 71)
- Weather (page 72)
- Amazon Alexa (page 74)
- Camera view (page 92)



Displaying the source/application list screen

- 1 Touch  then swipe left on the screen.

The source/application screen appears.

Source/application list screen





①	<p>Source list Touch to see the selected source.</p> <p>TIP Selecting [Power OFF] will turn off most of the functions on this unit. The [Power OFF] mode is released in the following cases:</p> <ul style="list-style-type: none"> • Footage from the rear view camera is input when the vehicle is in reverse. • A button on this unit is touched. • The ignition switch is turned off (ACC OFF), then turned on (ACC ON).
②	<p>Connected Wi-Fi network Touch to go to the Wi-Fi settings (page 35).</p>
③	<p>Connected mobile device Touch to go to the preset list screen in the hands-free phone when a device is connected with this unit via Bluetooth. Touch to start searching or go to the device select screen, when the device is not connected.</p> <p>NOTE When Apple CarPlay or Android Auto is activated, the device select screen appears even if a device is connected with this unit.</p>
④	<p>Application list Touch to see the selected application.</p>
	<p>Displays the next items in the list if there are more.</p>
	<p>Displays the previous screen.</p>

Displaying the AV operation screen

- 1 Touch  then touch the AV operation key.
The AV operation screen appears.



①	Displays the source/application list.
	Settings (page 101) and Favorite menu (page 119)
	Selects or customizes the equalizer curve (page 114).
	Hands-free phoning (page 26)

Selecting a source/an application

NOTE

[Source OFF] is only available for AV sources.

Source/application selection screen

- 1 Touch  then swipe left on the screen.
- 2 Touch the source/application icon.
When you select [Source OFF], the AV source is turned off.



Source/application list

- 1 Touch  when the AV source is in use.
- 2 Touch the source/application key.
When you select [Source OFF], the AV source is turned off.

Rearranging the display order of source

NOTE

This function is available only when you stop your vehicle in a safe place and apply the parking brake.

- 1 Touch  when the AV source is in use.
- 2 Touch .
- 3 Drag the source/application key to the desired position.

HD Radio™ Technology/ Radio

HD Radio™

8600NEX

7600NEX

6600NEX

4660NEX

Radio

4600NEX

About HD Radio stations

HD Radio stations offer high quality audio and data services. HD Radio stations are brought to you by your local FM or AM stations.

HD Radio stations feature the following:

- High quality audio
- FM multicasting
- Data service

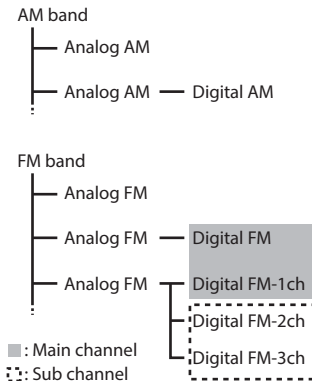

Digital Sound)

Digital, CD-quality sound. HD Radio Technology enables local radio stations to broadcast a clean digital signal. AM sounds like today's FM and FM sounds like a CD.

PSD

Program Service Data: Contributes to the superior user experience of HD Radio Technology. Presents song name, artist, station IDs, HD2/HD3 Channel Guide, and other relevant data streams.

HD2/HD3

Adjacent to traditional main stations are extra local FM channels. These HD2/HD3 Channels provide new, original music as well as deep cuts into traditional genre.

Artist Experience

Visual information related to content being played on your HD Radio receiver, such as Album Art, historical photographs, still art from live broadcasts, among other related content.

Starting procedure

- 1 Touch  then swipe left on the screen.
- 2 Touch [HD Radio] or [Radio].
The HD Radio or radio screen appears.

Basic operation

HD Radio, Radio screen

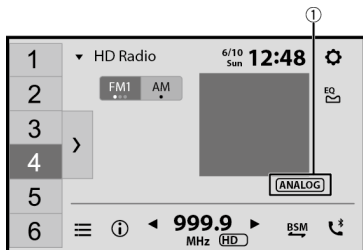

	HD Radio indicator and signal type indicator
	Recalls the preset channel stored to a key from memory.
	Stores the current broadcast frequency to a key.
	Displays the preset channel list. Select an item on the list ([1] to [6]) to switch to the preset channel.
	Selects the FM1, FM2, FM3 or AM band.
	Performs BSM (best stations memory) function (page 50).
	Displays area radio stations list (page 50).
	Manual tuning
	Seek tuning or non stop seek tuning Releasing the key in a few seconds skips to the nearest station from the current frequency. Keep holding the key for long seconds to perform non stop seek tuning.
	Switches the text display between the main channel and sub channels.

Storing the strongest broadcast frequencies (BSM)

The BSM (best stations memory) function automatically stores the six strongest broadcast frequencies under the preset channel keys [1] to [6].

NOTES

- Storing broadcast frequencies with BSM may replace those you have already saved.
- Previously stored broadcast frequencies may remain stored if the number of frequencies stored has not reached the limit.

1 Touch and hold to begin search.

The six strongest broadcast frequencies will be stored under the preset channel keys in the order of their signal strength.

To cancel the storage process

1 Touch [Cancel].

Area radio stations list

This unit displays the radio stations that are available at your current location.

1 Touch .

Important

To use the area radio stations list function, you may need to connect this unit to the Internet via a Wi-Fi network and set [Suggestions] (page 101) to [On].

Limitations:

Depending on the availability of the Internet, you may not be able to receive the area radio stations list service.

Area radio stations list screen





①

Available radio stations

Touch to tune in to the selected radio station.

Radio settings

- 1 Touch  then swipe left on the screen.
- 2 Touch  then .
- 3 Touch [AV Source Settings].
- 4 Touch [Radio settings].

The menu items vary according to the source.

Menu Item	Description
[Blending]* [On] [Off]	Switches to the analog broadcast of the same frequency level automatically when reception of a digital broadcast becomes weak. Select [Off] to receive only an analog signal.
[Seek]*	Select the method of seek tuning.
[Seek All]	Seeks stations from both analog and digital broadcasting.
[Seek HD]	Only seeks stations from digital broadcasting.

Menu Item	Description
[Local] [Off] FM: [Level1] [Level2] [Level3] [Level4] AM: [Level1] [Level2]	Local seek tuning allows you to only tune into radio stations with sufficiently strong signals. NOTES <ul style="list-style-type: none">• [Level4] for FM and [Level2] for AM are available only with the stations with the strongest signals.• This setting is available only when [HD Radio] is selected as the source.

* DMH-WT8600NEX, DMH-WT7600NEX, DMH-WC6600NEX, DMH-W4660NEX

USB

Plugging/unplugging a USB storage device

You can play audio, video, or still image files stored in a USB storage device.

Plugging a USB storage device

1 Plug a USB Type-C® storage device into the USB Type-C cable.

TIP

When you use a USB Type-A storage device, use a USB Type-C to USB Type-A adaptor (supplied) for plugging.

NOTES

- This product may not achieve optimum performance with some USB storage devices.
- Connection via a USB hub is not possible.
- A USB Type-C cable is required for connection.
- The supplied USB Type-C cable and the adaptor are for connecting a USB storage device to this unit only. Do not use the cable and the adaptor for other products or purposes.

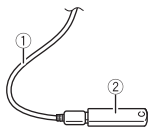

①	USB Type-C cable
②	USB Type-C storage device

Unplugging a USB storage device

1 Pull out the USB Type-C storage device from the USB Type-C cable.

NOTES

- Check that no data is being accessed before pulling out the USB storage device.
- Turn off (ACC OFF) the ignition switch before unplugging the USB storage device.

Starting procedure

- 1 Touch  then swipe left on the screen.
- 2 Plug the USB Type-C storage device into the USB Type-C cable (page 53).
- 3 Touch [USB].
Playback is performed in order of folder numbers. Folders are skipped if they contain no playable files.

Basic operation

TIP

You can set the screen size for the video and image files (page 120).

Audio source

Audio source screen 1



①

Displays the link search screen.

Touch the song to play back followed by touching the song information, after switching to Music Browse mode (page 56).

TIP

If you touch the artwork, the list of songs in the album is displayed.

NOTE





This function is available for the USB storage device only.



Switches between playback and pause.







Skips files forward or backward.

	Sets a repeat play range for all files/the current folder/the current file.
	Switches between random and normal file playback order.
	Displays the hidden function bar. TIP You can also display the hidden function bar by flicking the bar from the right to the left.
	Switches the following media file types. [Music]: Audio files [Video]: Video files [Photo]: Image files
	Selects a file from the list. Touch a file on the list to playback. TIP Touching a folder on the list shows its contents. You can play a file on the list by touching it. NOTE When you play audio files stored in a USB storage device, you can search for a file using Music Browse (page 56).

Audio source screen 2



	Displays the hidden function bar. TIP You can also display the hidden function bar by flicking the bar from the left to the right.
 	Selects the previous folder or the next folder.

	Constructs the database for using the Music Browse mode (page 56).
	Switches the current music information display.

► Selecting a file using Music Browse mode

You can select files to play back using the category list if the files contain tag information.

NOTES

- This function is available for the USB storage device only.
- Music Browse mode cannot be held once the power is turned off.

1 Touch to create a database.

Music Browse mode will be available after the database has been created.

2 Touch .

3 Touch the desired category to display the file list.

4 Touch the item.

Refine the item until the desired song title or file name is displayed on the list.

5 Touch the desired song title or file name to play back.

If the selection made with Music Browse has been canceled, you can switch to Music Browse mode again by touching the [Tag] tab on the file/folder list screen and touching the desired track.

TIP

Once the database is created in this unit, there is no need to create the database again as long as the same contents are saved. To enter the Music Browse mode directly, touch  and then touch [Tag] before selecting the song.











Video source

CAUTION

For safety reasons, video images cannot be viewed while your vehicle is in motion. To view video images, stop in a safe place and apply the parking brake.

Video source screen



①	<p>Hides the touch panel keys. To display the keys again, touch anywhere on the screen.</p>
	<p>Switches between playback and pause.</p>
	<p>Performs fast reverse or fast forward. Touch again to change the playback speed.</p>
	<p>Stops playback. Touch again to start from the beginning next time.</p>
	<p> Performs frame-by-frame playback.</p> <p> Performs slow-motion playback.</p>
	<p>Sets a repeat play range for all files/the current folder/the current file.</p>
	<p>Switches the audio language.</p>
	<p>Switches the following media file types. [Music]: Audio files [Video]: Video files [Photo]: Image files</p>
	<p>Selects a file from the list. Touch a file on the list to playback.</p> <p>TIP Touching a folder on the list shows its contents. You can play a file on the list by touching it.</p>

	Skips files forward or backward.
---	---







Still image source



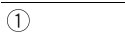

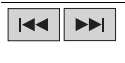
TIP

Image files are not displayed in the rear display.

Still image screen



	Hides the touch panel keys. To display the keys again, touch anywhere on the screen.
	Switches between playback and pause.
	Skips files forward or backward.
	Selects the previous folder or the next folder.
	Saves the current images as the wallpaper. Touch the following items to overwrite the image. [As AVScreen]: Saves the image as the wallpaper for the AV screen. [As HomeScreen]: Saves the image as the wallpaper for the home menu screen. [As Both]: Saves the image as the wallpaper for both the AV screen and home menu screen. NOTE If you save the new image, the current wallpaper is overwritten except for the preset image.
	Rotates the displayed picture 90° clockwise.

	Sets a repeat play range for all files/the current folder.
	Plays all files in the current repeat play range or does not play them in random order.
	Switches the following media file types. [Music]: Audio files [Video]: Video files [Photo]: Image files
	Selects a file from the list. Touch a file on the list to playback. TIP Touching a folder on the list shows its contents. You can play a file on the list by touching it.

iPhone®

NOTE

iPhone may be referred to as iPod in this manual.

Connecting your iPhone

When connecting an iPhone to this product, the settings are automatically configured according to the device to be connected. For details of the compatibility, refer to Compatible iPhone models (page 134).

- 1 **Connect your iPhone.**
 - iPhone via USB or Bluetooth
- 2 Touch  then swipe left on the screen.
- 3 Touch [iPod].

NOTES







- For USB connection, refer to the Installation Manual.
- For Bluetooth connection, see page 24.

Basic operation

Audio source

Audio source screen



<p>①</p>	<p>Displays the link search screen. Select a song from the list related to the song currently playing.</p> <p>TIP If you touch the artwork, the list of songs in the album is displayed.</p> <p>NOTE This function is not available while playing Apple Music® Radio.</p>
	<p>Switches between playback and pause.</p>
	<p>Skips files forward or backward.</p>
	<p>Sets a repeat play range for all in the selected list/the current song.</p>
	<p>Plays songs within the selected list/album randomly.</p>
	<p>Switches among connected devices.</p>
	<p>Selects a song from the list. Touch the category then the title of the list to playback of the selected list.</p> <p>TIPS</p> <ul style="list-style-type: none"> • If you use English as the system language, the alphabet search function is available. Touch the initial search bar to use this function. • When you touch Apple Music Radio station in the list screen, Apple Music Radio screen appears (page 62). <p>NOTE Only 15 000 songs in the iPhone are available in the list if the iPhone has more than 15 000 songs. Available songs depend on the iPhone.</p>

iPhone application screen

You can also play and control the music application in your iPhone in the iPhone source.

iPhone application screen

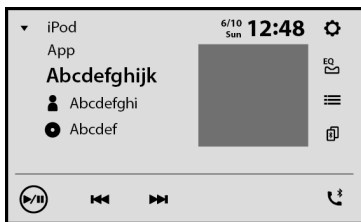

Switches between playback and pause.



Skips files forward or backward.

Apple Music Radio source



Important

Apple Music Radio may not be available in your country or region. For details about Apple Music Radio, visit the following site: <https://www.apple.com/music/>

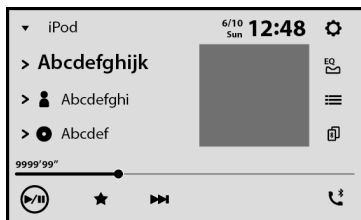
Apple Music Radio screen



Switches between playback and pause.

	<p>Displays the pop-up menu for Apple Music Radio.</p> <ul style="list-style-type: none">• Touch [Play More Like This] to play back songs similar to the current song.• Touch [Play Less Like This] to set it not to play back the current song again.• Touch [Add to iTunes Wish List] to add the current song to the iTunes® wish list. <p>NOTE</p> <p>This function may not be used depending on your Apple Music account status.</p>
	<p>Skips tracks forward.</p>

Apple CarPlay™

You can operate iPhone applications with finger gestures such as tapping, dragging, scrolling, or flicking on the screen of this product.

Compatible iPhone models

For details about compatibility of iPhone models, refer to the following website.
<https://www.apple.com/ios/carplay>

NOTES

- The compatible finger gestures vary depending on the application for the iPhone.
- To use the Apple CarPlay function, first turn off the Amazon Alexa or CarAVAssist function.

WARNING

Certain uses of the iPhone may not be legal while driving in your jurisdiction, so you must be aware of and obey any such restrictions. If in doubt as to a particular function, only perform it while the car is parked. No feature should be used unless it is safe to do so under the driving conditions you are experiencing.

Using Apple CarPlay

Important

Apple CarPlay may not be available in your country or region.

For details about Apple CarPlay, visit the following site:



<https://www.apple.com/ios/carplay>

- The content and functionality of the supported applications are the responsibility of the App providers.
- In Apple CarPlay, usage is limited while driving, with availability of functions and content determined by the App providers.
- Apple CarPlay allows access to applications other than those listed that are subject to limitations while driving.
- PIONEER IS NOT RESPONSIBLE AND DISCLAIMS LIABILITY FOR THIRD PARTY (NON-PIONEER) APPS AND CONTENT, INCLUDING WITHOUT LIMITATION ANY INACCURACIES OR INCOMPLETE INFORMATION.
- Before using Apple CarPlay, make sure the GPS antenna and speed cable are properly connected and installed, and the unit angle is properly set. For details on the installation, refer to the Installation Manual.

Setting the driving position

To achieve optimum usability of Apple CarPlay, set the driving position setting correctly according to the vehicle. The setting will be applied the next time an Apple CarPlay compatible device is connected to this product.

- 1 Touch  then swipe left on the screen.

- 2 Touch  then .

The communication setting screen appears.

- 3 Touch [Driving Position].
- 4 Select the item.
 - [Left]
Select for a left-hand drive vehicle.
 - [Right]
Select for a right-hand drive vehicle.

Starting procedure

Wired connection



- 1 Connect an Apple CarPlay compatible device to this unit via USB.
- 2 Touch the Apple CarPlay icon.
The Apple CarPlay home screen appears.

TIP

You can also start the Apple CarPlay from the source/application list screen by swiping the screen to the left on the home menu screen.

Wireless connection

Before using Apple CarPlay wirelessly, turn on the Bluetooth function on the iPhone.

- 1 Turn on the Wi-Fi function (page 36).
- 2 Touch  then .

TIP

You can skip the step 2 by touching and holding  button.

- 3 Touch .

The available devices appear on the list.

NOTE

The unit cannot detect the device unless the Bluetooth or Apple CarPlay setting menu is displayed on the iPhone screen.

- 4 Touch the desired device on the screen.
The unit configures the connection then starts the application.

TIP

If the device that you want to connect does not appear, touch  on the screen again. You can also start Apple CarPlay with the desired device by opening the Bluetooth or Apple CarPlay setting menu while displaying the device search or device list screen.

TIP

You can use Siri function by touching  button once Apple CarPlay is activated.

NOTES

- For details on USB connection, refer to the Installation Manual.
- If an Apple CarPlay compatible device has been connected and another screen is displayed, touch Apple CarPlay icon on the source/application screen to display the Application menu screen.
- The Bluetooth connection with the Apple CarPlay compatible device will be terminated automatically if Apple CarPlay is turned on. While Apple CarPlay is turned on, only a Bluetooth audio connection will be possible for devices other than the device connected via Apple CarPlay.
- Hands-free phoning via Bluetooth wireless technology is not available while Apple CarPlay is on. If Apple CarPlay is turned on during a call on a cellular phone other than an Apple CarPlay compatible device, the Bluetooth connection will be terminated after the call ends.

Adjusting the volume

You can adjust the guidance volume separately from the main sound volume when Apple CarPlay is used.

1 While Apple CarPlay is activated, touch VOL (+/-).

The volume menu will be displayed on the screen.

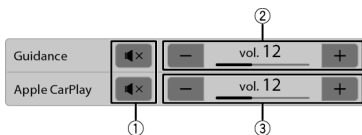

①	Touch to mute. Touch again to cancel mute.
②	Touch [+] / [-] to adjust the guidance volume.
③	Displays the main sound volume. To adjust the main sound volume, touch VOL (+/-) on the unit or touch [+] / [-].

NOTE

The volume menu is displayed for four seconds. If the menu disappears, touch VOL (+/-) again. The menu reappears.

Android Auto™

You can operate Android applications with finger gestures such as tapping, dragging, scrolling, or flicking on the screen of this product.

Compatible Android devices

For details about compatibility of Android models, refer to the following website.
<https://support.google.com/androidauto>

NOTES

- [USB MTP] is set to [Off] to use Android Auto (page 102).
- The compatible finger gestures vary depending on the application for the smartphone.
- To use the Android Auto function, first turn off the Amazon Alexa function.

WARNING

Certain uses of the smartphone may not be legal while driving in your jurisdiction, so you must be aware of and obey any such restrictions. If in doubt as to a particular function, only perform it while the car is parked. No feature should be used unless it is safe to do so under the driving conditions you are experiencing.

Using Android Auto



Important

Android Auto may not be available in your country or region.
For details about Android Auto, please refer to the Google™ support site:
<https://support.google.com/androidauto>

- The content and functionality of the supported applications are the responsibility of the App providers.
- In Android Auto, usage is limited while driving, with availability of functions and content determined by the App providers.
- Android Auto allows access to applications other than those listed that are subject to limitations while driving.
- PIONEER IS NOT RESPONSIBLE AND DISCLAIMS LIABILITY FOR THIRD PARTY (NON-PIONEER) APPS AND CONTENT, INCLUDING WITHOUT LIMITATION ANY INACCURACIES OR INCOMPLETE INFORMATION.
- Before using Android Auto, make sure the GPS antenna and speed cable are properly connected and installed, and the unit angle is properly set. For details on the installation, refer to the Installation Manual.

Setting the driving position

To achieve optimum usability of Android Auto, set the driving position setting correctly according to the vehicle. The setting will be applied the next time an Android Auto compatible device is connected to this product.

- 1 Touch  then swipe left on the screen.
- 2 Touch  then .

The communication setting screen appears.

- 3 Touch [Driving Position].
- 4 Select the item.
 - [Left]
Select for a left-hand drive vehicle.
 - [Right]
Select for a right-hand drive vehicle.



Starting procedure

Wired connection

- 1 Connect an Android Auto™ compatible device to this unit via USB.
- 2 Touch the Android Auto icon.
The Android Auto home screen appears.

Wireless connection

Before using Android Auto wirelessly, turn on the Bluetooth function on the Android device.

- 1 Turn on the Wi-Fi function (page 36).
- 2 Touch  then .

TIP

You can skip the step 2 by touching and holding  button.

- 3 Touch .

The available devices appear on the list.

NOTE

The unit cannot detect the device unless the Bluetooth setting menu is displayed on the smartphone screen.

- 4 Touch the desired device on the screen.
The unit configures the connection then starts the application.

TIP

If the device that you want to connect does not appear, touch  on the screen again.

TIP

You can use voice recognition function by touching  button once Android Auto is activated.

NOTES

- For details on USB connection, refer to the Installation Manual.
- When the device for Android Auto is connected to this unit, the device is also connected via Bluetooth at the same time. If five devices are already paired, the message confirming whether to delete the registered device is displayed. If you want to delete the device, touch [Agree]. If you want to delete other device, touch [BT Settings] and delete the devices manually (page 25).
- If Android Auto is turned on during a call on a cellular phone other than the Android Auto compatible device, the Bluetooth connection will switch to the Android Auto compatible device after the call.

Adjusting the volume

You can adjust the guidance volume separately from the main sound volume when Android Auto is used.

1 While Android Auto is activated, touch VOL (+/-).

The volume menu will be displayed on the screen.

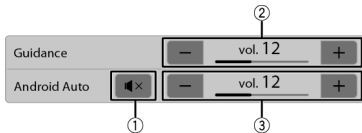

①	Touch to mute. Touch again to cancel mute.
②	Touch [+]/[-] to adjust the guidance volume.
③	Displays the main sound volume. To adjust the main sound volume, touch VOL (+/-) on the unit or touch [+]/[-].

NOTE



The volume menu is displayed for four seconds. If the menu disappears, touch **VOL (+/-)** again. The menu reappears.

Setting the auto-launch function

If this function is set to on, the Android Auto screen is displayed automatically when an Android Auto compatible device is connected to this unit.

NOTE

The Android Auto screen is displayed automatically only when an Android Auto compatible device is correctly connected to this product.

- 1 Touch  then swipe left on the screen.
- 2 Touch  then .
- 3 Touch [Android Auto Auto-launch] to switch [On] or [Off].

Sports

Check team information such as the game scores and game information of your favorite teams registered on CarAVAssist.

Using sports

The unit displays three days of sports information, for the previous, current, and next day.

Important

- To use the sports function, you need to connect this unit to the Internet via a Wi-Fi network.
- To use the sports function, you need to register a team in CarAVAssist and import it to this unit (page 42) in advance.
- To use the sports function, you need to accept the Internet Communication Service the Terms of Use and Privacy Policy (page 110).
- Before connecting this unit to the Internet, make sure that the GPS antenna is installed properly to obtain correct time and date. For details on GPS antenna installation, refer to the Installation Manual.

Starting procedure

1 Touch  then swipe left on the screen.

2 Touch [Sports].

Sports screen

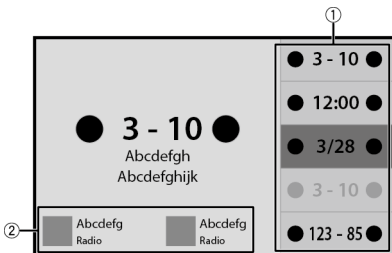

①	Switches the game list between fixed and not fixed.
②	Switches to the displayed radio station.

Weather

Display the current temperature and daily or hourly forecast in your current location. The weather function uses a location service to determine your current location.

Using weather

Important

- To use the weather function, you need to connect this unit to the Internet via a Wi-Fi network.
- To use the weather function, you need to accept the Internet Communication Service the Terms of Use and Privacy Policy (page 110).
- Before connecting this unit to the Internet, make sure that the GPS antenna is installed properly so that your correct location and time can be used for the weather service and location service. For details on GPS antenna installation, refer to the Installation Manual.

Starting procedure

- 1 Touch  then swipe left on the screen.
- 2 Touch [Weather].

Weather screen

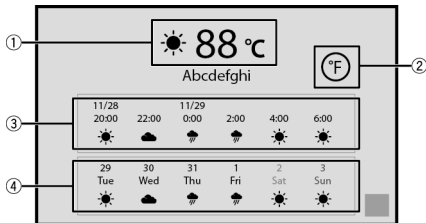

①	Current temperature
②	Switches the temperature unit between Fahrenheit and Celsius.
③	Current hourly forecast
④	Current daily forecast

NOTE

If a data item is unknown or missing, "-" is displayed.

Amazon Alexa

You can talk to Amazon Alexa on the unit. With Alexa Built-in, you can ask to play music, place calls, listen to audiobooks, hear the news, check the weather, control smart home devices and more—all while you keep your hands on the wheel and eyes on the road. For details, visit the Amazon website for your region.

Important

- To use the Amazon Alexa function, you need to connect this unit to the Internet via a Wi-Fi network.
- This function is available in the following languages* and countries:
- * All of the languages supported by Amazon Alexa are currently not available, but will be available soon.

Languages*

- English (US), (CA), (UK), (AU), (IN)
- French
- Spanish (ES)
- German
- Italian
- Japanese

Countries*



- USA
- UK
- Ireland
- Canada
- Germany
- Austria
- India
- Australia
- New Zealand
- France
- Italy
- Spain
- Mexico
- Japan

* Alexa is not available in all languages and countries. Alexa features and functionality may vary by location.

How to use Amazon Alexa

Before using the Amazon Alexa function, it is necessary to authorize the unit.

- 1 Touch  then swipe left on the screen.

- 2 Touch  then .
- 3 Touch [Amazon Alexa setting].
- 4 Touch [Setup].
The introduction screen appears.
- 5 Touch [Get started].
- 6 Use your mobile device to go to the displayed URL or scan the QR code.
- 7 Enter your Amazon account Email address and password.
- 8 Enter the code that is shown in step 6.
A completion message is displayed when the unit is authorized.

TIP

If you scan the QR code in step 6, you can skip this step.

NOTES

- Make sure that you have an Amazon account.
- Amazon Alexa cannot recognize your voice in the following cases:
 - Amazon Alexa authorization is not completed.
 - Data is being updated.
 - The unit is starting.
 - The monitor is showing the rearview camera image.

Starting procedure

TIP

When you receive notifications from Amazon Alexa, the yellow visual indicator is displayed. To check the notifications, ask "Alexa, what are my notifications?"

Touch operation

- 1 Touch  then swipe left on the screen.
- 2 Touch [Alexa].
The visual indicator appears.
- 3 Talk to Amazon Alexa to perform the desired operation.

TIP

You can operate the Amazon Alexa function by touching the  button once Amazon Alexa is activated.

Voice operation

- 1 Talk to Amazon Alexa to perform the desired operation by using “Alexa” as the wake word.

NOTE

Wake words other than “Alexa”, such as “Echo”, “Amazon”, or “Computer”, are not supported.

Entertainment

You can play content through Amazon Music, Kindle books text-to-speech, or Audible by talking to Amazon Alexa.

Important

To use the entertainment function, you need to subscribe to the Amazon service.

Starting procedure

► Touch operation





- 1 Touch  then swipe left on the screen.
- 2 Touch [Alexa].
- 3 Talk to Amazon Alexa to perform the desired AV operation.

► Voice operation

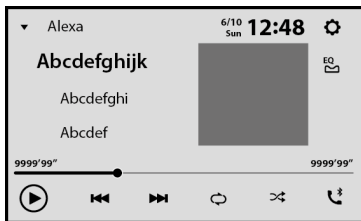
- 1 Talk to Amazon Alexa to perform the desired AV operation by using “Alexa” as the wake word.



Alexa screen 1 (Example: Amazon Music)

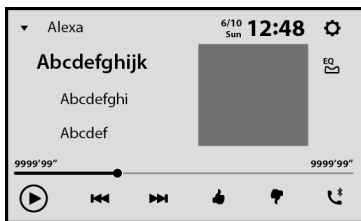

	Switches between playback and pause.
	Skips songs forward or backward.
	Switches the repeat function ON/OFF.
	Switches between random and normal song playback order.

Alexa screen 2 (Example: Amazon Music)



	Gives a Like to the currently playing song.
	Gives a Dislike to the currently playing song.

Phone call control

Alexa allows you to use voice commands to place or answer calls using a mobile device paired to this unit.

Important



- To use this function, turn on the Amazon Alexa function.
- To make a phone call using your contacts, you need to allow Alexa to access the contact information on your mobile device.
- To use this function, you need to install the Amazon Alexa app on your mobile device that is paired with this unit, and sign in to the same Amazon account as the one for this unit.
- To enable this function, you need to fill in all the required information in the Amazon Alexa app installed on your mobile device.

NOTE

Support for the Alexa Calling service will be available soon.



Before using phone call control

Before using this function, connect your mobile device to this unit via Bluetooth.

- 1 Touch  then swipe left on the screen.
- 2 Touch  then .
- 3 Touch [Amazon Alexa setting] then [Main Menu].
- 4 Touch [Settings] then [Contact list].
- 5 Select the desired mobile device.

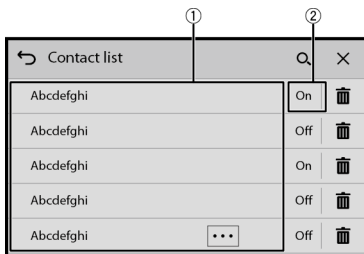
Contact list screen



①	Device name list
②	Contact list upload status Select [On], then select [Yes] on the permission screen to upload the contacts from the selected mobile device.
	Searches for available mobile devices.
	Deletes the mobile device.

Starting procedure



► Touch operation

- 1 Touch  then swipe left on the screen.
- 2 Touch [Alexa].
- 3 Talk to Amazon Alexa to perform the desired hands-free phone operation.

► Voice operation

- 1 Talk to Amazon Alexa to perform the desired hands-free phone operation by using "Alexa" as the wake word.
For example, say "Alexa, call home" or "Alexa, answer the call".

Amazon Alexa settings

- 1 Touch  then swipe left on the screen.
- 2 Touch  then .
- 3 Touch [Amazon Alexa setting].

[Setup]

[Setup] Set up the Amazon Alexa function to be activated.

[Main Menu]

[Settings]	Settings for Amazon Alexa for this unit (page 80).
[Things to try]	Trial and examples of uses for Amazon Alexa.
[Help & Feedback]	Displays the URL of Amazon Alexa help and feedback.
[Sign out]	Signs out of your Amazon account and disables the Amazon Alexa function.

[Settings]

[Contact list]	Displays the list of mobile devices that are connected to Amazon Alexa (page 78). NOTE The device search list screen is displayed when no mobile device is paired via Bluetooth.
[Hands-free listening]	Switches whether or not to use the wake word (“Alexa”).
[Notifications]	Switches whether or not notifications of received messages are displayed.
[Share location]	Switches whether or not Amazon Alexa has access to location information. TIP When you share your location, Amazon Alexa provides more accurate service and information, such as weather, traffic information, etc. NOTE You need to enable the location services for the Amazon Alexa app on your mobile device in order to search for nearby places.
[Start of request sound]	Switches whether or not Amazon Alexa plays a sound when you begin your request.
[End of request sound]	Switches whether or not Amazon Alexa plays a sound when you finish your request.
[Language]	Select the language for using Amazon Alexa.

Controlling the unit by Amazon Alexa

You can enable Alexa Skills and control this unit by using Amazon Alexa voice commands. For details, visit the Alexa Skills Store website for your region.



SiriusXM® Satellite Radio

Only SiriusXM® brings you more of what you love to listen to, all in one place. Get over 140 channels, including commercial-free music plus the best sports, news, talk, comedy, and entertainment. Welcome to the world of satellite radio. A SiriusXM Connect Vehicle Tuner and Subscription are required. For more information, visit the website (www.siriusxm.com).

To take full advantage of all the SiriusXM capabilities, such as TuneMix™, SportsFlash™ and Traffic & Weather Now, please use the SXV300 tuner or one of the newer SiriusXM tuners (sold separately). Other tuners are compatible but may limit the features.

Subscribing to the SiriusXM Satellite Radio service

1 Touch  then swipe left on the screen.

2 Touch [SiriusXM].

You should be able to tune in to Channel 1. If you cannot get Channel 1, ensure that your SiriusXM Connect Vehicle Tuner is installed correctly.

3 Switch to Channel 0 and check the Radio ID.

The SiriusXM Radio ID can be found by tuning in to Channel 0. In addition, the Radio ID is located on the bottom of the SiriusXM Connect Vehicle Tuner and its packaging. You will need this number to activate your subscription.

NOTE

The SiriusXM Radio ID does not include the letters I, O, S, or F.

4 Activate the service either online or by phone.

TIP

In the USA, you can activate online or by calling SiriusXM Listener Care:

- Visit the website
www.siriusxm.com/activatenow
- Call SiriusXM Listener Care at
1-866-635-2349

For Canadian subscriptions, please contact:

- Visit the website
www.xmradio.ca
and click on "ACTIVATE RADIO" at the top right corner of the page, or call (1-877-438-9677).

NOTES

- The SiriusXM satellites will send an activation message to your tuner. When the tuner has received the message, [Subscription Updated Press Enter to Continue] is displayed.
- The activation process usually takes 10 to 15 minutes, but it may take up to an hour. Do not turn off this product while the activation message is displayed.

Listening to SiriusXM

- 1 Touch  then swipe left on the screen.
- 2 Touch [SiriusXM].







Basic operation

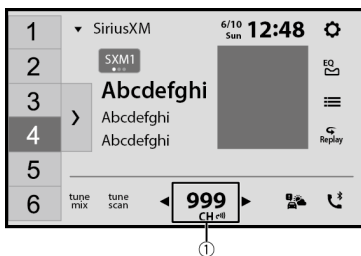







TIPS



- On the Featured Favorites Band, the current broadcast frequency cannot be stored to a key (page 86).
- If fewer than two music channels are stored as presets, you cannot use the TuneMix function.
- [RADIO ID] is displayed when Channel 0 is selected.

Current channel display (Live broadcast mode)









①	Selects a channel directly.
 	 Recalls the preset channel stored to a key from the memory.  Stores the current channel to a key.
	Displays the preset channels. Select an item on the list ([1] to [6]) to switch to the preset channel.
	Selects a band. There are 3 bands and a Featured Favorites. You can store 6 channels per band for a total of 18 presets.

tune mix	<p>Switches TuneMix™ to on or off. You can use TuneMix™ from each of the music channels stored as presets on the current band.</p> <p>NOTES</p> <ul style="list-style-type: none"> • When fewer than two music channels are stored as presets, you cannot use TuneMix™. • Locked channels will not be used by TuneMix™ until the channels are unlocked by entering the parental control passcode.
tune scan	<p>Performs TuneScan™ (page 84).</p>
	<p> Performs channel number up/down.</p>
	<p>Performs fast channel number up/down.</p> <p>NOTE</p> <p>The operation stops if the icon is touched and held for more than 30 seconds. To resume the operation, touch and hold the icon again.</p>
	<p>Switches to the channel broadcasting the traffic and weather information for the selected city (Traffic & Weather Now™). Touch the desired city to access the latest Traffic & Weather report for your favorite market. To cancel Traffic & Weather Now™, touch .</p> <p>TIPS</p> <ul style="list-style-type: none"> • Grayed out: Traffic and weather broadcast for your market is not yet available. • With green dot: Latest report available, but not listened to yet. • White: Latest report available to hear again. • To listen to the information again, touch  on the current channel display. • If you have not selected the city, touch  to select the city. You can also select the city in advance (page 87). • If you have already selected the city, you can listen to the information only by touching . <p>NOTES</p> <ul style="list-style-type: none"> • To use this function, select the city in advance (page 87). • The selected city can be changed in the SiriusXM settings (page 87).
	<p>Switches to Replay™ Mode.</p>

	<p>Selects a channel from the list. Select the category name or the list of all channels then touch the desired channel. To switch the display list, touch .</p> <p>TIPS</p> <ul style="list-style-type: none"> The displayed list switches in the following order. Channel Name—Artist Name—Song Title—Content Info If you touch , you can scan each channel in the selected category. When there is no category, you can select the channel from [Others]. <p>NOTES</p> <ul style="list-style-type: none"> The types of categories available depend on the types of channels available. It may take time to display the channel list depending on the SiriusXM reception condition.
---	---

Replay™ Mode (Time bar display)



	<p>Switches between playback and pause.</p>
	<p>Performs content forward or backward.</p> 
	<p>Performs fast forward or rewind.</p>  <p>NOTE</p> <p>The operation stops if the icon is touched and held for more than 30 seconds. To resume the operation, touch and hold the icon again.</p>
	<p>Switches to live broadcast mode.</p>

TuneScan™



When you activate the TuneScan™ feature, you will hear a few seconds of the songs which have not been listened to from each of the music channels stored as presets on the current band.

NOTES

- When fewer than two music channels are stored as presets, you cannot use TuneScan™.
- TuneScan™ may take a few minutes to become available after the product is turned on or the preset band is changed.

1 Touch  to display the following display.



	Continues playing the current scanning song or channel.
	Skips to the previous/next song during TuneScan™ or to the previous/next channel during category scan.
	Cancels scan play and returns to the previous channel.

SportsFlash™

SportsFlash™ will notify you when a big play happens during a game with one of your favorite sports teams.

Choose to tune in and hear the play unfold like it was live. Continue listening to the game, or you can return to your previous channel.

For details, see [SportsFlash] (page 87) and [SportsFlash List] (page 87) in SiriusXM settings.

SmartFavorites

All preset channels will buffer the content to be used for Replay, TuneStart, TuneScan and TuneMix features.

Using Featured Favorites Band

Featured Favorites are groups of channels that are created by the SiriusXM Programming department allowing you to discover new channels. Featured Favorite channels are dynamic and can change often, allowing you to discover new channels.

For details, see [Featured Favorites] and [Featured Band Update Message] in SiriusXM settings (page 86).

How to access

When there is a Featured Favorite, access it with the band key.

1 Touch the band key.

SXM1—SXM2—SXM3—FF

When there are multiple Featured Favorites, access them from the category list. It is displayed at the bottom of the category list (page 84).

Parental lock

The Parental Control feature allows you to limit access to any SiriusXM channels, including those with mature content. When enabled, the Parental Control feature requires you to enter a passcode to tune to the locked channels.

For details, see [Parental Control] in SiriusXM settings (page 87).

SiriusXM settings

1 Touch then swipe left on the screen.

2 Touch then .



The system setting screen appears.

3 Touch [AV Source Settings].

4 Touch [SiriusXM settings].

The menu items vary depending on whether SiriusXM is selected as the source.

Menu Item	Description
[Tune Start] [On] [Off]	Start songs automatically from the beginning when you tune to one of your preset channels in the current preset band when TuneStart™ is turned on.

Menu Item	Description
[Parental Control]	<p>Enter the current passcode then touch  to set this function (the default passcode is 0000).</p> <ul style="list-style-type: none"> • To edit the passcode, touch [Edit Code] then touch  followed by entering the new passcode. • To lock the channel, touch the appropriate channel.  appears and the channel is locked. <p>TIPS</p> <ul style="list-style-type: none"> • When you touch the locked channel, the channel is unlocked. • When you touch [Clear All], all locked channels are unlocked.
[Featured Favorites] [On] [Off]	<p>Set to [On] to allow you to discover new channels created by the SiriusXM Programming department.</p> <p>NOTE</p> <p>When [Featured Band Update Message] is set to [On] and the Featured Favorite Band is updated, the Featured Band Update message will appear.</p>
[Featured Band Update Message] [On] [Off]	<p>Set to [On] to be notified when the featured seasonal theme is updated.</p> <p>TIP</p> <p>To display [Featured Band Update Message] at all times, [Featured Favorites] needs to be set to [On].</p>
[SportsFlash] [On] [Off]	<p>Set to [On] to activate the SportsFlash™ function.</p> <ul style="list-style-type: none"> • Touch [Play] to listen to the notified channel. • Touch [Ignore] to stay tuned to the current channel. • Touch [Cancel] to cancel notifications regarding the game.
[SportsFlash List]	<p>Select favorite teams for SportsFlash™.</p> <ul style="list-style-type: none"> • Touch [Edit List] then select a league and team to set the favorite. <p>TIPS</p> <ul style="list-style-type: none"> • You can touch an item again to deselect it. • If you want to remove all the teams you have set, touch [Clear All]. <p>Setting of priorities</p> <p>If you set many Favorite Teams, up to 5 Favorite Teams can be received at once. Set the priorities if more than six teams are set as Favorite Teams.</p> <ol style="list-style-type: none"> 1 Touch [Prioritize] on the team selection screen. 2 Select the five high priority teams from the selected favorite teams.
[City List]	<p>Select the city for the latest traffic and weather report in Traffic & Weather Now™.</p>

Menu Item	Description
[SiriusXM Reset]	<p>Set to restore to the default SiriusXM settings by touching [Restore].</p> <p> CAUTION Do not turn off the engine while restoring the settings.</p> <p>NOTE The source is turned off before the process starts.</p>

HDMI

⚠ CAUTION

For safety reasons, video images cannot be viewed while your vehicle is in motion. To view video images, stop in a safe place and apply the parking brake.

NOTE

A micro HDMI® cable (sold separately) is required for connection. For details, refer to the Installation Manual.

Starting procedure

- 1 Connect an HDMI device to this unit via a micro HDMI cable (sold separately) then turn on the device.
- 2 Touch  then swipe left on the screen.
- 3 Touch [HDMI].
The HDMI source screen appears.

Basic operation

HDMI source screen

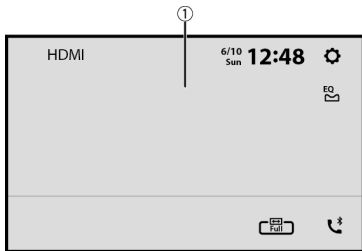

①

Hides the touch panel keys.

To display the keys again, touch anywhere on the screen.

TIP

You can set the screen size for the video image (page 120).

AUX

You can display the video image output by the device connected to video input.





⚠ CAUTION

For safety reasons, video images cannot be viewed while your vehicle is in motion. To view video images, stop in a safe place and apply the parking brake.

NOTE

A Mini-jack AV cable (sold separately) is required for connection. For details, refer to the Installation Manual.

Starting procedure

- 1 Touch  then swipe left on the screen.
- 2 Touch  then .
- 3 Touch [Input/Output settings].
- 4 Confirm that [AUX Input] is turned on.
- 5 Touch  then swipe left on the screen.
- 6 Touch [AUX].
The AUX screen appears.

Basic operation

AUX screen

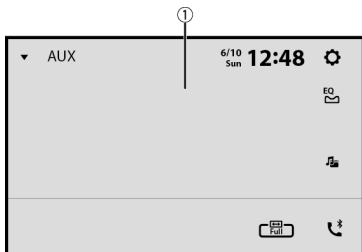

①	Hides the touch panel keys. To display the keys again, touch anywhere on the screen. TIP You can set the screen size for the video image (page 120).
	Switches between the video input and audio input.

External component

Camera view





You can display the video image output using the device connected to the back camera input or 2nd camera input.* For details, refer to the Installation Manual.

* The 2nd camera input is available only for DMH-WT8600NEX/DMH-WT7600NEX/DMH-WC6600NEX/DMH-W4660NEX.

Starting procedure

- 1 Touch  then swipe left on the screen.
- 2 Touch [Camera View].
Video footage is displayed on the screen.

Displaying 2nd camera view

- 1 Touch  then swipe left on the screen.
- 2 Touch  then .
- 3 Touch [Input/Output settings].
- 4 Touch [AV Input].
- 5 Touch [2nd Camera].
- 6 Touch  then swipe left on the screen.
- 7 Touch [Camera View].
- 8 Touch  to switch the camera view.
The 2nd camera video footage is displayed on the screen.

iDatalink

Using iDatalink

You can access the satellite radio source provided for the vehicle. The vehicle information and many OEM systems such as steering wheel controls, warning chimes, driver safety systems, and etc. can be displayed on this product by connecting the optional iDatalink adaptor. It is also possible to add visual screens such as gauges, vehicle information, climate control, and parking assist. However, an extra interface module is required to access these features.

NOTE

Since the type of module varies depending on the vehicle model, search for your vehicle via the following URL to determine which features are available for each module. Remember to select the correct radio model for accurate results.

<http://maestro.idatalink.com/support>



Important

- For details about vehicle models that are compatible with the iDatalink adaptor, refer to the information on our website.
- After installing the iDatalink adaptor, be sure to check that it operates properly.
- Functions and displays vary depending on the vehicle model. For details on the functions available for each model, refer to the information on our website.
- For troubleshooting information about iDatalink functions, visit the following website:
<http://maestro.idatalink.com/support>

Limitations

- The data is transmitted to this product from your vehicle system via the connected iDatalink adaptor. Therefore, the actual data contents displayed on your product may differ from the contents on the screen described in this manual.
- When information on your vehicle or on the devices in your vehicle is sent from the iDatalink Maestro module, a screen notifying you of such information may pop up.

Activating iDatalink Maestro

Before using and/or connecting the iDatalink Maestro adaptor, you will need to first flash the Maestro RR module with the appropriate vehicle and head unit firmware.

- 1 Find the device number (12 alphanumeric characters) on the label on the packaging of this product or on the product itself.**
- 2 Access the following website and follow the on-screen instructions to configure the desired firmware.**

<http://maestro.idatalink.com/>

NOTE





When the serial number input is required, input the device number of this product.

- 3** Install the vehicle/head unit-specific firmware on your iDatalink Maestro module.
- 4** Connect this product to the iDatalink Maestro and install this product to the vehicle.
The iDatalink function will be active.

NOTES

- For details on installing the firmware, refer to iDatalink Maestro website.
- For details on connecting this product to iDatalink Maestro, refer to the Installation Manual.
- You can also check the device number on the [Firmware Information] screen of this product (page 107).

Starting procedure

- 1** Connect the iDatalink Maestro adaptor to this product.
For details, refer to the Installation manual.
- 2** Touch .
- 3** Touch  then .
- 4** Touch [Input/Output settings].
- 5** Touch [AV Input].
- 6** Confirm that [iDataLink] is selected.
- 7** Touch  then swipe left on the screen.
- 8** Touch [Car Sources] or [Car Features].
The menu screen you touched appears.

NOTE

The iDataLink function is available only when the input signal is received by the iDatalink Maestro adaptor.







Using the functions on [Car Sources]

[Car Sources] is operated almost the same way as the built-in AV sources on this product is operated. For details on the operation, refer to the following relevant pages.

- Operating via USB/iPhone (page 53) (page 60)
- Operating via SiriusXM (page 81)
- Operating via Bluetooth audio (page 31)
- Operating via Hands-free phone (page 26)

Using the functions on [Car Features]

You can check and use the following screens after selecting [Car Features] in the starting procedure. Touch one of the icons on the left side of the screen to change a feature.

	Displays the Gauge screen.
	Displays the Vehicle Information screen.
	Displays the Climate screen.
	Displays the Parking Assist screen.
	Displays the Speed Radar Detector screen.
	Displays rear monitor mirroring when the rear monitor is connected via iDataLink.

Gauges screen

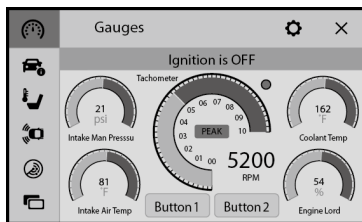

Vehicle Information screen

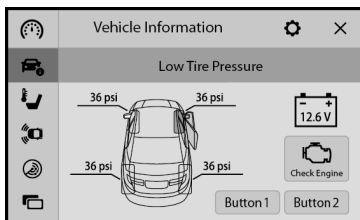

Climate screen

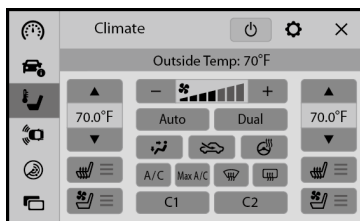

Parking Assist screen

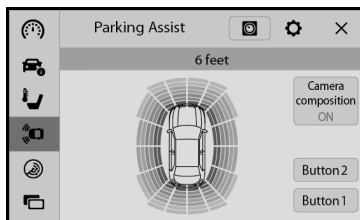

Speed Radar Detector screen

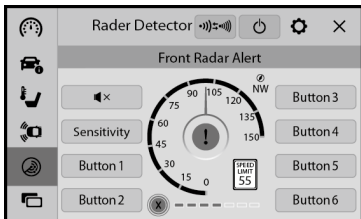

Displaying obstacle detection information



⚠ CAUTION

This function is intended solely to assist the driver's vision. It does not detect all dangers and obstacles and is not a substitute for your attentiveness, judgement, and care while parking your vehicle.

NOTE

This function is only available for vehicles equipped with a parking sensor system.

iDatalink settings

- 1 Touch  then swipe left on the screen.
- 2 Touch  then .
- 3 Touch [OEM Settings] or [OEM Volume Settings].
The setting screen for iDatalink appears.

Menu Item	Description
[OEM Settings]	Setting for iDatalink function when the iDatalink adaptor is connected to the unit.
[OEM Volume Settings]	Setting for iDatalink function volume when the iDatalink adaptor is connected to the unit.

Metra Axxess

Using Metra

Access the vehicle information and many of the OEM systems such as climate control, driver safety systems, etc. and display them on this product by replacing the Metra parts kit with interface conversion.

NOTE

Since the type of module varies depending on the vehicle model, search for your vehicle via the following URL to determine which features are available for each module.
<http://metraonline.com/>



Important

- For details about vehicle models that are compatible with the Metra interface conversion unit, refer to the information on Metra website.
- After installing the Metra interface conversion unit, be sure to check that it operates properly.
- Functions and displays vary depending on the vehicle model. For details on the functions available for each model, refer to the information on our website.
- For troubleshooting information about the Metra interface conversion functions, visit the following website. <http://www.metraonline.com/contact-us>

Limitations



- The data is transmitted to this product from your vehicle system via the connected Metra interface conversion unit. Therefore, the actual data contents displayed on your product may differ from the contents on the screen described in this manual.

Starting procedure

- 1 Connect the Metra interface conversion unit to this product.**
For details, refer to the Installation manual.
- 2 Touch  then swipe left on the screen.**
- 3 Touch [Car Features].**
The menu screen appears.

Using the functions on [Car Features]

You can check and use the following screens after selecting [Car Features] in the starting procedure. Touch one of the icons on the left side of the screen to change a feature.

	Displays the Vehicle Information screen.
	Displays the Climate screen.
	Displays the Radio ID screen.

Vehicle information screen

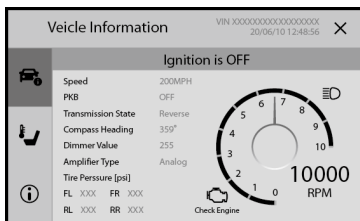

Climate screen

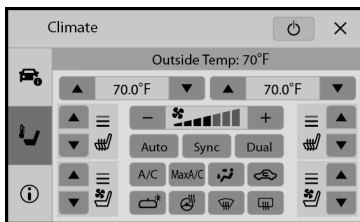



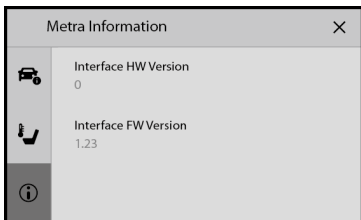



Radio ID screen



Settings

You can adjust various settings in the main menu.

Displaying the setting screen

- 1 Touch  then swipe left on the screen.
- 2 Touch .
- 3 Touch one of the following categories, then select the options.
 -  System settings (page 101)
 -  Theme settings (page 110)
 -  Audio settings (page 112)
 -  Video settings (page 116)
 -  Communication settings (page 117)

System settings

The menu items vary according to the source.

[AV Source Settings]

Menu Item	Description
[Suggestions] [On] [Off]	Select [On] to activate the suggested radio stations or area radio stations list function.
[Radio settings]	(page 51)
[SiriusXM settings]	(page 86)
[Bluetooth Audio] [On] [Off]	Setting Bluetooth audio source activation.

[Beep Tone]

Menu Item	Description
[Beep Tone] [On] [Off]	Select [Off] to disable the beep sound when the button or the screen is touched.

[Input/Output settings]

Menu Item	Description
[USB MTP] [Off] [On]	Select [On] to use the USB MTP (Media Transfer Protocol) connection. Select [Off] to use Android Auto.
[AV Input] [2nd Camera]* [iDataLink] [Off]	Select AV input source.
[AUX Input] [On] [Off]	Set to [On] for AUX source (page 90).

* DMH-WT8600NEX, DMH-WT7600NEX, DMH-WC6600NEX, DMH-W4660NEX

[Camera settings]

A separately sold rear view camera (e.g. ND-BC8) is required for utilizing the rear view camera function. (For details, consult your dealer.)

►Rear view camera

This product features a function that automatically switches to the full-screen image of the rear view camera installed on your vehicle when the shift lever is in the REVERSE (R) position.

Camera View mode also allows you to check what is behind you while driving.

TIP

The parking assist guidelines can be displayed temporarily on the rear view camera screen by touching the icon at the top left of the screen. The guidelines can be adjusted. For details on how to adjust the guidelines, see [Parking Assist Guide Adjust] (page 104).

►Camera for Camera View mode

Camera View can be displayed at all times. Note that with this setting, the camera image is not resized to fit, and that a portion of what is seen by the camera is not viewable.

To display the camera image, touch [Camera View] on the source/application selection screen (page 46).

NOTES

- To set the rear view camera as the camera for Camera View mode, set [Back Camera Input] to [On] (page 103).
- When using the 2nd camera, set [AV Input] to [2nd Camera] (page 102).*
- When the camera view of both the rear view camera and 2nd camera are available, the key to switch the display appears. Touch this key to switch the display between the rear view image and 2nd camera image.*

* DMH-WT8600NEX, DMH-WT7600NEX, DMH-WC6600NEX, DMH-W4660NEX

CAUTION

Pioneer recommends the use of a camera which outputs mirror reversed images, otherwise the screen image may appear reversed.

- Immediately verify whether the display changes to the rear view camera image when the shift lever is moved to REVERSE (R) from another position.
- When the screen changes to full-screen rear view camera image during normal driving, switch to the opposite setting in [Camera Polarity].
- If you touch  while the camera image is displayed, the displayed image turns off temporarily.

Menu Item	Description
[Back Camera Input] [Off] [On]	Setting rear view camera activation.
[Camera Polarity]	Setting the polarity of the rear view camera.
[Battery]	The polarity of the connected lead is positive.
[Ground]	The polarity of the connected lead is negative.
	NOTE This function is available when [Back Camera Input] is set to [On].

Menu Item	Description
[Parking Assist Guide Adjust]	<p>Adjusting the guidelines by dragging or touching ▲/▼/◀/▶ on the screen. Touch [Default] to reset the settings.</p> <p>⚠ CAUTION</p> <ul style="list-style-type: none"> When adjusting the guidelines, park the vehicle in a safe place and apply the parking brake; this setting is available only when the vehicle is parked with the parking brake applied. Turn the vehicle off before getting out to place the markings. The range projected by the rear view camera is limited. Also, the vehicle width and distance guidelines displayed on the rear view camera image may differ from the actual vehicle width and distance. (The guidelines are straight lines.) The image quality may deteriorate depending on the usage environment, such as at night or in dark surroundings. <p>NOTES</p> <ul style="list-style-type: none"> Use painter's tape or similar tape to place markings as shown below before setting up the guidelines. Adjust the guidelines so that they overlay the tape markings as closely as possible.

[Demo Mode]

Menu Item	Description
[Demo Mode] [On] [Off]	Setting the demo mode.

[System Language]

Menu Item	Description
[System Language]	<p>Select the system language.</p> <p>NOTES</p> <ul style="list-style-type: none"> • If the embedded language and the selected language setting are not the same, the text information may not display properly. • Some characters may not be displayed properly.

[Restore Settings]

Menu Item	Description
[All Settings]	<p>Touch [Restore] to restore the settings to the default settings.</p> <p>⚠ CAUTION</p> <p>Do not turn off the engine while restoring the settings.</p> <p>NOTES</p> <ul style="list-style-type: none"> • This setting is available only when you stop your vehicle in a safe place and apply the parking brake. • The source is turned off and the Bluetooth connection is disconnected before the process starts. • Before starting the restore process, disconnect any device that is connected to the USB port. Otherwise, some settings may not be restored correctly.

[Clock Settings]

Menu Item	Description
[Clock Settings]	<p>Setting or adjusting the following time and clock display.</p> <ul style="list-style-type: none"> • Date display format: day-month-year, month-day-year, or year-month-day • Time display format: [12hour] or [24hour] • UTC (Universal Time Coordinated) time zone difference: [UTC-12h] to [UTC+14h] • Day-light saving time: [On] or [Off]

[Dimmer Settings]

NOTE

This setting is available only when you stop your vehicle in a safe place and apply the parking brake.

Menu Item	Description
[Dimmer Trigger]	Setting the dimmer brightness.
[Auto]	Switches the dimmer to on or off automatically according to your vehicle's headlight turning on or off.
[Manual]	Switches the dimmer to on or off manually.
[Time]	Switches the dimmer to on or off at the time you adjusted.
[Day/Night]	Setting the dimmer duration by day or night. You can use this function when [Dimmer Trigger] is set to [Manual].
[Day]	Turns the dimmer function to off.
[Night]	Turns the dimmer function to on.
[Dimmer Duration]	Adjust the time that the dimmer is turned on or off by dragging the cursors or touching ◀ or ▶. You can use this function when [Dimmer Trigger] is set to [Time]. TIPS <ul style="list-style-type: none">• Each touch of ◀ or ▶ moves the cursor backward or forward in the 15 minute width.• When the cursors are placed on the same point, the dimmer available time is 0 hours.• When the cursor for off time setting is placed on the left end and the cursor for on time setting is placed on the right end, the dimmer available time is 0 hours.• When the cursor for on time setting is placed on the left end and the cursor for off time setting is placed on the right end, the dimmer available time is 24 hours. NOTE <p>The time display of the dimmer duration adjusting bar depends on the clock display setting (page 120).</p>

[Picture Adjustment]

You can adjust the picture for each source, rear view camera.

CAUTION

For safety reasons, you cannot use some of these functions while your vehicle is in motion. To enable these functions, you must stop in a safe place and apply the parking brake.

To adjust following menu, touch ◀, ▶, ▲, ▼ to adjust.

Menu Item	Description
[Brightness] [-24] to [+24]	Adjust the black intensity.
[Contrast] [-24] to [+24]	Adjust the contrast.
[Color]* [-24] to [+24]	Adjust the color saturation.
[Hue]* [-24] to [+24]	Adjust the tone of color (which color is emphasized, red, or green).
[Dimmer] [+1] to [+48]	Adjust the brightness of the display.
[Temperature] [-3] to [+3]	Adjust the color temperature, resulting in a better white balance.

* With some pictures, you cannot adjust [Hue] and [Color].

NOTES

- The adjustments of [Brightness], [Contrast], and [Dimmer] are stored separately when your vehicle's headlights are off (daytime) and on (nighttime).
- [Brightness] and [Contrast] are switched automatically depending on the setting of [Dimmer Settings].
- [Dimmer] can be changed the setting or the time to switch it to on or off (page 106).
- The picture adjustment may not be available with some rear view cameras.
- The setting contents can be memorized separately.

[System Information]

Menu Item	Description
[Firmware Information]	Displaying the firmware version.

Menu Item	Description
[Firmware Update]	<p>Update to the latest version of the firmware by using a USB storage device or wireless connection. To update the firmware via wireless connection, CarAVAssist is required. For details on performing the wireless update, refer to Updating the firmware wirelessly (page 42).</p> <p>⚠ CAUTION</p> <ul style="list-style-type: none">• The USB storage device for updating must contain only the correct update file.• Never turn this product off, disconnect the USB storage device while the firmware is being updated.• You can only update the firmware when the vehicle is stopped and the parking brake is engaged. <ol style="list-style-type: none">1 Download the firmware update files into your computer.2 Connect a blank (formatted) USB storage device to your computer then locate the correct update file and copy it onto the USB storage device.3 Connect the USB storage device to this product (page 53).4 Turn the source off (page 46).5 Display the [System] setting screen (page 101).6 Touch [System Information].7 Touch [Firmware Update].8 Touch [USB].9 Touch [Continue]. <p>Follow the on-screen instructions to finish updating the firmware.</p> <p>NOTES</p> <ul style="list-style-type: none">• This product will reset automatically after the firmware update is completed if the update is successful.• If an error message appears on the screen, touch the display and perform the above steps again.

Menu Item	Description
[3D Calibration Status]	<p>Check the sensor learning status, such as the degree of learning. You can also check the current sensor values and the total number of speed pulses.</p> <p>To delete the learned results stored in the sensor, follow the below instructions.</p> <ol style="list-style-type: none"> 1 Touch [Distance] or [Speed Pulse], and then touch [Yes]. 2 Touch [Learning status] and then touch [Reset All]. <p>TIP</p> <p>Touch [Reset All] to reset the sensor after changing the installation position or angle.</p> <p>NOTE</p> <p>If you touch [Reset Distance], all learned results stored in [Distance] are cleared.</p>
[Connection Status]	<p>Check that the leads are properly connected between this product and vehicle.</p>
[GPS Antenna]	<p>Displays the connection status of the GPS antenna ([OK] or [NOK]) and the reception sensitivity.</p> <p>NOTE</p> <p>If reception is poor, change the installation position of the GPS antenna.</p>
[Positioning Status]	<p>Displays the positioning status (3D positioning, 2D positioning, or no positioning), the number of satellites used for positioning (orange), and the number of satellites that have received signals (yellow). If signals from more than three satellites are received, the current location can be measured.</p>
[Installation]	<p>Indicates whether the installation position of this product is correct or not. If installed correctly, [OK] appears. When this product is installed at an extreme angle exceeding the limitation of the installing angle, [NOK(Inst. Angle)] is displayed. If the installation of this product is continually changed and it is not firmly fixed into place, [NOK(Vibration)] is displayed.</p>
[Speed Pulse]	<p>The speed pulse value detected by this product is shown.</p>
[Back Signal]	<p>When the shift lever is shifted to "R" (reverse position), the signal switches to [High] or [Low]. The signal displayed varies depending on the vehicle.</p>
[License]	<p>Displays the open source license for this unit.</p>

[OEM Settings]

Menu Item	Description
[OEM Settings]	(page 97).

[OEM Volume Settings]

Menu Item	Description
[OEM Volume Settings]	(page 97).

[Amazon Alexa setting]









Setting the Amazon Alexa (page 79).

[Terms of Use / Privacy]

Menu Item	Description
[Terms of Use / Privacy]	<p>Select to accept or withdraw from the Internet Communication Service the Terms of Use and Privacy Policy.</p> <p>NOTES</p> <ul style="list-style-type: none"> • The following functions are not activated unless you agree to the Internet Communication Service the Terms of Use and Privacy Policy: <ul style="list-style-type: none"> – Sports – Browser – Weather – Amazon Alexa • If you do not agree to the Internet Communication Service the Terms of Use and Privacy Policy, the Wi-Fi connection cannot be used to acquire the radio stations list data for the suggested radio stations or area radio stations list function.

Theme settings

The menu items vary according to the source.

Menu Item	Description
[Background]	<p>Select the wall paper from the preset items in this product or original pictures via the external device. The wall paper can be set from selections for the home menu screen and AV operation screen.</p> <p>TIP The colors of the center image and the second image from the right (for the AV operation screen) change randomly, or they change to match the color used for the artwork image.</p> <p>NOTE The [Background] settings are saved for each cellular phone connected via Bluetooth. The settings change depending on the cellular phone that is connected to this unit. If two cellular phones are connected to this unit at the same time, the settings of the first phone are applied.</p>
Preset Display	Select the desired preset background display.
 (custom)*1	Displays the background display image imported from the USB storage device.
 (off)	Hides the background display.
[Illumination]*2	Select an illumination color from the color list or create a defined color.
Colored Keys	Select the desired preset color.
 (custom)	<p>Displays the screen to customize the illumination color. To customize the defined color, touch  then touch  or  to adjust the brightness and the level of red, green and blue to create favorite color. To store the customized color in the memory, touch and hold [Memo], and the customized color will be available at the next illumination setting by touching .</p> <p>TIP You can also adjust the color tone by dragging the color bar.</p>
 (rainbow)	Shifts gradually between the preset colors in sequence.
[Theme]*2	Select the theme color.
[Clock]	Select the style of the clock from the preset image for the [Home] or [AV] screen.
Preset Images	Select the desired preset style for the clock.
 (off)	Hides the clock display on the [AV] screen.

Menu Item	Description
[Home Custom Setting]	Customize the home menu screen of the following items. <ul style="list-style-type: none"> • Switch the favorite source/application area • Customize the displayed favorite source/application and widget • Rearrange the displayed favorite source/application and widget • Adjust the size of the displayed widget

*1 Refer to Still image source (page 58).







*2 You can preview the home menu screen or the AV operation screen by touching [Home] or [AV] respectively.



Audio settings

The menu items vary according to the source. Some of the menu items become unavailable when the volume is set to mute.

Menu Item	Description
[Fader/Balance]	Touch or to adjust the front/rear speaker balance. Set [Front] and [Rear] to [0] when using a dual speaker system. Touch or to adjust the left/right speaker balance. <p>TIP You can also set the value by dragging the point on the displayed table.</p> <p>NOTE This function is available when [Standard Mode] is selected as the speaker mode and [Rear] is selected in [Rear Speaker Output].</p>
[Loudness] [Off] [Low] [Mid] [High]	Compensates for deficiencies in the low-frequency and high-frequency ranges at low volume.

Menu Item	Description
[Source Level Adjuster] [-4] to [+4]	Adjust the volume level of each source to prevent radical changes in volume when switching between sources other than FM. Touch  or  to adjust the source volume after comparing the FM tuner volume level with the level of the source. TIP If you directly touch the area where the cursor can be moved, the SLA (source level adjustment) setting will be changed to the value of the touched point. NOTES <ul style="list-style-type: none"> • Settings are based on the FM tuner volume level, which remains unchanged. • This function is not available when the FM tuner is selected as the AV source.
[Master Sound Reviver] [Off] [Mode1] [Mode2]	Enhances and complements compressed audio and restores it to High-Resolution Audio quality. [Mode1]: Suitable for compressed audio at bitrates higher than 256 kbps. [Mode2]: Suitable for compressed audio at bitrates lower than 256 kbps.
[Speaker Level] Listening Position*1*2 [Off] [Front Left] [Front Right] [Front] [All] Standard Mode*3 [Front Left] [Front Right] [Rear Left] [Rear Right] [Subwoofer] Network Mode*3 [High Left] [High Right] [Mid Left] [Mid Right] [Subwoofer] Speaker output level [-24] to [10]	Adjust the speaker output level of the listening position. 1 Touch  or  to select the listening position then select the output speaker. 2 Touch  or  to adjust the selected speaker output level. NOTE This function is available when [Subwoofer] is set to [On].
[Listening Position]*1 [Off] [Front Left] [Front Right] [Front] [All]	Select a listening position that you want to make as the center of sound effects.

Menu Item	Description
[Balance]	Touch ◀ or ▶ to adjust the left/right balance. NOTE This function is available when [Network Mode] is selected as the speaker mode, or when [Standard Mode] is selected as the speaker mode and [Subwoofer] is selected in [Rear Speaker Output].
[Time Alignment] [On] [Off] Listening Position*1*2 [Off] [Front Left] [Front Right] [Front] [All] Standard Mode*3*4 [Front Left] [Front Right] [Rear Left] [Rear Right] [Subwoofer] Network Mode*3*4 [High Left] [High Right] [Mid Left] [Mid Right] [Subwoofer] Distance [0] to [210]	Select or customize the time alignment settings to reflect the distance between the listener's position and each speaker. You need to measure the distance between the head of the listener and each speaker unit. 1 Touch ◀ or ▶ to select the listening position then select the alignment speaker. 2 Touch ◀ or ▶ to input the distance between the selected speaker and listening position. TIP If you touch [TA On], the time alignment is turned off mandatorily. NOTE This function is available only when the listening position setting is set to [Front Left] or [Front Right].
[Graphic EQ] [Super Bass (S.Bass)] [Powerful] [Natural] [Vocal] [Flat] [Dynamic] [Vivid] [Custom1] [Custom2]	Select or customize the equalizer curve. Select a curve that you want to use as the basis of customizing then touch the frequency that you want to adjust. TIPS <ul style="list-style-type: none"> • If you make adjustments when a curve [Super Bass (S.Bass)], [Powerful], [Natural], [Vocal], [Flat], [Dynamic] or [Vivid] is selected, the equalizer curve settings will be changed to [Custom1] mandatorily. • If you make adjustments when the [Custom2] curve is selected for example, the [Custom2] curve will be updated. • [Custom1] and [Custom2] curves can be created common to all sources. • If you trail a finger across the bars of multiple equalizer bands, the equalizer curve settings will be set to the value of the touched point on each bar.
[Subwoofer] [On] [Off]	Select enable or disable rear subwoofer output from this product.
[Crossover]*5	Select a speaker unit (filter) to adjust the HPF or LPF cutoff frequency and the slope for each speaker unit (page 115).
[Dynamic Bass Enhancer] [Off] [Low] [High]	Increases the bass boost level and gives sound a more dynamic effect.

Menu Item	Description
[Rear Speaker Output] [Rear] [Subwoofer]	Select the rear speaker output. NOTE This function is available when [Standard Mode] is selected as the speaker mode.
[Mute Level]	If an interruption caused by an audio signal occurs while Apple CarPlay or Android Auto is being used, select mute or attenuate the volume of the AV source and iPhone/ smartphone application.
[ATT]	The volume becomes 10 dB lower than the current volume.
[Mute]	The volume becomes 0.
[Off]	The volume does not change.
[Subwoofer Settings]*5	Select the subwoofer phase (page 115).
[Save Settings]	Save to recall the following current sound settings by touching [OK]: slope, subwoofer phase, speaker level, Graphic EQ, HPF/LPF, listening position, crossover, time alignment. TIP When you touch [Cancel], return to the [Audio] setting screen.
[Load Settings] [Initial Settings] [Sound Setting]	Load the sound settings. NOTE [Sound Setting] is available only when you have already saved the sound settings (page 115).

- *1 [All] is not available when [Network Mode] is selected as the speaker mode.
 *2 If you change the listening position setting, the set values for all speakers will change in conjunction with this setting.
 *3 To use this function, the vehicle's acoustics must be measured in advance.
 *4 This function is available only when the listening position setting is set to [Front Left] or [Front Right].
 *5 This function is not available when adjusting the High speaker in [Network Mode].

Adjusting the cutoff frequency value

You can adjust the cutoff frequency value of each speaker.

The following speakers can be adjusted:





[Standard Mode]: Front, Rear, Subwoofer.

[Network Mode]: High, Mid, Subwoofer.

NOTE

[Subwoofer Settings] is available only when [Subwoofer] is [On].

- 1 Touch  then swipe left on the screen.

- 2 Touch  then .
- 3 Touch [Crossover] or [Subwoofer Settings].
- 4 Touch  or  to switch the speaker.
- 5 Drag the graph line to set the cutoff position.
- 6 Drag the lowest point of the graph to set the cutoff slope.
The following items can also be set.

	Switches the subwoofer phase between normal and reverse position. TIP You can also adjust the [High] and [Mid] phase in [Network Mode].
[LPF]/[HPF]	Switches the [LPF]/[HPF] setting to [On] or [Off]. When it is turned off, the high-pass filter or low-pass filter of each speaker can also be turned on by touching the graph lines.



Video settings

The menu items vary according to the source.

[Time Per Photo Slide]

Menu Item	Description
[Time Per Photo Slide] [5sec] [10sec] [15sec] [Manual]	Select the interval of image file slideshows on this product.

[Video Signal Setting]

Menu Item	Description
[AUX] [Auto] [PAL] [NTSC] [PAL-M] [PAL-N] [SECAM]	Select the suitable video signal setting when you connect this product to an AUX equipment.
[Back Camera] [Auto] [PAL] [NTSC] [PAL-M] [PAL-N] [SECAM]	Select the suitable video signal setting when you connect this product to a rear view camera.
[2nd Camera]* [Auto] [PAL] [NTSC] [PAL-M] [PAL-N] [SECAM]	Select the suitable video signal setting when you connect this product to a 2nd camera.

Menu Item	Description
[RSE] [Auto] [PAL] [NTSC] [PAL-M] [PAL-N] [SECAM]	Select the suitable video signal setting when you connect this product to a rear monitor via iDatalink.

* DMH-WT8600NEX, DMH-WT7600NEX, DMH-WC6600NEX, DMH-W4660NEX



Communication settings

[Connection]

Menu Item	Description
[Connection]	<p>Displaying a list of mobile devices that have been connected via Bluetooth or USB. Connect, disconnect, or delete registered mobile device manually. Touch to delete registered device. To connect a registered device manually, perform the following:</p> <ul style="list-style-type: none"> • For an Apple CarPlay or Android Auto connection, touch the name of the device. • For a Bluetooth connection, touch . <p>To disconnect the device, touch in the list.</p> <p>TIP When there is not device in the list, the device search list screen appears then you can connect selected device.</p> <p>NOTE Connect the Bluetooth device manually in the following cases:</p> <ul style="list-style-type: none"> • Two or more Bluetooth devices are registered, and you want to manually select the device to be used. • You want to reconnect a disconnected Bluetooth device. • Connection cannot be established automatically for some reason.

[Bluetooth Settings]

Setting the Bluetooth (page 24) and Hands-free phone (page 29).

[Wi-Fi Settings: Hotspot]

Setting the Wi-Fi connection and network (page 35).

[Wireless Settings: Smartphone]

Setting the infrastructure mode network (page 36).

[Driving Position]

Menu Item	Description
[Driving Position] [Right] [Left]	Setting the driving position. <ul style="list-style-type: none">• Apple CarPlay™ (page 64)• Android Auto™ (page 67)

[Android Auto Auto-launch]

Menu Item	Description
[Android Auto Auto-launch] [On] [Off]	Select [On] to display the Android Auto screen automatically when an Android device is connected to the unit.



Favorite menu

Registering your favorite menu items in shortcuts allows you to quickly jump to the registered menu screen by a simple touch on the [Favorites] screen.

NOTE

Up to 12 menu items can be registered in the favorite menu.



Creating a shortcut

- 1 Touch  then swipe left on the screen.
- 2 Touch .
- 3 Touch the star icon of the menu item for which to create a shortcut.
The star icon for the selected menu is filled in.



TIP

To cancel the registration, touch the star icon in the menu column again.

Selecting a shortcut

- 1 Touch  then swipe left on the screen.
- 2 Touch .
- 3 Touch the desired menu item.

Removing a shortcut

- 1 Touch  then swipe left on the screen.
- 2 Touch .
- 3 Touch and hold the menu item that you want to remove.
The selected menu item is removed from the [Favorites] screen.

Other functions

Setting the clock display

You can set the time format, time zone, daylight saving, and the date format. However, the time and date are automatically adjusted by the GPS antenna and cannot be adjusted by the user.

- 1 Touch the current time on the screen.
- 2 Set the following items in the settings.
 - The date display format:
day-month-year, month-day-year, or year-month-day
 - The time display format:
[12hour] or [24hour]
 - The UTC (Universal Time Coordinated) time zone difference:
[UTC-12h] to [UTC+14h]
 - Day-light saving time:
[On] or [Off]
 You can also configure these items in [Clock Settings] (page 105).

Changing the wide screen mode

You can set the screen mode for AV screen and image files.

- 1 Touch the screen display mode key.

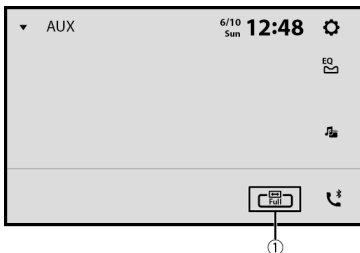

①

Screen display mode key

2 Touch the desired mode.

[Full]	Displays images across the entire screen. NOTE Some images may not be displayed across the entire screen.
[Zoom]	Displays the images enlarging them vertically.
[Normal]	Displays images without changing the ratio.
[Trimming]	An image is displayed across the entire screen with the horizontal-to-vertical ratio left as is. If the screen ratio differs from the image, the image may be displayed partly cut off either at the top/bottom or sides. NOTE [Trimming] is for image files only.

TIPS

- Different settings can be stored for each video source.
- When a video is viewed in wide screen mode that does not match its original aspect ratio, it may appear different.
- The video image will appear coarser when viewed in [Zoom] mode.

NOTES

- Image files can be set to either [Normal] or [Trimming] in wide screen mode.
- Depending on the software version of this unit, this function may vary.

Restoring this product to the default settings

You can restore settings or recorded content to the default settings from [Restore Settings] in  (page 105).

Appendix

Troubleshooting

If you have problems operating this product, refer to this section. The most common problems are listed below, along with likely causes and solutions. If a solution to your problem cannot be found here, contact your dealer or the nearest authorized Pioneer service facility.

Common problems

A black screen is displayed, and operation is not possible using the touch panel keys.

- [Power OFF] mode is on.
 - Touch any button on this product to release the mode.

Bluetooth operation does not work.

- The power failed for the Bluetooth module of this product.
 - Turn the ignition switch to OFF and then to ON.
If the error message is still displayed after performing the above action, please contact your dealer or an authorized Pioneer Service Station.

Problems with the AV screen

The screen is covered by a caution message and the video cannot be shown.

- The parking brake lead is not connected or the parking brake is not applied.
 - Connect the parking brake lead correctly, and apply the parking brake.
- The speed sensor detects that the vehicle is moving.

- Park your vehicle in a safe place and apply the parking brake.

No video output from the connected equipment.

- The [AV Input] or [AUX Input] setting is incorrect.
 - Correct the settings.

The audio or video skips.

- This product is not firmly secured.
 - Secure this product firmly.

No sounds are produced. The volume level will not rise.

- Cables are not connected correctly.
 - Connect the cables correctly.

The icon  is displayed, and operation is impossible.

- The operation is not compatible with the video configuration.
 - The operation is not possible.

Random playback in Music Browse mode is released in the USB storage device.

- Random playback in Music Browse mode is canceled after the ignition switch is turned off (ACC OFF).
 - Switch to Music Browse mode again and turn on random playback.

The picture is stretched, with an incorrect aspect ratio.

- The aspect setting is incorrect for the display.
 - Select the appropriate setting for that image.

iPhone cannot be operated.

- The iPhone is frozen.
 - Reconnect the iPhone with the USB interface cable for iPhone.

- Update the iPhone software version.
- An error has occurred.
 - Reconnect the iPhone with the USB interface cable for iPhone.
 - Park your vehicle in a safe place, and then turn off the ignition switch (ACC OFF). Subsequently, turn the ignition switch to on (ACC ON) again.
 - Update the iPhone software version.
 - Reconnect the iPhone via the Wi-Fi connection.
- Cables are not connected correctly.
 - Connect the cables correctly.

Sound from the iPhone cannot be heard.

- The audio output direction may switch automatically when the Bluetooth and USB connections are used at the same time.
 - Use the iPhone to change the audio output direction.

No back camera image when the vehicle is in reverse.

- The back camera input setting on the receiver is set to Off.
 - Change the back camera setting to On in the settings menu. (Refer to the System Settings section of this manual to adjust.)
- The camera input may be loose or not connected.
 - Check the connection and make sure the male end of the camera is connected to the brown input on the back of the receiver. (Refer to the installation manual.)
- The reverse lead on the receiver may not be connected to the proper wire at the reverse lamp.
 - Check the connection and make sure that the violet/white lead of the receiver is connected to the lead whose voltage changes when the shift lever is put in reverse. (Refer to the installation manual.)

Black screen displayed when the vehicle is in reverse, with no camera installed.

- Back camera input is set to On.
 - Turn the setting to Off in the settings menu. (Refer to the System Settings section of this manual to adjust.)

Back image displayed when vehicle is not in reverse.

- The camera polarity is not set properly in the Camera settings menu.
 - Review System Settings section of this manual for steps to switch the camera polarity. Park in a safe place, then while keeping your foot firmly on the brake, put the vehicle in reverse, access the System Settings menu, and change the camera polarity setting. Put vehicle back in park. (Refer to the System Settings section of this manual to adjust.)

Problems with the phone screen

Dialing is impossible because the touch panel keys for dialing are inactive.

- Your phone is out of range for service.
 - Retry after re-entering the range for service.
- The connection between the cellular phone and this product cannot be established.
 - Perform the connection process.
- Of the two cellular phones connected to this product at the same time, if the first phone is dialing, ringing or a call is in progress, dialing cannot be performed on the second phone.
 - When the operation on the first of the two cellular phones is completed, use the switch devices key to switch to the second phone and then dial.

Problems with Application screen

A black screen is displayed.

- While operating an application, the application was ended on the smartphone side.
 - Touch  to display the home menu screen.
- The smartphone OS may be awaiting screen operation.
 - Stop the vehicle in a safe place and check the screen on the smartphone.

The screen is displayed, but operation does not work at all.

- An error has occurred.
 - Park your vehicle in a safe place, and then turn off the ignition switch (ACC OFF). Subsequently, turn the ignition switch to on (ACC ON) again.
 - When an Android device is connected, disconnect the Bluetooth connection from this product and then reconnect it.

The smartphone was not charged.

- Charging stopped because the temperature of the smartphone rose due to prolonged use of the smartphone during charging.
 - Disconnect the smartphone from the cable, and wait until the smartphone cools down.
- More battery power was consumed than was gained from charging.
 - This problem may be resolved by stopping any unnecessary services on the smartphone.

Error messages

When problems occur with this product, an error message appears on the display. Refer to the table below to identify the

problem, then take the suggested corrective action. If the error persists, record the error message and contact your dealer or your nearest Pioneer service center.

Common

AMP Error

- This product fails to operate or the speaker connection is incorrect; the protective circuit is activated.
 - Check the speaker connection. If the message fails to disappear even after the engine is switched off/on, contact your dealer or an authorized Pioneer Service Station for assistance.

Product overheat. System will be shut down automatically in 1 minute. Restart the product by ACC-Off/On may fix this problem. If this message keep showing up, it is possible that some problem occurred in the product.

- The temperature of the main unit is too high.
 - Turn off the ignition switch (ACC OFF) then wait until the main unit temperature reaches low.

SiriusXM® Satellite Radio

Check Antenna

- The antenna connection is incorrect.
 - Check the antenna connection. If the message fails to disappear even after the engine is switched off/on, contact your dealer or the nearest authorized Pioneer service center for assistance.

Check Tuner

- The SiriusXM Connect Vehicle Tuner connection is incorrect.
 - Check the tuner connection and battery voltage. If the message fails to

disappear even after the engine is switched off/on, contact your dealer or the nearest authorized Pioneer service center for assistance.

No Signal

- The SiriusXM Connect Vehicle Tuner is having difficulty receiving the SiriusXM satellite signal.
 - Verify that your vehicle is outdoors with a clear view of the southern sky.
 - Verify that the SiriusXM magnetic mount antenna is mounted on a metal surface on the outside of the vehicle.
 - Move the SiriusXM antenna away from any obstructions.

No Content

- TuneScan™ is not available.
 - Perform the operation with another preset channel.

Channel Not Available

- The channel that you have requested is not a valid SiriusXM channel.
 - Visit www.siriusxm.com for more information about the SiriusXM channel lineup.

Subscription Updated Press Enter to Continue

- This product has detected a change in your SiriusXM subscription status.
 - Touch [Enter] to clear the message. In the U.S.A., visit www.siriusxm.com or call 1-866-635-2349 if you have questions about your subscription. In Canada, visit www.siriusxm.ca or call 1-877-438-9677 if you have questions about your subscription.

Channel Not Subscribed. Call SiriusXM to Subscribe.

- The channel that you have requested is not included in your SiriusXM subscription package.
 - Check the content of your SiriusXM subscription package.

In the U.S.A., visit www.siriusxm.com or call 1-866-635-2349 if you have questions about your subscription package or would like to subscribe to this channel. In Canada, visit www.siriusxm.ca or call 1-877-438-9677.

Channel Locked Please Enter the Lock Code

- Locked by the radio Parental Control feature.
 - Release the channel lock.

Memory Full

- The memory has become full while playback was paused.
 - Resume playback.

Memory Nearly Full

- The memory has become nearly full while playback was paused.
 - Resume playback.

There are no qualified TuneMix music channels in this band.

- There are no qualified TuneMix channels in this band.
 - Requires two or more qualified music channels to be stored as presets in the current band.

USB storage device

Error-02-9X/-DX

- Communication failed.
 - Turn the ignition switch OFF and back ON.
 - Disconnect the USB storage device.
 - Change to a different source. Then, return to the USB storage device.

Unplayable File

- There is no playable file in the USB storage device.

- Check that the files in the USB storage device are compatible with this product.
- Security for the connected USB storage device is enabled.
 - Follow the USB storage device instructions to disable security.

Skipped

- The connected USB storage device contains DRM protected files.
 - The protected files are skipped.

Protect

- All the files on the connected USB storage device are embedded with DRM.
 - Replace the USB storage device.

Incompatible USB

- The connected USB storage device is not supported by this product.
 - Disconnect your device and replace it with a compatible USB storage device.

Check USB

- The USB connector or USB cable has short-circuited.
 - Check that the USB connector or USB cable is not caught in something or damaged.
- The connected USB storage device consumes more than maximum allowable current.
 - Disconnect the USB storage device and do not use it. Turn the ignition switch to OFF, then to ACC or ON and then connect a compliant USB storage device.

HUB Error

- The connected USB hub is not supported by this product.
 - Directly connect the USB storage device to this product.

No Response

- This product cannot recognize the connected USB storage device.
 - Disconnect the device and replace it with another USB storage device.
- The USB connector or USB cable has short-circuited.
 - Check that the USB connector or USB cable is not caught in something or damaged.
- The connected USB storage device consumes more than maximum allowable current.
 - Disconnect the USB storage device and do not use it. Turn the ignition switch to OFF, then to ACC or ON and then connect a compliant USB storage device.
- The USB interface cable for iPhone has short-circuited.
 - Confirm that the USB interface cable for iPhone or USB cable is not caught in something or damaged.

Your device is not authorized to play this DivX protected video.

- This product cannot play copy-protected DivX files.
 - Select a file that can be played.

Audio Format not supported

- This type of file is not supported on this product.
 - Select a file that can be played.

iPhone

There was a problem communicating with your iPhone. Please reconnect.

- iPhone failure.
 - Disconnect the cable from the iPhone. Once the iPhone's main menu is displayed, reconnect the iPhone and reset it.
- The iPhone firmware version is old.
 - Update the iPhone version.

Apple CarPlay

Connection failed.

- Communication failed and the system is trying to connect.
- Wait for a while. Then, perform the actions below if the error message is still displayed.
 - Restart the iPhone.
 - Disconnect the cable from the iPhone, and then connect the iPhone again after a few seconds.
 - Turn the ignition switch to OFF and then to ON.

Please attach the GPS antenna in order to use Apple CarPlay over Wireless.

- This unit cannot properly detect the GPS signal from the GPS antenna.
 - Check the GPS antenna installation and connection. For details about the connection and installation, refer to the Installation Manual.

The speed sensor is disconnected. Please attach it.

- The speed sensor cannot detect any signal.
 - Check the speed signal cable connection. For details about the connection, refer to the Installation Manual.

Please attach the GPS antenna and the speed sensor in order to use Apple CarPlay over Wireless.

- This unit cannot detect the GPS signal from the GPS antenna and the speed signal from the speed sensor.
 - Check the connection and installation for both. For details about the connection and installation, refer to the Installation Manual.

If the error message is still displayed after performing the above action, please

contact your dealer or an authorized Pioneer Service Station.

Android Auto

Android Auto has stopped.

- The connected device is not compatible with Android Auto.
 - Check if the device is compatible with Android Auto.
- The startup of Android Auto failed for some reasons.
 - Disconnect the cable from the smartphone, and then connect the smartphone again after a few seconds.
 - Restart the smartphone.
 - Turn the ignition switch to OFF and then to ON.

Android Auto has stopped. Please adjust the time to match that of the Android phone, or check the screen of your Android phone when it is safe to do so.

- The time set in this product or the smartphone is not correct.
 - Set the correct time.

If the error message is still displayed after performing the above action, please contact your dealer or an authorized Pioneer Service Station.

Bluetooth pairing failed.

- The Bluetooth pairing failed for some reasons.
 - Pair this product with the device manually.

To use Android Auto, please stop your car and check your Android phone.

- The default settings are displayed on the screen of the Android Auto compatible device or images are not output from the Android Auto compatible device.
 - Park your vehicle in a safe place, and follow the instructions displayed on

the screen. If the error message is still displayed after performing on-screen instructions, please reconnect the device.

Detailed information for playable media

Compatibility

Common notes about the USB storage device

- Do not leave the USB storage device in any location with high temperatures.
- Depending on the kind of the USB storage device you use, this product may not recognize the storage device or files may not be played back properly.
- The text information of some audio and video files may not be correctly displayed.
- File extensions must be used properly.
- There may be a slight delay when starting playback of files on an USB storage device with complex folder hierarchies.
- Operations may vary depending on the kind of an USB storage device.
- It may not be possible to play some music files from USB because of file characteristics, file format, recorded application, playback environment, storage conditions, and so on.

USB storage device compatibility

- For details about USB storage device compatibility with this product, refer to Specifications (page 137).
- Protocol: bulk
- You cannot connect a USB storage device to this product via a USB hub.
- Partitioned USB storage device is not compatible with this product.
- Firmly secure the USB storage device when driving. Do not let the USB storage

device fall onto the floor, where it may become jammed under the brake or gas pedal.

- There may be a slight delay when starting playback of audio files encoded with image data.
- Some USB storage devices connected to this product may generate noise on the radio.
- Do not connect anything other than the USB storage device.

The sequence of audio files on USB storage device.

For USB storage device, the sequence is different from that of USB storage device.

Handling guidelines and supplemental information

- Copyright protected files cannot be played back.

Common notes about DivX files

Notes specific to DivX files

- Only DivX files downloaded from DivX partner sites are guaranteed for proper operation. Unauthorized DivX files may not operate properly.
- This product corresponds to a DivX file display of up to 1 590 minutes 43 seconds. Search operations beyond this time limit are prohibited.
- For details on the DivX video versions that can be played on this product, refer to Specifications (page 137).
- For more details about DivX, visit the following site: <https://www.divx.com/>

Media compatibility chart

General

- Maximum playback time of audio file stored on an USB storage device: 8 h (480 minutes)

USB storage device

CODEC FORMAT	MP3, WMA, WAV, AAC, FLAC, DSD, AVI, MPEG-PS, MPEG-TS, MP4, 3GP, MKV, MOV, ASF, FLV, M4V
--------------	---

MP3 compatibility

- Ver. 2.x of ID3 tag is prioritized when both Ver. 1.x and Ver. 2.x exist.
- This product is not compatible with the following: MP3i (MP3 interactive), mp3 PRO, m3u playlist

SAMPLING FREQUENCY	8 kHz to 48 kHz
TRANSMISSION RATE	8 kbps to 320 kbps (CBR)/VBR
ID3 TAG	Folder Browse mode ver.1.0/1.1/2.2/2.3/2.4 Music Browse mode ver.2.2/2.3/2.4

WMA compatibility

- This product is not compatible with the following: Windows Media™ Audio 9.2 Professional, Lossless, Voice

SAMPLING FREQUENCY	32 kHz to 48 kHz
TRANSMISSION RATE	8 kbps to 320 kbps (CBR)/VBR

WAV compatibility

- The sampling frequency shown in the display may be rounded.

SAMPLING FREQUENCY	16 kHz to 192 kHz
QUANTIZATION BIT RATE	8 bit/16 bit/24 bit/32 bit (int only)

AAC compatibility

- This product plays back AAC files encoded by iTunes.

SAMPLING FREQUENCY	8 kHz to 48 kHz
TRANSMISSION RATE	16 kbps to 320 kbps (CBR)

FLAC compatibility

SAMPLING FREQUENCY	8 kHz to 192 kHz
QUANTIZATION BIT RATE	8 bit/16 bit/24 bit

DSD compatibility

SAMPLING FREQUENCY	DSD64: 2.8 MHz DSD128: 5.6 MHz
QUANTIZATION BIT RATE	1 bit

DivX compatibility

- This product is not compatible with the following: DivX Ultra format, DivX files without video data, DivX files encoded with LPCM (Linear PCM) audio codec.
- Some special operations may be prohibited because of the composition of DivX files.

USB storage device

EXTENSION	.divx, .avi
MAX RESOLUTION	720 × 576

Video files compatibility

- Files may not be played back properly depending on the environment in which the file was created or on the contents of the file.
- This product is not compatible with packet write data transfer.
- This product can recognize up to 32 characters, beginning with the first character, including extension for the file and folder name. Depending on the display area, this product may try to

display them with a reduced font size. However, the maximum number of the characters that you can display varies according to the width of each character, and of the display area.

- Folder selection sequence or other operations may be altered, depending on the order in which files are saved to the USB storage device.
- Regardless of the length of blank section between the songs of original recording, compressed audio files play with a short pause between songs.
- Files may not be able to be played back depending on the bit rate.
- The maximum resolution depends on the compatible video codec.
- This product's display does not have Full HD rendering capability.

.avi

Compatible video codec	MPEG4, DivX, H.264, H.263
Maximum resolution	1 920 × 1 080
Maximum frame rate	30 fps

.mpg/.mpeg

Compatible video codec	MPEG2
Maximum resolution	720 × 576
Maximum frame rate	30 fps

.divx

Compatible video codec	DivX
Maximum resolution	720 × 576
Maximum frame rate	30 fps

.mp4

Compatible video codec	MPEG4, H.264, H.263
Maximum resolution	1 920 × 1 080
Maximum frame rate	30 fps

.3gp

Compatible video codec	H.263
------------------------	-------

Maximum resolution	1 920 × 1 080
Maximum frame rate	30 fps

.mkv

Compatible video codec	MPEG4, H.264, VC-1
Maximum resolution	1 920 × 1 080
Maximum frame rate	30 fps

.mov

Compatible video codec	MPEG4, H.264, H.263
Maximum resolution	1 920 × 1 080
Maximum frame rate	30 fps

.flv

Compatible video codec	H.264
Maximum resolution	1 920 × 1 080
Maximum frame rate	30 fps

.wmv/.asf

Compatible video codec	VC-1
Maximum resolution	1 920 × 1 080
Maximum frame rate	30 fps

.m4v

Compatible video codec	MPEG4, H.264, H.263
Maximum resolution	1 920 × 1 080
Maximum frame rate	30 fps

.ts/.m2ts/.mts

Compatible video codec	MPEG4, H.264, MPEG2
Maximum resolution	1 920 × 1 080
Maximum frame rate	30 fps

Example of a hierarchy

NOTE

This product assigns folder numbers. The user cannot assign folder numbers.

Bluetooth

The *Bluetooth*® word mark and logos are registered trademarks owned by Bluetooth SIG, Inc. and any use of such marks by PIONEER CORPORATION is under license. Other trademarks and trade names are those of their respective owners.

USB Type-C

USB Type-C® and USB-C® are registered trademarks of USB Implementers Forum.

HDMI

HDMI™
HIGH-DEFINITION MULTIMEDIA INTERFACE

The terms HDMI and HDMI High-Definition Multimedia Interface, and the HDMI Logo are trademarks or registered trademarks of HDMI Licensing Administrator, Inc.

SiriusXM® Satellite Radio

(((SiriusXM)))
READY

SiriusXM and all related marks and logos are trademarks of Sirius XM Radio, Inc. All rights reserved.

Wi-Fi

Wi-Fi® is a registered trademark of Wi-Fi Alliance®.

Wi-Fi Protected Setup™ is a trademark of Wi-Fi Alliance®.



The Wi-Fi CERTIFIED™ Logo and the Wi-Fi Protected Setup™ Logo are certification marks of Wi-Fi Alliance®.

HD Radio™ Technology

HD Radio Technology manufactured under license from iBiquity Digital Corporation. U.S. and Foreign Patents. For patents see <http://dts.com/patents>. HD Radio and the HD, HD Radio, and "ARC" logos are registered trademarks or trademarks of iBiquity Digital Corporation in the United States and/or other countries.

Dolby Digital

This product will down-mix Dolby Digital signals internally and the sound will be output in stereo.

- Manufactured under license from Dolby Laboratories. Dolby and the double-D symbol are trademarks of Dolby Laboratories.



WMA

Windows Media is either a registered trademark or trademark of Microsoft Corporation in the United States and/or other countries.

- This product includes technology owned by Microsoft Corporation and cannot be used or distributed without a license from Microsoft Licensing, Inc.

FLAC

Copyright © 2000-2009 Josh Coalson
Copyright © 2011-2013 Xiph.Org
Foundation

Redistribution and use in source and binary forms, with or without modification, are permitted provided that the following conditions are met:

- Redistributions of source code must retain the above copyright notice, this list of conditions and the following disclaimer.
- Redistributions in binary form must reproduce the above copyright notice, this list of conditions and the following disclaimer in the documentation and/or other materials provided with the distribution.
- Neither the name of the Xiph.org Foundation nor the names of its contributors may be used to endorse or promote products derived from this software without specific prior written permission.

THIS SOFTWARE IS PROVIDED BY THE COPYRIGHT HOLDERS AND CONTRIBUTORS "AS IS" AND ANY EXPRESS OR IMPLIED WARRANTIES, INCLUDING, BUT NOT LIMITED TO, THE IMPLIED

WARRANTIES OF MERCHANTABILITY AND FITNESS FOR A PARTICULAR PURPOSE ARE DISCLAIMED. IN NO EVENT SHALL THE FOUNDATION OR CONTRIBUTORS BE LIABLE FOR ANY DIRECT, INDIRECT, INCIDENTAL, SPECIAL, EXEMPLARY, OR CONSEQUENTIAL DAMAGES (INCLUDING, BUT NOT LIMITED TO, PROCUREMENT OF SUBSTITUTE GOODS OR SERVICES; LOSS OF USE, DATA, OR PROFITS; OR BUSINESS INTERRUPTION) HOWEVER CAUSED AND ON ANY THEORY OF LIABILITY, WHETHER IN CONTRACT, STRICT LIABILITY, OR TORT (INCLUDING NEGLIGENCE OR OTHERWISE) ARISING IN ANY WAY OUT OF THE USE OF THIS SOFTWARE, EVEN IF ADVISED OF THE POSSIBILITY OF SUCH DAMAGE.

DivX



DivX® Home Theater Certified devices have been tested for high-quality DivX Home Theater video playback (including .avi, .divx). When you see the DivX logo, you know you have the freedom to play your favorite videos.

DivX®, DivX Certified® and associated logos are trademarks of DivX, LLC and are used under license.

This DivX Certified® device can play DivX® Home Theater video files up to 576p (including .avi, .divx).

Download free software at www.divx.com to create, play and cast digital videos.

AAC

AAC is short for Advanced Audio Coding and refers to an audio compression technology standard used with MPEG-2 and MPEG-4. Several applications can be used to encode AAC files, but file formats and extensions differ depending on the

application which is used to encode. This unit plays back AAC files encoded by iTunes.

High-Resolution Audio



The product with this logo is conformed to High-Resolution Audio standard defined by Japan Audio Society. This logo is used under license from Japan Audio Society. In order to listen music with Hi-Res sound quality, all components complied with High-Resolution Audio Standard of Japan Audio Society are recommended to use.

Google, Google Play, Android

Google, Google Play and Android are trademarks of Google LLC.

Android Auto

androidauto

Android Auto is a trademark of Google LLC.

Detailed information regarding connected iPhone devices

- Pioneer accepts no responsibility for data lost from an iPhone, even if that data is lost while using this product. Please back up your iPhone data regularly.
- Do not leave the iPhone in direct sunlight for extended amounts of time. Extended exposure to direct sunlight can result in iPhone malfunction due to the resulting high temperature.
- Do not leave the iPhone in any location with high temperatures.
- Firmly secure the iPhone when driving. Do not let the iPhone fall onto the floor, where it may become jammed under the brake or gas pedal.
- For details, refer to the iPhone manuals.

iPhone and Lightning®



Use of the Made for Apple badge means that an accessory has been designed to connect specifically to the Apple product(s) identified in the badge, and has been certified by the developer to meet Apple performance standards. Apple is not responsible for the operation of this device or its compliance with safety and regulatory standards. Please note that the use of this accessory with an Apple product may affect wireless performance. iPhone and Lightning are trademarks of Apple Inc., registered in the U.S. and other countries.

App Store

App Store is a service mark of Apple Inc.

iOS

iOS is a trademark on which Cisco holds the trademark right in the US and certain other countries.

iTunes

iTunes is a trademark of Apple Inc., registered in the U.S. and other countries.

Apple Music

Apple Music is a trademark of Apple Inc., registered in the U.S. and other countries.

Apple CarPlay



Apple CarPlay is a trademark of Apple Inc. Use of the Works with Apple badge means that an accessory has been designed to work specifically with the technology identified in the badge and has been certified by the developer to meet Apple performance standards.

Siri

Works with Siri through the microphone.

Compatible iPhone models

- iPhone XS

- iPhone XS Max
- iPhone XR
- iPhone X
- iPhone 8
- iPhone 8 Plus
- iPhone 7
- iPhone 7 Plus
- iPhone SE
- iPhone 6s
- iPhone 6s Plus
- iPhone 6
- iPhone 6 Plus
- iPhone 5s

Depending on the iPhone models, it may not be compatible with some AV sources. For details about iPhone compatibility with this product, refer to the information on our website.

Amazon, Alexa, Kindle, Audible, Echo, Amazon Music



Amazon, Alexa, Kindle, Audible, Echo, Amazon Music and all related logos are trademarks of Amazon.com, Inc. or its affiliates.

METRA



Gracenote

Gracenote, the Gracenote logo and logotype are either a registered trademark or a trademark of Gracenote, Inc. in the United States and/or other countries.

Using app-based connected content

Important

Requirements to access app-based connected content services using this product:

- Latest version of the Pioneer compatible connected content application(s) for the smartphone, available from the service provider, downloaded to your smartphone.
- A current account with the content service provider.
- Smartphone Data Plan.
Note: if the Data Plan for your smartphone does not provide for unlimited data usage, additional charges from your carrier may apply for accessing app-based connected content via 3G, EDGE and/or LTE (4G) networks.
- Connection to the Internet via 3G, EDGE, LTE (4G) or Wi-Fi network.
- Optional Pioneer adaptor cable connecting your iPhone to this product.

Limitations:

- Access to app-based connected content will depend on the availability of cellular and/or Wi-Fi network coverage for the purpose of allowing your smartphone to connect to the Internet.
- Service availability may be geographically limited to the region. Consult the connected content service provider for additional information.

- Ability of this product to access connected content is subject to change without notice and could be affected by any of the following: compatibility issues with future firmware versions of smartphone; compatibility issues with future versions of the connected content application(s) for the smartphone; changes to or discontinuation of the connected Content application(s) or service by its provider.
- Pioneer is not liable for any issues that may arise from incorrect or flawed app-based content.
- The content and functionality of the supported applications are the responsibility of the App providers.
- In Apple CarPlay and Android Auto, functionality through the product is limited while driving, with available functions determined by the App providers.
- Availability of Apple CarPlay and Android Auto functionalities is determined by the App provider, and not determined by Pioneer.
- Apple CarPlay and Android Auto allow access to applications other than those listed (subject to limitations while driving), but the extent to which content can be used is determined by the App providers.

Notice regarding video viewing

Remember that use of this system for commercial or public viewing purposes may constitute an infringement on the author's rights as protected by the Copyright Law.

Using the LCD screen correctly

Handling the LCD screen

- When the LCD screen is subjected to direct sunlight for a long period of time, it will become very hot, resulting in possible damage to the LCD screen. When not using this product, avoid exposing it to direct sunlight as much as possible.
- The LCD screen should be used within the temperature ranges shown in Specifications on page 137.
- Do not use the LCD screen at temperatures higher or lower than the operating temperature range, because the LCD screen may not operate normally and could be damaged.
- The LCD screen is exposed in order to increase its visibility within the vehicle. Please do not press strongly on it as this may damage it.
- Do not push the LCD screen with excessive force as this may scratch it.
- Never touch the LCD screen with anything besides your finger when operating the touch panel functions. The LCD screen can scratch easily.

Liquid crystal display (LCD) screen

- If the LCD screen is near the vent of an air conditioner, make sure that air from the air conditioner is not blowing on it. Heat from the heater may break the LCD screen, and cool air from the cooler may cause moisture to form inside this product, resulting in possible damage.
- Small black dots or white dots (bright dots) may appear on the LCD screen.

These are due to the characteristics of the LCD screen and do not indicate a malfunction.

- The LCD screen will be difficult to see if it is exposed to direct sunlight.
- When using a cellular phone, keep the antenna of the cellular phone away from the LCD screen to prevent disruption of the video in the form of disturbances such as spots or colored stripes.

Maintaining the LCD screen

- When removing dust from or cleaning the LCD screen, first turn this product off and then wipe the screen with a soft dry cloth.
- When wiping the LCD screen, take care not to scratch the surface. Do not use harsh or abrasive chemical cleaners.

LED (light-emitting diode) backlight

- A light emitting diode is used inside the display to illuminate the LCD screen.
- At low temperatures, using the LED backlight may increase image lag and degrade the image quality because of the characteristics of the LCD screen. Image quality will improve with an increase in temperature.
 - The product lifetime of the LED backlight is more than 10 000 hours. However, it may decrease if used in high temperatures.
 - If the LED backlight reaches the end of its product lifetime, the screen will become dimmer and the image will no longer be visible. In that case, please consult your dealer or the nearest authorized Pioneer Service Station.

Specifications

General

Rated power source:

14.4 V DC (10.8 V to 15.1 V allowable)

Grounding system:

Negative type

Maximum current consumption:

10.0 A

Dimensions (W × H × D):

(DMH-WT8600NEX)

Chassis (D):

178 mm × 50 mm × 165 mm (7 in. × 2 in. × 6-1/2 in.)

Nose:

170 mm × 46 mm × 7.5 mm (6-3/4 in. × 1-3/4 in. × 1/4 in.)

Monitor:

257 mm × 147 mm × 37 mm (10-1/8 in. × 5-3/4 in. × 1-1/2 in.)

(DMH-WT7600NEX)

Chassis (D):

178 mm × 50 mm × 165 mm (7 in. × 2 in. × 6-1/2 in.)

Nose:

170 mm × 46 mm × 7.5 mm (6-3/4 in. × 1-3/4 in. × 1/4 in.)

Monitor:

231 mm × 131 mm × 37 mm (9-1/8 in. × 5-1/8 in. × 1-1/2 in.)

(DMH-WC6600NEX)

Body:

178 mm × 50 mm × 135 mm (7 in. × 2 in. × 5-3/8 in.)

Monitor:

230 mm × 130 mm × 29 mm (9 in. × 5-1/8 in. × 1-1/8 in.)

(DMH-W4660NEX/DMH-W4600NEX)

Chassis (D):

178 mm × 100 mm × 87 mm (7 in. × 3-7/8 in. × 3-3/8 in.)

Nose:

171 mm × 97 mm × 3 mm (6-3/4 in. × 3-7/8 in. × 1/8 in.)

Weight:

(DMH-WT8600NEX)

Body:

1.4 kg (3.1 lbs)

Monitor:

0.9 kg (2.0 lbs)

(DMH-WT7600NEX)

Body:

1.4 kg (3.1 lbs)

Monitor:

0.7 kg (1.5 lbs)

(DMH-WC6600NEX)

Body:

0.8 kg (1.8 lbs)

Monitor:

0.8 kg (1.8 lbs)

(DMH-W4660NEX/DMH-W4600NEX)

0.9 kg (2.0 lbs)

Display

Screen size/aspect ratio:

(DMH-WT8600NEX)

10.1 inch wide/16:9 (effective display area: 223.68 mm × 125.82 mm) (8-3/4 in. × 4-7/8 in.)

(DMH-WT7600NEX)

9.0 inch wide/16:9 (effective display area: 198.72 mm × 111.78 mm) (7-3/4 in. × 4-3/8 in.)

(DMH-WC6600NEX)

9.0 inch wide/16:9 (effective display area: 198.72 mm × 111.78 mm) (7-3/4 in. × 4-3/8 in.)

(DMH-W4660NEX/DMH-W4600NEX)

6.78 inch wide/16:9 (effective display area: 152.4 mm × 80.208 mm) (6 in. × 3-1/8 in.)

Pixels:

(DMH-WT8600NEX/DMH-WT7600NEX/DMH-WC6600NEX)

1 280 (Width) × 720 (Height) × 3 (RGB)

(DMH-W4660NEX/DMH-W4600NEX)

800 (Width) × 480 (Height) × 3 (RGB)

Display method:

TFT Active matrix driving

Color system:
PAL/NTSC/PAL-M/PAL-N/SECAM
compatible
Temperature range:
-10 °C to +60 °C (+14 °F to +140 °F)

Audio

Maximum power output:
• 50 W × 4
• 50 W × 2 ch/4 Ω + 70 W × 1 ch/2 Ω (for subwoofer)
Continuous power output:
22 W × 4 (50 Hz to 15 kHz, 5 %THD, 4 Ω LOAD, Both Channels Driven)
Load impedance:
4 Ω (4 Ω to 8 Ω [2 Ω for 1 ch] allowable)
Preout output level (max): 4.0 V
Equalizer (13-Band Graphic Equalizer):
Frequency:
50 Hz/80 Hz/125 Hz/200 Hz/315 Hz/
500 Hz/800 Hz/1.25 kHz/2 kHz/3.15
kHz/5 kHz/8 kHz/12.5 kHz
Gain: ±12 dB (2 dB/step)
<Standard Mode>
HPF: ON/OFF
Frequency:
25 Hz/31.5 Hz/40 Hz/50 Hz/63 Hz/80
Hz/100 Hz/125 Hz/160 Hz/200 Hz/250
Hz
Slope:
-6 dB/oct, -12 dB/oct, -18 dB/oct, -24
dB/oct
LPF (Subwoofer): ON/OFF
Frequency:
25 Hz/31.5 Hz/40 Hz/50 Hz/63 Hz/80
Hz/100 Hz/125 Hz/160 Hz/200 Hz/250
Hz
Slope:
-6 dB/oct, -12 dB/oct, -18 dB/oct, -24
dB/oct, -30 dB/oct, -36 dB/oct
Phase: Normal/Reverse
Time alignment:
0 to 210 inch (0.6 inch/step)
Speaker level:
+10 dB to -24 dB (1 dB/step)
<Network Mode>

HPF (High): ON/OFF
Frequency:
1.25 kHz/1.6 kHz/2 kHz/2.5 kHz/3.15
kHz/4 kHz/5 kHz/6.3 kHz/8 kHz/10 kHz/
12.5 kHz
Slope:
-6 dB/oct, -12 dB/oct, -18 dB/oct, -24
dB/oct
Phase (High): Normal/Reverse
HPF (Mid): ON/OFF
Frequency:
25 Hz/31.5 Hz/40 Hz/50 Hz/63 Hz/80
Hz/100 Hz/125 Hz/160 Hz/200 Hz/250
Hz
Slope:
-6 dB/oct, -12 dB/oct, -18 dB/oct, -24
dB/oct
LPF (Mid): ON/OFF
Frequency:
1.25 kHz/1.6 kHz/2 kHz/2.5 kHz/3.15
kHz/4 kHz/5 kHz/6.3 kHz/8 kHz/10 kHz/
12.5 kHz
Slope:
-6 dB/oct, -12 dB/oct, -18 dB/oct, -24
dB/oct
Phase (Mid): Normal/Reverse
LPF (Subwoofer): ON/OFF
Frequency:
25 Hz/31.5 Hz/40 Hz/50 Hz/63 Hz/80
Hz/100 Hz/125 Hz/160 Hz/200 Hz/250
Hz
Slope:
-6 dB/oct, -12 dB/oct, -18 dB/oct, -24
dB/oct, -30 dB/oct, -36 dB/oct
Phase (Subwoofer): Normal/Reverse
Time alignment:
0 to 210 inch (0.6 inch/step)
Speaker level:
+10 dB to -24 dB (1 dB/step)

USB

USB standard spec:
USB 1.1, USB 2.0 full speed, USB 2.0 high
speed
Max current supply: 3.0 A

USB Class:

MSC (Mass Storage Class), MTP (Media Transfer Protocol)

File system: FAT16, FAT32, NTFS

<USB audio>

MP3 decoding format:

MPEG-1 & 2 & 2.5 Audio Layer 3

WMA decoding format:

Ver. 7, 7.1, 8, 9, 10, 11, 12 (2 ch audio)
(Windows Media Player)

AAC decoding format:

MPEG-4 AAC (iTunes encoded only) (Ver. 12.5 and earlier)

FLAC decoding format (MSC Mode only)

WAV signal format (MSC Mode only):

Linear PCM

Sampling frequency:

16 kHz/22.05 kHz/24 kHz/32 kHz/44.1 kHz/48 kHz/96 kHz/192 kHz

DSD64, DSD128 format (MSC Mode only)

<USB image>

JPEG decoding format (MSC Mode only):

.jpeg, .jpg, .jpe

Pixel Sampling: 4:2:2, 4:2:0

Decode Size:

MAX: 7 680 (H) × 8 192 (W)

MIN: 32 (H) × 32 (W)

PNG decoding format (MSC Mode only):

.png

Decode Size:

MAX: 576 (H) × 720 (W)

MIN: 32 (H) × 32 (W)

BMP decoding format (MSC Mode only):

.bmp

Decode Size:

MAX: 936 (H) × 1 920 (W)

MIN: 32 (H) × 32 (W)

<USB video>

H.264 video decoding format:

Base Line Profile, Main Profile, High Profile

H.263 video decoding format:

Base Line Profile 0/3

VC-1 video decoding format:

Simple Profile, Main Profile, Advanced Profile

DivX:

Home Theater

MPEG4 video decoding format:

Simple Profile, Advanced Simple Profile

MPEG2 video decoding format:

Main Profile

Bluetooth

Version:

Bluetooth 4.2 certified

Output power:

+4 dBm Max. (Power class 2)

BLE (Bluetooth Low Energy) output power:

+3.5 dBm Max.

Frequency band(s):

2 402 MHz to 2 480 MHz

Bluetooth profiles:

HFP (Hands Free Profile) 1.7

PBAP (Phone Book Access Profile) 1.2

A2DP (Advanced Audio Distribution Profile) 1.3

AVRCP (Audio/Video Remote Control Profile) 1.6.1

SPP (Serial Port Profile) 1.2

AVCTP (Audio/Video Control Transport Protocol) 1.4

AVDTP (Audio/Video Distribution Transport Protocol) 1.3

DID (Device ID Profile) 1.3

GAVDP (Generic Audio/Video Distribution Profile) 1.3

IOP (Interoperability Test Specification)

OPP (Object Push Profile)

RFCOMM (RFCOMM with TS 07.10) 1.2

FM tuner

Frequency range:

87.9 MHz to 107.9 MHz

Usable sensitivity:

12 dBf (1.1 μ V/75 Ω , mono, S/N: 30 dB)

Signal-to-noise ratio:

(DMH-WT8600NEX/DMH-WT7600NEX/
DMH-WC6600NEX/DMH-W4660NEX)

65 dB (digital broadcasting) (IHF-A network)

65 dB (analog broadcasting) (IHF-A network)

(DMH-W4600NEX)
65 dB (IHF-A network)

AM tuner

Frequency range:

530 kHz to 1 710 kHz

Usable sensitivity:

25 μ V (S/N: 20 dB)

Signal-to-noise ratio:

(DMH-WT8600NEX/DMH-WT7600NEX/

DMH-WC6600NEX/DMH-W4660NEX)

60 dB (digital broadcasting) (IHF-A network)

60 dB (analog broadcasting) (IHF-A network)

(DMH-W4600NEX)

60 dB (IHF-A network)

Wi-Fi

Frequency channel:

1 to 11 ch (2.4 GHz)

149, 151, 155 ch (5 GHz)

Security:

OPEN/WEP/WPA (personal)/WPA2 (personal)

GPS

GNSS receiver

System:

GPS L1C/Ac, SBAS L1C/A, GLONASS

L1OF, Galileo E1B/C

SPS (Standard Positioning Service)

Reception system:

72 channel Multi-channel reception system

Reception frequency:

1 575.42 MHz/1 602 MHz

Sensitivity:

-140 dBm (typ)

Frequency:

Approx. once per second

GPS antenna

Antenna:

Micro strip flat antenna/right-handed helical polarization

Antenna cable:

3.55 m (11ft. 7in.)

Dimensions (W x H x D):

33 mm x 14.7 mm x 36 mm (1-1/4 in. x

1/2 in. x 1-3/8 in.)

Weight:

73.7 g (0.2 lbs)

CTA2006 Specifications



Power output:

14 W RMS x 4 Channels (4 Ω and \leq 1 % THD+N)

S/N ratio:

90 dB (IHF-A)

NOTE

Specifications and design are subject to possible modifications without notice due to improvements.

Register your product at

<https://www.pioneerelectronics.com/PUSA/>

in Canada **<https://www.pioneerelectronics.ca/POCEN/>**

PIONEER CORPORATION

28-8, Honkomagome 2-chome, Bunkyo-ku,
Tokyo 113-0021, Japan

PIONEER ELECTRONICS (USA) INC.

P.O. Box 1540, Long Beach, California 90801-1540, U.S.A.
TEL: (800) 421-1404

PIONEER EUROPE NV

Haven 1087, Keetberglaan 1, B-9120 Melsele, Belgium/Belgique
TEL: (0) 3/570.05.11

PIONEER ELECTRONICS ASIACENTRE PTE. LTD.

2 Jalan Kilang Barat, #07-01, Singapore 159346
TEL: 65-6378-7888

PIONEER ELECTRONICS AUSTRALIA PTY. LTD.

5 Arco Lane, Heatherton, Victoria, 3202 Australia
TEL: (03) 9586-6300

PIONEER ELECTRONICS DE MÉXICO S.A. DE C.V.

Bld. Manuel Ávila Camacho 138, 10 piso
Col.Lomas de Chapultepec, México, D.F. 11000
Tel: 52-55-9178-4270, Fax: 52-55-5202-3714

先鋒股份有限公司

台北市內湖區瑞光路407號8樓
電話：886-(0)2-2657-3588

先鋒電子（香港）有限公司

香港九龍長沙灣道909號5樓
電話：852-2848-6488

© 2020 PIONEER CORPORATION. All rights reserved.

<OPM_DMHWC6600NEXUC_EN_B> UC

Pioneer

DMH-WT8600NEX

DMH-WT7600NEX

DMH-WC6600NEX

DMH-W4660NEX

DMH-W4600NEX

RDS AV RECEIVER

RÉCEPTEUR AV RDS

RECEPTOR AV RDS

Installation Manual
Manuel d'installation
Manual de instalación

English

Français

Español

Important safety information

WARNING

Rear visibility systems (backup cameras) are required in certain new vehicles sold in the U.S. and Canada. U.S. regulations began according to a two year phase-in on May 1, 2016, and both the U.S. and Canada require that all such vehicles manufactured on or after May 1, 2018 have rear visibility systems. **Owners of vehicles equipped with compliant rear visibility systems should not install or use this product in a way that alters or disables that system's compliance with applicable regulations.** If you are unsure whether your vehicle has a rear visibility system

subject to the U.S. or Canadian regulations, please contact the vehicle manufacturer or dealer.

If your vehicle has a compliant backup camera that displays the backup view through the factory receiver, do not use the Pioneer receiver unless it is connected to and displays the same view as the factory backup camera. Connection to the factory backup camera will require an adaptor, sold separately. Not all vehicles may be able to connect. Please check with a qualified professional installer for installation options specific to your vehicle.

Connection

Precautions

Your new product and this manual

- Do not operate this product, any applications, or the rear view camera option (if purchased) if doing so will divert your attention in any way from the safe operation of your vehicle. Always observe safe driving rules and follow all existing traffic regulations. If you experience difficulty in operating this

product, pull over, park your vehicle in a safe location and apply the parking brake before making the necessary adjustments.

- Do not install this product where it may (i) obstruct the driver's vision, (ii) impair the performance of any of the vehicle's operating systems of safety features, including airbags, hazard lamp buttons, or (iii) impair the driver's ability to safely operate the vehicle. In some cases, it may not be possible to install this product because of the vehicle type or the shape of the vehicle interior.

Important safeguards

WARNING

Pioneer does not recommend that you install this product yourself. This product is designed for professional installation only. We recommend that only authorized Pioneer service personnel, who have special training and experience in mobile electronics, set up and install this product. **NEVER SERVICE THIS PRODUCT YOURSELF.** Installing or servicing this product and its connecting cables may expose you to the risk of electric shock or other hazards, and can cause damage to this product that is not covered by warranty.

Precautions before connecting the system

CAUTION

- Secure all wiring with cable clamps or electrical tape. Do not allow any bare wiring to remain exposed.
- Do not directly connect the yellow lead of this product to the vehicle battery. If the lead is directly connected to the battery, engine vibration may eventually cause the insulation to fail at the point where the wire passes from the passenger compartment into the engine compartment. If the yellow lead's insulation tears as a result of contact with metal parts, short-circuiting can occur, resulting in considerable danger.
- It is extremely dangerous to allow cables to become wound around the steering column or shift lever. Be sure to install this product, its cables, and wiring away in such so that they will not obstruct or hinder driving.
- Make sure that the cables and wires will not interfere with or become caught in

any of the vehicle's moving parts, especially the steering wheel, shift lever, parking brake, sliding seat tracks, doors, or any of the vehicle's controls.

- Do not route wires where they will be exposed to high temperatures. If the insulation heats up, wires may become damaged, resulting in a short circuit or malfunction and permanent damage to the product.
- Do not shorten any leads. If you do, the protection circuit (fuse holder, fuse resistor or filter, etc.) may fail to work properly.
- Never feed power to other electronic products by cutting the insulation of the power supply lead of this product and tapping into the lead. The current capacity of the lead will be exceeded, causing overheating.

Before installing this product

- Use this unit with a 12-volt battery and negative grounding only. Failure to do so may result in a fire or malfunction.
- To avoid shorts in the electrical system, be sure to disconnect the (-) battery cable before installation.

To prevent damage

WARNING

- When speaker output is used by 4 channels, use speakers over 50 W (Maximum input power) and between 4 Ω to 8 Ω (impedance value). Do not use 1 Ω to 3 Ω speakers for this unit.
- When rear speaker output is used by 2 Ω of subwoofer, use speakers over 70 W (Maximum input power).
*Please refer to connection for a connection method.

- The black lead is ground. When installing this unit or power amp (sold separately), make sure to connect the ground wire first. Ensure that the ground wire is properly connected to metal parts of the car's body. The ground wire of the power amp and the one of this unit or any other device must be connected to the car separately with different screws. If the screw for the ground wire loosens or falls out, it could result in fire generation of smoke or malfunction.

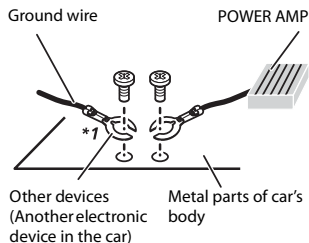

*1 Not supplied for this unit

- When replacing the fuse, be sure to only use a fuse of the rating prescribed on this product.
- When disconnecting a connector, pull the connector itself. Do not pull the lead, as you may pull it out of the connector.
- This product cannot be installed in a vehicle without ACC (accessory) position on the ignition switch.

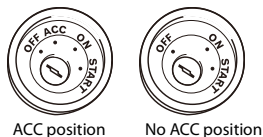

- To avoid short-circuiting, cover the disconnected lead with insulating tape. It is especially important to insulate all

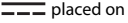
- unused speaker leads, which if left uncovered may cause a short circuit.
- For connecting a power amp or other devices to this product, refer to the manual for the product to be connected.
 - The graphical symbol  placed on the product means direct current.

Notice for the blue/white lead

- When the ignition switch is turned on (ACC ON), a control signal is output through the blue/white lead. Connect to an external power amp's system remote control terminal, the auto-antenna relay control terminal, or the antenna booster power control terminal (max. 300 mA 12 V DC). The control signal is output through the blue/white lead, even if the audio source is switched off.

Important

When this product is in [Power OFF] mode, the control signal is also turned off. If [Power OFF] mode is canceled, the control signal is output again and the antenna is extended with the auto antenna function (if the antenna is being used). Be careful so that the extended antenna does not come into contact with any obstacles.

Rear panel (main terminals)

▶ DMH-WT8600NEX/DMH-WT7600NEX/DMH-WC6600NEX

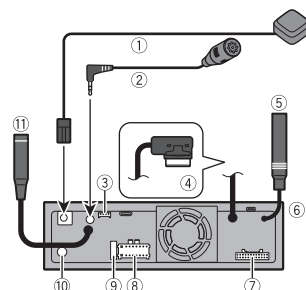

▶ DMH-W4660NEX/DMH-W4600NEX

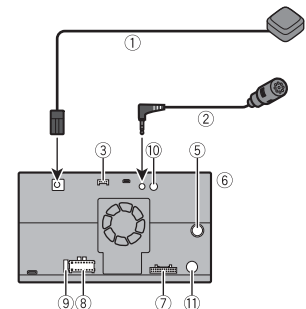

- ① GPS antenna 3.55 m (11 ft. 8 in.)
- ② Microphone 3 m (9 ft. 10-1/8 in.)
- ③ iDataLink or Metra adaptor input
Refer to the instruction manual for the iDataLink or Metra adaptor (sold separately).
- ④ Monitor cable connector*

- Connect to LCD screen.
- ⑤ Antenna jack
 - ⑥ This product
 - ⑦ Pre out supply
 - ⑧ Power supply
 - ⑨ Fuse (10A)
 - ⑩ Wired remote input
Hard-wired remote control adaptor can be connected (sold separately).
 - ⑪ SiriusXM Connect Vehicle Tuner
Refer to the instruction manual for SiriusXM Connect Vehicle Tuner (sold separately).
- * Monitor cable and connector are in the front panel. (DMH-W8600NEX, DMH-W7600NEX)

NOTES

- Before using and/or connecting the iDataLink Maestro adaptor (sold separately), you will need to first flash the Maestro module with the appropriate vehicle and head unit firmware. You can find the device number that is required for the activation on the followings (refer to the Operation Manual.):
 - The label on the packaging of this product
 - The label on this product
 - The [Firmware Information] screen
- When the iDataLink Maestro adaptor is connected, use the microphone of this unit to perform voice operations for Apple CarPlay, Android Auto, or Amazon Alexa.

Power cord

⚠ WARNING

IMPROPER CONNECTION MAY RESULT IN SERIOUS DAMAGE OR INJURY INCLUDING ELECTRICAL SHOCK, AND INTERFERENCE WITH THE OPERATION OF THE VEHICLE'S ANTILOCK BRAKING SYSTEM, AUTOMATIC TRANSMISSION AND SPEEDOMETER INDICATION.

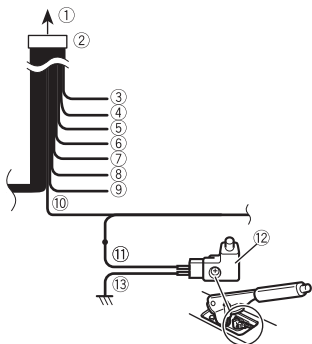

- ① To power supply
- ② Power cord
- ③ Yellow
- To terminal supplied with power regardless of ignition switch position.
- ④ Red
- To electric terminal controlled by ignition switch (12 V DC) ON/OFF
- ⑤ Orange/white
- To lighting switch terminal.
- ⑥ Black (ground)
- To vehicle (metal) body.
- ⑦ Violet/white
- Of the two lead wires connected to the back lamp, connect the one in which the voltage changes when the gear shift is in the REVERSE (R) position. This connection enables the unit to sense whether the car is moving forward or backward.
- ⑧ Pink
- Car speed signal input
- ⑨ Blue/white
- Connect to system control terminal of the power amp (max. 300 mA 12 V DC).
- ⑩ Light green
- Used to detect the ON/OFF status of the parking brake. This lead must be

connected to the power supply side of the parking brake switch.
If this connection is made incorrectly or omitted, certain functions of this product will be unusable.

- ⑪ Power supply side
- ⑫ Parking brake switch
- ⑬ Ground side

NOTE

The position of the speed detection circuit and the position of the parking brake switch vary depending on the vehicle model. For details, consult your authorized Pioneer dealer or an installation professional.

Speaker leads

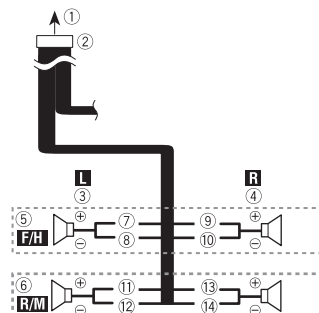

Perform these connections when using a subwoofer without the optional amplifier.

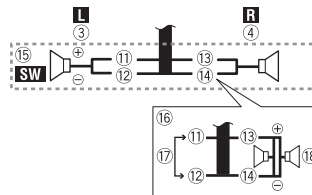

- ① To power supply
- ② Power cord
- ③ Left
- ④ Right
- ⑤ Front speaker (STD) or high range speaker (NW)
- ⑥ Rear speaker (STD) or middle range speaker (NW)
- ⑦ White
- ⑧ White/black
- ⑨ Gray
- ⑩ Gray/black
- ⑪ Green
- ⑫ Green/black
- ⑬ Violet
- ⑭ Violet/black
- ⑮ Subwoofer (4 Ω)
- ⑯ When using a subwoofer of 2 Ω, be sure to connect the subwoofer to the violet and violet/black leads. Do not connect anything to the green and green/black leads.
- ⑰ Not used.
- ⑱ Subwoofer (4 Ω) × 2

NOTES

- When a subwoofer is connected to this product instead of a rear speaker, change the rear output setting in the initial setting. The subwoofer output of this product is monaural. For details, refer to the Operation Manual.
- With a two-speaker system, do not connect anything to the speaker leads that are not connected to speakers.

Power amp (sold separately)

Important

The speaker leads are not used when this connection is in use.

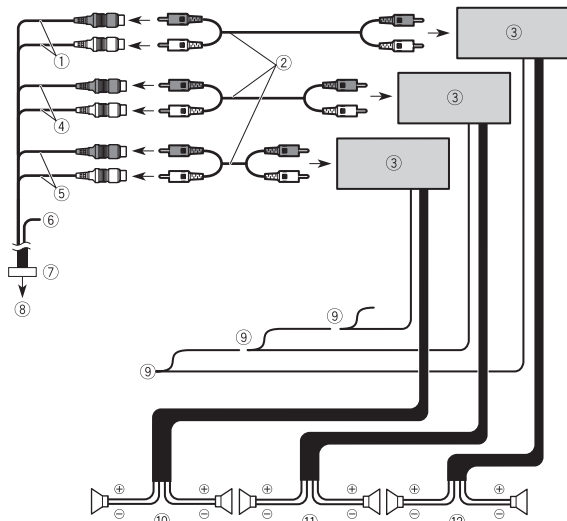

① Subwoofer output (**SUBWOOFER OUTPUT**) 23 cm (9 in.) (STD)

Low range output (NW)

② RCA cable (sold separately)

③ Power amp

④ Front output (**FRONT OUTPUT**) 15 cm (5-7/8 in.) (STD)

High range output (NW)

⑤ Rear output (**REAR OUTPUT**) 15 cm (5-7/8 in.) (STD)

Middle range output (NW)

⑥ Yellow/black (MUTE)

If you use an equipment with Mute function, wire this lead to the Audio Mute lead on that equipment. If not, keep the Audio Mute lead free of any connections.

⑦ Pre out cord

⑧ To pre out supply

⑨ System remote control

Connect to Blue/white cable (max. 300 mA 12 V DC).

⑩ Rear speaker (STD)
Middle range speaker (NW)

⑪ Front speaker (STD)
High range speaker (NW)

⑫ Subwoofer (STD)
Low range speaker (NW)

NOTE

Select the appropriate speaker mode between standard mode (STD) and network mode (NW). For details, refer to the Operation Manual.

iPhone® and smartphone

NOTES

- For details on how to connect an external device using a separately sold cable, refer to the manual for the cable.
- For details concerning the connection, operations and compatibility of the iPhone, refer to the Operation Manual.
- For details concerning the connection and operations of the smartphone, refer to the Operation Manual.
- The supplied USB Type-C® cable and the USB Type-C to USB Type-A adaptor are for connecting a USB storage device to this unit only. Do not use the cable and the adaptor for other products or purposes.

iPhone

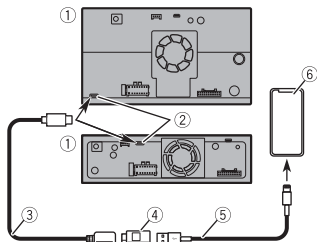

- 1 This product
- 2 USB Type-C port
- 3 USB Type-C cable 1.5 m (4 ft. 11 in.)
- 4 USB Type-C to USB Type-A adaptor
- 5 USB interface cable for iPhone (CD-IU52) (sold separately)
- 6 iPhone

TIP

When a USB Type-C to Lightning® connector cable (Apple Inc. product) (sold separately) is used to connect this unit to an iPhone that supports USB-PD, quick charging is performed for the iPhone.

NOTE

When you use a USB Type-C to Lightning connector cable (Apple Inc. product) (sold separately), follow the instructions provided with the cable.

Smartphone (Android™ device)

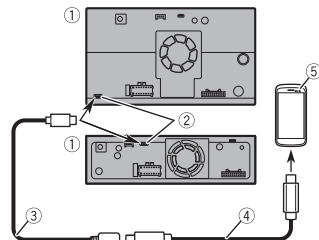

- 1 This product
- 2 USB Type-C port
- 3 USB Type-C cable 1.5 m (4 ft. 11 in.)
- 4 USB Type-C to USB Type-A interface cable (CD-CCU500) (sold separately)
- 5 Smartphone

TIPS

- Use the supplied USB Type-C to USB Type-A adaptor with a USB Type-A to micro USB B cable (CD-MU200) (sold separately) if your smartphone has a micro USB B port.
- When a USB Type-C to USB Type-C cable (sold separately) is used to connect this unit to a smartphone, quick charging is performed.

NOTE

If you use a cable other than those suggested in the illustration, the main unit may not function properly.

Camera

When you use the rear view camera, the rear view image is automatically switched from the video by moving the shift lever to **REVERSE (R)**. **Camera View** mode also allows you to check what is behind you while driving.

⚠ WARNING

USE INPUT ONLY FOR REVERSE OR MIRROR IMAGE REAR VIEW CAMERA. OTHER USE MAY RESULT IN INJURY OR DAMAGE.

⚠ CAUTION

- The screen image may appear reversed.
- With the rear view camera you can keep an eye on trailers, or back into a tight parking spot. Do not use for entertainment purposes.
- Objects in rear view may appear closer or more distant than in reality.
- The image area of full-screen images displayed while backing or checking the rear of the vehicle may differ slightly.

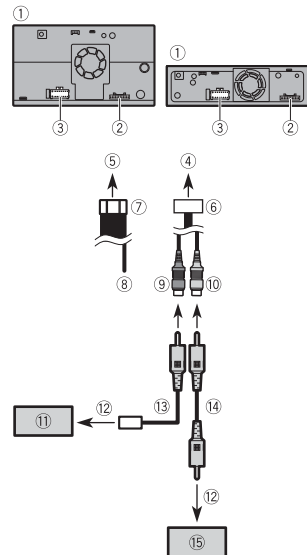

- 1 This product
- 2 Pre out supply
- 3 Power supply
- 4 To pre out supply
- 5 To power supply
- 6 Pre out cord
- 7 Power cord
- 8 Violet/white (**REVERSE-GEAR SIGNAL INPUT**)
- 9 Brown (**REAR VIEW CAMERA IN**) 23 cm (9 in.)
- 10 Yellow* (**SECOND CAMERA INPUT**) 23 cm (9 in.)
- 11 Rear view camera (ND-BC8) (sold separately)
- 12 To video output
- 13 RCA power supply cable (supplied with ND-BC8)

- ⑭ RCA cable (sold separately)
- ⑮ View camera (sold separately)
- * Not available for DMH-W4600NEX

NOTES

- Connect only the rear view camera to brown cable. Do not connect any other equipment.
- Some appropriate settings are required to use rear view cameras. For details, refer to the Operation Manual.

External video component

Using an AUX input

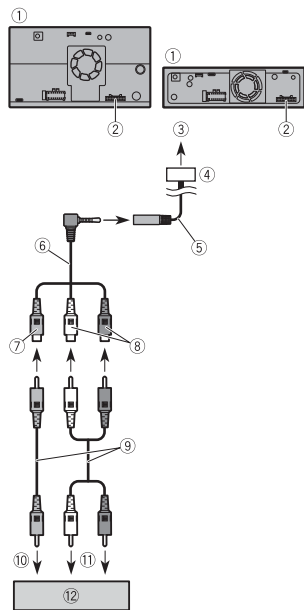

- ① This product
- ② Pre out supply
- ③ To pre out supply
- ④ Pre out cord
- ⑤ AUX input (**AUX IN**) 15 cm (5-7/8 in.)
- ⑥ Mini-jack AV cable (sold separately)
- ⑦ Yellow
- ⑧ Red, white

- ⑨ RCA cables (sold separately)
- ⑩ To video output
- ⑪ To audio output
- ⑫ External video component (sold separately)

NOTE

The appropriate setting is required to use the external video component. For details, refer to the Operation Manual.

CAUTION

Be sure to use a mini-jack AV cable (sold separately) for wiring. If you use other cables, the wiring position might differ resulting in disturbed images and sounds.

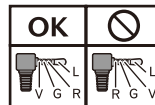

- L: Left audio (White)
- R: Right audio (Red)
- V: Video (Yellow)
- G: Ground

Using an HDMI input

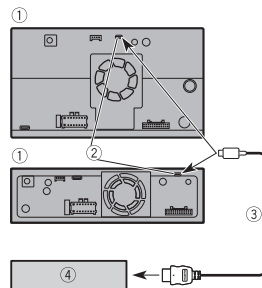

- ① This product
- ② Micro HDMI port
- ③ Micro HDMI to HDMI cable (sold separately)
- ④ HDMI device (sold separately)

Rear display

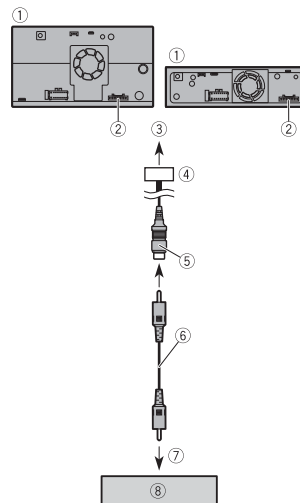

- ① This product
- ② Pre out supply
- ③ To pre out supply
- ④ Pre out cord
- ⑤ Yellow (**REAR MONITOR OUTPUT**) 30 cm (11-7/8 in.)
- ⑥ RCA cable (sold separately)
- ⑦ To Video input
- ⑧ Rear display with RCA input (sold separately)

WARNING

NEVER install the rear display in a location that enables the driver to watch the video source while driving. This product's rear video output is for connection of a display to enable

passengers in the rear seats to watch the video source.

Installation

Precautions before installation

CAUTION

- Never install this product in places where, or in a manner that:
 - Could injure the driver or passengers if the vehicle stops suddenly.
 - May interfere with the driver's operation of the vehicle, such as on the floor in front of the driver's seat, or close to the steering wheel or shift lever.
- To ensure proper installation, be sure to use the supplied parts in the manner specified. If any parts are not supplied with this product, use compatible parts in the manner specified after you have the part compatibility checked by your dealer. If parts other than supplied or compatible ones are used, they may damage internal parts of this product or they may work loose and the product may become detached.
- It is extremely dangerous to allow cables to become wound around the steering column or shift lever. Be sure to install this product, its cables, and wiring away in such so that they will not obstruct or hinder driving.
- Make sure that leads cannot get caught in a door or the sliding mechanism of a seat, resulting in a short circuit.
- Please confirm the proper function of your vehicle's other equipment after installation of this product.
- Do not install this product where it may
 - (i) obstruct the driver's vision,
 - (ii) impair the performance of any of the vehicle's operating systems or safety

features, including airbags, hazard lamp buttons or
(iii) impair the driver's ability to safely operate the vehicle.

- Never install this product in front of or next to the place in the dashboard, door, or pillar from which one of your vehicle's airbags would deploy. Please refer to your vehicle's owner's manual for reference to the deployment area of the frontal airbags.

Before installing

- Consult with your nearest dealer if installation requires drilling holes or other modifications of the vehicle.
- Before making a final installation of this product, temporarily connect the wiring to confirm that the connections are correct and the system works properly.

Installation notes

- Do not install this product in places subject to high temperatures or humidity, such as:
 - Places close to a heater, vent or air conditioner.
 - Places exposed to direct sunlight, such as on top of the dashboard.
 - Places that may be exposed to rain, such as close to the door or on the vehicle's floor.
- Install this product horizontally on a surface within 0 to 30 degrees tolerance (within 5 degrees to the left or right). Improper installation of the unit with the surface tilted more than these tolerances increases the potential for errors in the

vehicle's location display, and might otherwise cause reduced display performance.



- When installing, to ensure proper heat dispersal when using this unit, make sure you leave ample space behind the rear panel and wrap any loose cables so they are not blocking the vents.

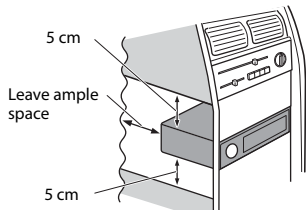

- The cords must not cover up the area shown in the figure below. This is necessary to allow the amplifiers to radiate freely. (DMH-WC6600NEX)

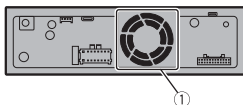

① Do not cover this area

Installation using the screw holes on the side of this product

▶DMH-WT8600NEX/DMH-WT7600NEX

Installation tips

The following procedure describes how to install this product with an LCD screen attached to the unit. Depending on the

vehicle or installation location, you may need to adjust the mounting position of the LCD screen in order to prevent impairment of vehicle driving operations. For details on the mounting LCD screen dimensions, refer to The adjusting position and mounting dimension of the display (page 12) before installing.

⚠ WARNING

Do not use a mounting sleeve to install this unit to prevent it from popping out or rattling.

- Adjust the front-back position of the front panel by removing the flush surface screws on the front edge of the unit (Ⓒ) then fix the face panel by using the screw (Ⓓ) (optional). Depending on the vehicle, the front-back position of the front panel may need to be adjusted to mount the LCD screen. Slide the face panel to the front before installing the unit to the vehicle.

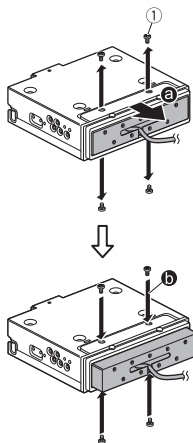

① Screw

- Fasten this product to the factory radio-mounting bracket.

Position this product so that its screw holes of the bracket, and tighten the screws at three locations on each side.

TIP

The amount of this unit's protrusion from the dashboard/console can be adjusted by shifting the position of the screw hole of this unit to the factory radio-mounting bracket.

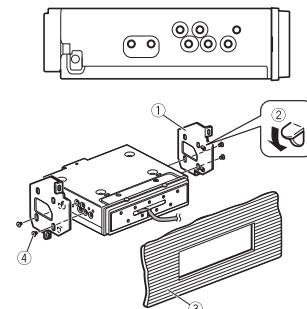

- Factory radio-mounting bracket
- If the pawl interferes with installation, you may bend it down out of the way.
- Dashboard or console
- Binding head screw (8 mm) or flush surface screw
Be sure to use the screws supplied with this product.

- Fasten the LCD screen mounting bracket to the main unit at the suitable position.

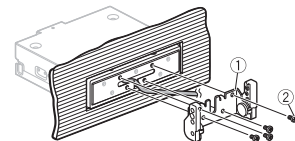

- LCD screen mounting bracket
- Binding head screw (4 mm x 6 mm)

TIP

The mounting left-center-right position of the LCD screen mounting bracket can be changed depending on the vehicle or installation location of the main unit.

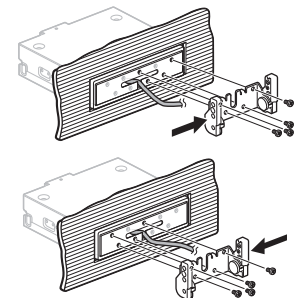

- Detach the monitor cable cover from the LCD screen (Ⓒ), then connect the monitor cable to the LCD screen (Ⓓ). After that, attach the LCD screen with adjusting the up-down position (Ⓔ) to this unit by using the screws each side (Ⓔ).

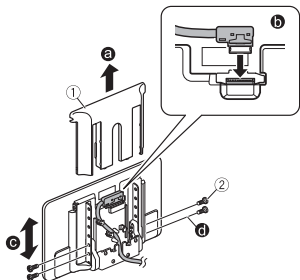

- ① Monitor cover
- ② Binding head screw (4 mm × 12 mm)

5 Secure the monitor cable to the hook on the back of the LCD screen then attach the monitor cover (a) by using the screws (b).

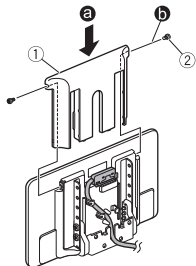

- ① Monitor cover
- ② Machine screw (2 mm × 4 mm)

►DMH-WC6600NEX

Installation tips

The following procedure describes how to use the supplied parts to install this product with the LCD screen attached to the unit. It is also possible to install this product so that the LCD screen is separate

from the unit. For details, visit the Pioneer website for your region.

For some types of vehicles, it is necessary to use an installation kit (sold separately) when installing. For details, visit the Pioneer website for your region.

1 First attach the supplied side brackets to the LCD screen (a), then attach them to this unit (b). After that, connect the monitor cable to the LCD screen (c).

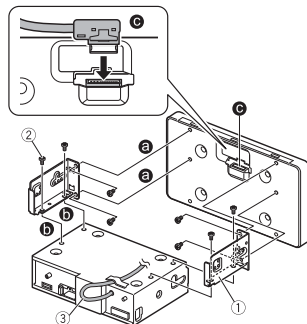

- ① Side bracket (for attaching LCD screen to unit)
- ② Binding head screw (5 mm)
Be sure to use the screws supplied with this product.
- ③ Monitor cable
Attach the monitor cable to the unit with heat resistant tape (sold separately).

2 Fasten this product to the factory radio-mounting bracket. Position this product so that its screw holes are aligned with the screw holes of the bracket, and tighten the screws at three locations on each side.

Use either the binding head screws or flush surface screws, depending on the shape of the bracket's screw holes.

TIP

The amount of this unit's protrusion from the dashboard/console can be adjusted by shifting the position of the screw hole of this unit to the factory radio-mounting bracket.

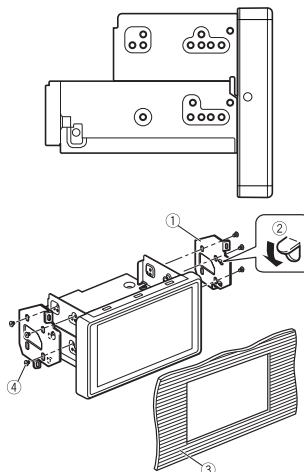

- ① Factory radio-mounting bracket
- ② If the pawl interferes with installation, you may bend it down out of the way.
- ③ Dashboard or console
- ④ Binding head screw (8 mm) or flush surface screw
Be sure to use the screws supplied with this product.

►DMH-W4600NEX/DMH-W4600NEX

1 Fasten this product to the factory radio-mounting bracket.

Position this product so that its screw holes are aligned with the screw holes of the bracket, and tighten the screws at three locations on each side.

Use either the truss head screws (5 mm × 9 mm) or flush surface screws (5 mm × 9 mm), depending on the shape of the bracket's screw holes.

TIP

The amount of this unit's protrusion from the dashboard/console can be adjusted by shifting the position of the screw hole of this unit to the factory radio-mounting bracket.

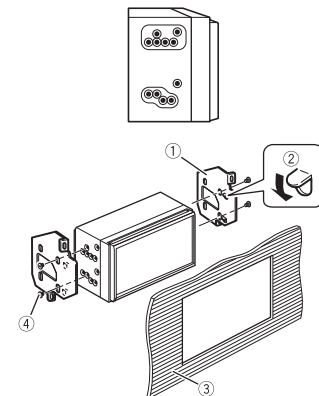

- ① Factory radio-mounting bracket
- ② If the pawl interferes with installation, you may bend it down out of the way.
- ③ Dashboard or console

- ④ Truss head screw or flush surface screw
Be sure to use the screws supplied with this product.

Installing the GPS antenna

⚠ CAUTION

Do not cut the GPS antenna lead to shorten it or use an extension to make it longer. Altering the antenna cable could result in a short circuit or malfunction and permanent damage to this product.

Installation notes

- The antenna should be installed on a level surface where radio waves will be blocked as little as possible. Radio waves cannot be received by the antenna if reception from the satellite is blocked.

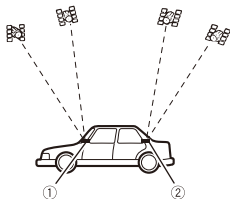

- ① Dashboard
- ② Rear shelf

- When installing the GPS antenna inside the vehicle, be sure to use the metal sheet provided with your system. If this is not used, the reception sensitivity will be poor.
- Do not cut the accessory metal sheet. This would reduce the sensitivity of the GPS antenna.

- Take care not to pull the antenna lead when removing the GPS antenna. The lead may become detached.
- Do not paint the GPS antenna, as this may affect its performance.

When installing the antenna inside the vehicle (on the dashboard or rear shelf)

⚠ WARNING

Do not install the GPS antenna over any sensors or vents on the dashboard of the vehicle, as doing so may interfere with the proper functioning of such sensors or vents and may compromise the ability of the metal sheet under the GPS antenna to properly and securely affix to the dashboard.

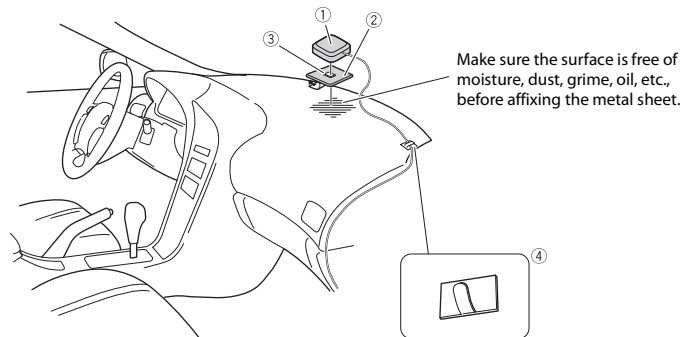

- ① GPS antenna
- ② Metal sheet
Peel off the protective sheet on the rear.
- ③ Double-sided tape
- ④ Clamps

Use clamps to secure the lead where necessary inside the vehicle.

NOTES

- Affix the metal sheet on the surface as level as possible where the GPS antenna faces the window.
- Affix the GPS antenna on the metal sheet using the double-sided tape.
- The metal sheet contains a strong adhesive which may leave a mark on the surface if it is removed.
- When attaching the metal sheet, do not cut it into small pieces.
- Some models use window glass that does not allow signals from GPS satellites to pass through. On such models, install the GPS antenna on the outside of the vehicle.

Installing the microphone

- Install the microphone in a place where its direction and distance from the driver make it easiest to pick up the driver's voice.
- Be sure to turn off (ACC OFF) the product before connecting the microphone.
- Depending on the vehicle model, the microphone cable length may be too short when you mount the microphone on the sun visor. In such cases, install the microphone on the steering column.

Mounting on the sun visor

- 1 Fit the microphone lead into the groove.

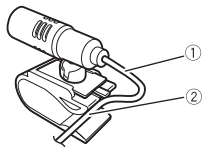

- ① Microphone lead
- ② Groove

- 2 Attach the microphone clip to the sun visor.

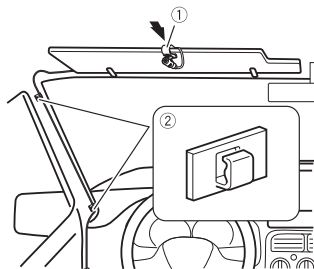

- ① Microphone clip
- ② Clamps

Use separately sold clamps to secure the lead where necessary inside the vehicle.

Install the microphone on the sun visor when it is in the up position. It cannot recognize the driver's voice if the sun visor is in the down position.

Installation on the steering column

- 1 Detach the microphone base from the microphone clip by sliding the microphone base while pressing the tab.

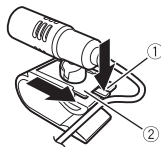

- ① Tab
- ② Microphone base

- 2 Mount the microphone on the steering column.

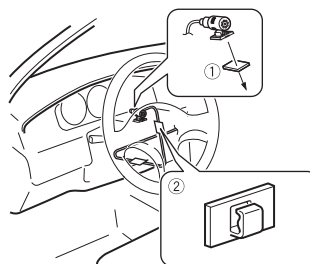

- ① Double-sided tape
- ② Clamps

Use separately sold clamps to secure the lead where necessary inside the vehicle.

NOTE

Install the microphone on the steering column, keeping it away from the steering wheel.

Adjusting the microphone angle

The microphone angle can be adjusted.



The adjusting position and mounting dimension of the display

► DMH-WT8600NEX/DMH-WT7600NEX

The mounting position of this unit's display can be adjusted (front-back/up-down/right-left/angle). When mounting the display, adjust the mounting position and dimensions so that your view is clear and it does not impair your driving.

⚠ WARNING

Make sure that none of the following conditions exist when mounting the display. Otherwise, an accident may occur.

- It impairs the operation of the steering wheel and levers (shift lever, windshield wiper switch, turn signal switch, etc.).
- It impairs the operation of the airbags.
- It significantly impairs the operation of the hazard switch.
- It impairs the ability to identify or operate other control switches.
- You are unable to see gauges, meters or warning indicators.
- It interferes with in-vehicle devices (switches, panel, glove compartment, cup holder, etc.).

Depending on the vehicle, the display may hinder access to the glove compartment or cup holder, or it may block the air conditioner vents.

**Display mounting dimensions
and adjustable positions**

► Front-back position

Front

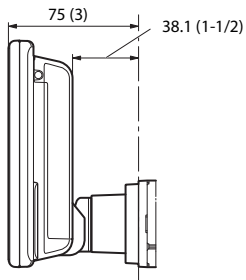

mm (in.)

Back

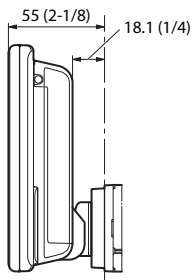

mm (in.)

► Left-right position

DMH-WT8600NEX

Center

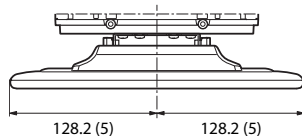

mm (in.)

Left

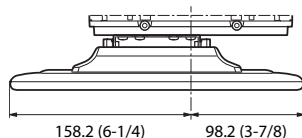

mm (in.)

Right

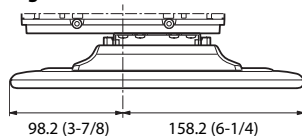

mm (in.)

DMH-WT7600NEX

Center

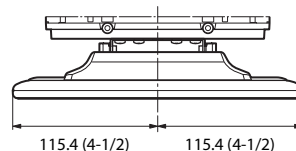

mm (in.)

Left

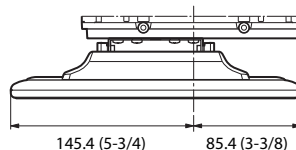

mm (in.)

Right

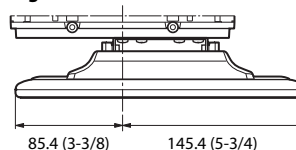

mm (in.)

Adjustable display angles and up-down positions

⚠ WARNING

Keep hands and fingers clear of this product when adjusting the LCD screen angle. Be especially cautious of children's hands and fingers.

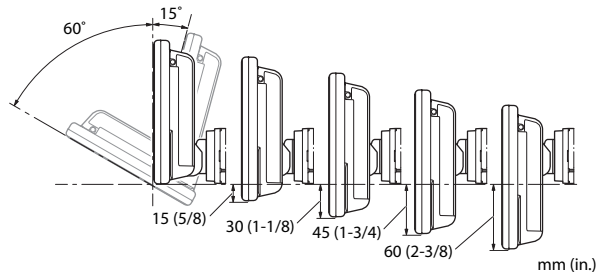

NOTE

Certain positions cannot be adjusted and held depending on the up-down position and the front-back position. For details, refer to Mounting dimension with the angle range of the display (page 14).

Mounting dimension with the angle range of the display

► Front angle range

Angle range of front position		
	A	B
0	60°	-15°
-15 (-5/8)	35°	
-30 (-1-1/8)		
-45 (-1-3/4)		
-60 (-2-3/8)		

mm (in.)

DMH-WT8600NEX

	Angle 60°					Angle 35°					Angle -15°				
	A	A'	B	B'	C	A	A'	B	B'	C	A	A'	B	B'	C
0	58.3 (2-1/4)	166.1 (6-1/2)	-14.8 (-1/2)	39.4 (1-1/2)	33.4 (1-1/4)	107.3 (4-1/4)	137.3 (5-3/8)	-12.5 (-1/2)	53.4 (2-1/8)	35.9 (1-3/8)	149.0 (5-7/8)	34.6 (1-3/8)	7.7 (1/4)	72.4 (2-7/8)	14.3 (1/2)
-15 (-5/8)						95.0 (3-3/4)	128.7 (5)	-24.8 (-1)	44.8 (1-3/4)	27.3 (1)	134.6 (5-1/4)	38.4 (1-1/2)	-6.8 (-1/4)	76.3 (3)	18.2 (3/4)
-30 (-1-1/8)						82.7 (3-1/4)	120.1 (4-3/4)	-37.1 (-1-1/2)	36.2 (1-3/8)	18.7 (3/4)	120.1 (4-3/4)	42.3 (1-5/8)	-21.2 (-7/8)	80.2 (3-1/8)	22.1 (7/8)
-45 (-1-3/4)						70.5 (2-3/4)	111.5 (4-8/3)	-49.4 (-1-7/8)	27.6 (1)	10.1 (3/8)	105.6 (4-1/8)	46.2 (1-3/4)	-35.7 (-1-3/8)	84.1 (3-1/4)	26.0 (1)
-60 (-2-3/8)						58.2 (2-1/4)	102.9 (4)	-61.7 (-2-3/8)	19.0 (3/4)	1.5 (1/8)	91.1 (3-5/8)	50.1 (2)	-50.2 (-2)	88.0 (3-1/2)	29.9 (1-1/8)

mm (in.)

DMH-WT7600NEX

	Angle 60°					Angle 35°					Angle -15°				
	A	A'	B	B'	C	A	A'	B	B'	C	A	A'	B	B'	C
0	50.6 (2)	152.6 (6)	-14.8 (-1/2)	39.4 (1-1/2)	33.4 (1-1/4)	94.6 (3-3/4)	128.4 (5)	-12.5 (-1/2)	53.4 (2-1/8)	35.9 (1-3/8)	134.1 (5-1/4)	38.6 (1-1/2)	7.7 (1/4)	72.4 (2-7/8)	14.3 (1/2)
-15 (-5/8)						82.3 (3-1/4)	119.8 (4-5/8)	-24.8 (-1)	44.8 (1-3/4)	27.3 (1)	119.6 (4-5/8)	42.5 (1-5/8)	-6.8 (-1/4)	76.3 (3)	18.2 (3/4)
-30 (-1-1/8)						70.1 (2-3/4)	111.2 (4-3/8)	-37.1 (-1-1/2)	36.2 (1-3/8)	18.7 (3/4)	105.1 (4-1/8)	46.3 (1-3/4)	-21.2 (-7/8)	80.2 (3-1/8)	22.1 (7/8)
-45 (-1-3/4)						57.8 (2-1/4)	102.6 (4)	-49.4 (-1-7/8)	27.6 (1)	10.1 (3/8)	90.6 (3-1/2)	50.2 (2)	-35.7 (-1-3/8)	84.1 (3-1/4)	26.0 (1)
-60 (-2-3/8)						45.5 (1-3/4)	94.0 (3-3/4)	-61.7 (-2-3/8)	19.0 (3/4)	1.5 (1/8)	76.1 (3)	54.1 (2-1/8)	-50.2 (-2)	88.0 (3-1/2)	29.9 (1-1/8)

mm (in.)

► Back angle range

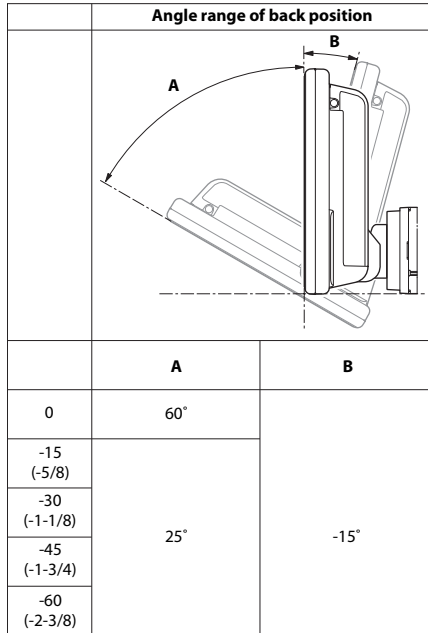

mm (in.)

DMH-WT8600NEX

	Angle 60°					Angle 25°					Angle -15°				
	A	A'	B	B'	C	A	A'	B	B'	C	A	A'	B	B'	C
0	58.3 (2-1/4)	146.1 (5-3/4)	-14.8 (-1/2)	19.4 (3/4)	13.4 (1/2)	122.7 (4-3/4)	100.3 (3-7/8)	-9.9 (-3/8)	38.5 (1-1/2)	16.7 (5/8)	149.0 (5-7/8)	14.6 (1/2)	7.7 (1/4)	52.4 (2)	-5.7 (-1/4)
-15 (-5/8)						109.1 (4-1/4)	94.0 (3-3/4)	-23.5 (-7/8)	32.2 (1-1/4)	10.4 (3/8)	134.6 (5-1/4)	18.4 (3/4)	-6.8 (-1/4)	56.3 (2-1/4)	-1.8 (-1/8)
-30 (-1-1/8)						95.5 (3-3/4)	87.7 (3-3/8)	-37.1 (-1-1/2)	25.8 (1)	4.1 (1/4)	120.1 (4-3/4)	22.3 (7/8)	-21.2 (-7/8)	60.2 (2-3/8)	2.1 (1/8)
-45 (-1-3/4)						81.9 (3-1/4)	81.3 (3-1/4)	-50.7 (-2)	19.5 (3/4)	-2.3 (-1/8)	105.6 (4-1/8)	26.2 (1)	-35.7 (-1-3/8)	64.1 (2-1/2)	6.0 (1/4)
-60 (-2-3/8)						68.3 (2-5/8)	75.0 (3)	-64.3 (-2-1/2)	13.2 (1/2)	-8.6 (-3/8)	91.1 (3-5/8)	30.1 (1-1/8)	-50.2 (-2)	68.0 (2-5/8)	9.9 (3/8)

mm (in.)

DMH-WT7600NEX

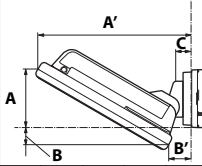
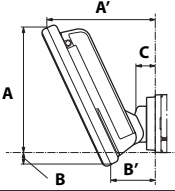
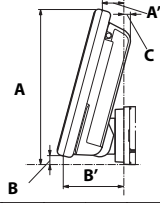
	Angle 60°					Angle 25°					Angle -15°				
															
	A	A'	B	B'	C	A	A'	B	B'	C	A	A'	B	B'	C
0	50.6 (2)	132.6 (5-1/4)	-14.8 (-1/2)	19.4 (3/4)	13.4 (1/2)	108.6 (4-1/4)	93.8 (3-5/8)	-9.9 (-3/8)	38.5 (1-1/2)	16.7 (5/8)	134.1 (5-1/4)	18.6 (3/4)	7.7 (1/4)	52.4 (2)	-5.7 (-1/4)
-15 (-5/8)						95.0 (3-3/4)	87.5 (3-3/8)	-23.5 (-7/8)	32.2 (1-1/4)	10.4 (3/8)	119.6 (4-5/8)	22.5 (7/8)	-6.8 (-1/4)	56.3 (2-1/4)	-1.8 (-1/8)
-30 (-1-1/8)						81.4 (3-1/4)	81.1 (3-1/4)	-37.1 (-1-1/2)	25.8 (1)	4.1 (1/4)	105.1 (4-1/8)	26.3 (1)	-21.2 (-7/8)	60.2 (2-3/8)	2.1 (1/8)
-45 (-1-3/4)						67.8 (2-5/8)	74.8 (2-7/8)	-50.7 (-2)	19.5 (3/4)	-2.3 (-1/8)	90.6 (3-1/2)	30.2 (1-1/8)	-35.7 (-1-3/8)	64.1 (2-1/2)	6.0 (1/4)
-60 (-2-3/8)						54.2 (2-1/8)	68.4 (2-5/8)	-64.3 (-2-1/2)	13.2 (1/2)	-8.6 (-3/8)	76.1 (3)	34.1 (1-3/8)	-50.2 (-2)	68.0 (2-5/8)	9.9 (3/8)

mm (in.)

NOTES

- Where there are no numbers in the table, this indicates that the display cannot be adjusted and held with that angle and dimensions.
- The displayed angle range is the movable range of this unit, and it may vary depending on the vehicle in which the unit is installed.

PIONEER CORPORATION

28-8, Honkomagome 2-chome, Bunkyo-ku,
Tokyo 113-0021, Japan

PIONEER ELECTRONICS (USA) INC.

P.O. Box 1540, Long Beach, California 90801-1540, U.S.A.
TEL: (800) 421-1404

PIONEER EUROPE NV

Haven 1087, Keetberglaan 1, B-9120 Melsele, Belgium/Belgique
TEL: (0) 3/570.05.11

PIONEER ELECTRONICS ASIACENTRE PTE. LTD.

2 Jalan Kilang Barat, #07-01, Singapore 159346
TEL: 65-6378-7888

PIONEER ELECTRONICS AUSTRALIA PTY. LTD.

5 Arco Lane, Heatherton, Victoria, 3202 Australia
TEL: (03) 9586-6300

PIONEER ELECTRONICS DE MÉXICO S.A. DE C.V.

Blvd. Manuel Ávila Camacho 138, 10 piso
Col.Lomas de Chapultepec, México, D.F. 11000
Tel: 52-55-9178-4270, Fax: 52-55-5202-3714

先鋒股份有限公司

台北市內湖區瑞光路407號8樓
電話：886-(0)2-2657-3588

先鋒電子（香港）有限公司

香港九龍長沙灣道909號5樓
電話：852-2848-6488

RDS AV RECEIVER
RÉCEPTEUR AV RDS
RECEPTOR AV RDS

DMH-WT8600NEX
DMH-WT7600NEX
DMH-WC6600NEX
DMH-W4660NEX
DMH-W4600NEX

Pioneer

Quick start guide
Guide de démarrage rapide
Guía de inicio rápido

English

This guide is intended to guide you through the basic functions of this unit.
For details, please refer to the Operation manual stored on the website.

<https://www.pioneerelectronics.com/PUSA/Car>



Français

Ce guide est destiné à vous guider dans les fonctions de base de cet appareil.
Pour les détails, veuillez vous reporter au Mode d'emploi disponible sur le site Web.

<https://www.pioneerelectronics.com/PUSA/Car>



Español

Esta guía tiene como fin explicar las funciones básicas de esta unidad.
Para obtener más información, consulte el manual de operaciones que se encuentra en el sitio web.

<https://www.pioneerelectronics.com/PUSA/Car>



English

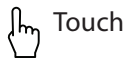

Touch



Touch and hold

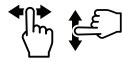

Swipe

What's What

►DMH-WT8600NEX/DMH-WT7600NEX/DMH-WC6600NEX



►DMH-W4660NEX/DMH-W4600NEX

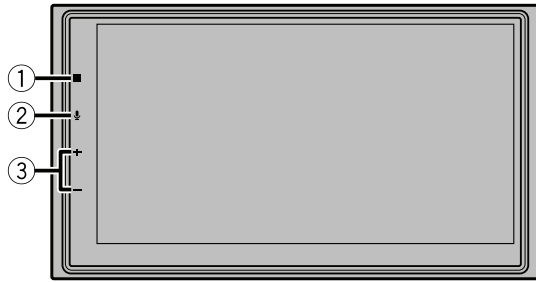

①		Display the top menu screen Power off
②		Activate the voice recognition mode Display mobile device search or select screen
③		Volume

Starting up the unit

1 language → → [Standard Mode] or [Network Mode]

⚠ WARNING

Do not use the unit in Standard Mode when a speaker system for 3-way Network Mode is connected to the unit. This may cause damage to the speakers.

2 [OK] → [OK]

Wi-Fi connection

⚠ WARNING

- Do not attempt to operate the web browser while driving. Make sure to pull off the road and park your vehicle in a safe location before attempting to use the controls on the web browser.
- When you use the browser, do not enter your important information such as credit card information, bank account information and personal information.
- When you use the browser, do not install the software or program that Pioneer is not involved with. If you install such software or program, you may suffer from damages such as mechanical trouble or put your entered information in danger.

1 → screen

2 → → [Wi-Fi Settings] → [Access point setting] →

Bluetooth® connection

1 → screen

2 → → [Connection] →

CarAVAssist

Using CarAVAssist anytime, anywhere, optimize and expand your in-car and daily life.

NOTE

CarAVAssist must be connected to this unit in order to synchronize the changes.



Download Now



CarAVAssist is an application that allows you to configure and transfer various settings of this unit and register URLs as favorites so that you can browse them using this unit's web browser.

Selecting the source/application



①

← Display the source/application selection screen and select a source/application



①

→ Display the source/application list and select a source/application

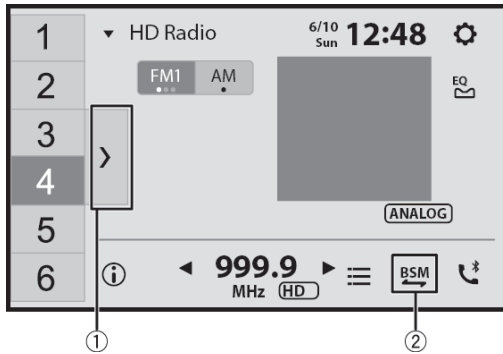

Tuner operation

- 1   screen
- 2  [HD Radio] or [Radio]





①	 Display the preset channel list
②	 Store the strongest broadcast frequencies

Audio operation

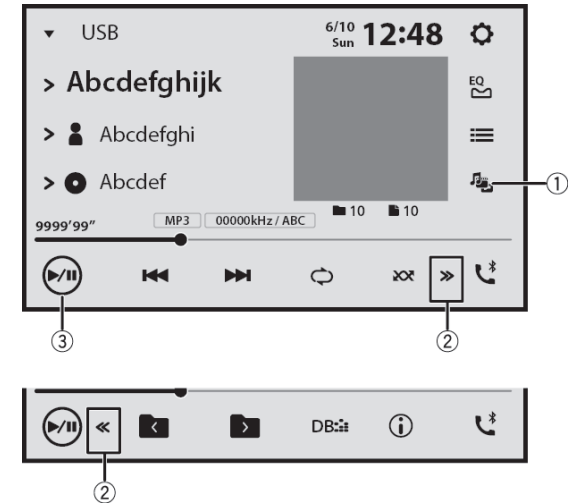
- 1   screen
- 2  audio source



①	 Switch between media file types
②	 Display the hidden function bar
③	 Pause and start playback

Video operation

- 1 → screen
- 2 video source

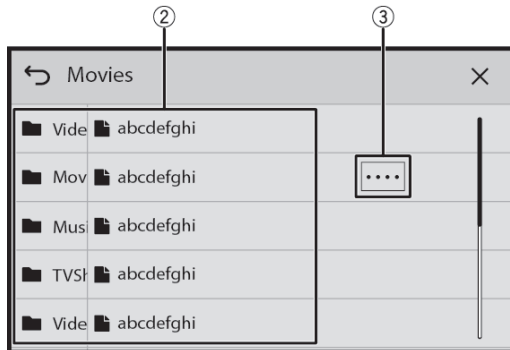

- | | |
|---|--|
| ① | Display the playlist screen |
| ② | Select a list title that you want to play |
| ③ | Scroll the list title or category name |

Bluetooth telephone operation

- 1 → screen
- 2

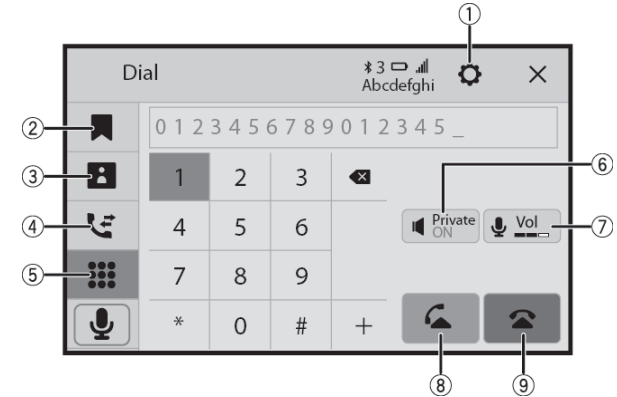

- | | |
|---|--|
| ① | Display the Bluetooth connection menu |
| ② | Display the preset dial screen |
| ③ | Switch to the phone book mode |
| ④ | Switch to the call history list |
| ⑤ | Enter the phone number directly |
| ⑥ | Turn private mode on and off |
| ⑦ | Adjust the talking volume |
| ⑧ | Make an outgoing call |
| ⑨ | End a call |

Pioneer DMH-WT8600NEX

Monitor size:

10-1/8 inches (width) x 5-3/4 inches (height) x 1-1/2 inches (depth)
257mm (width) x 147mm (height) x 37mm (depth)

PRINTING INSTRUCTIONS (use of the latest version of Adobe® Acrobat® Reader® or Acrobat Pro software is recommended)

This image represents actual product size when printed in Actual size on US letter size paper.

1. Choose File > Print.
2. Within the **Paper Sizing & Handling** section, choose **Actual size**.
3. In the Document preview pane, confirm the Document size is 11.0 x 8.5in.
4. Click the **Print** button.
5. To check printing size accuracy, use a ruler or measuring tape. The outside dimensions of this image should match the measurements shown above.
6. Cut out this image to use as a template to check the size of the DMH-WT8600NEX monitor in your vehicle.

Read the important display mounting **⚠ WARNING** on page 12 of the **Installation Manual**.

The DMH-WT8600NEX monitor can be configured in multiple horizontal, vertical and angled positions. See pages 12 - 17 of the **Installation Manual** for details. pioneerelectronics.com/PUSA/Car/NEX/DMH-WT8600NEX#manuals

Ensure that the monitor will not obstruct the driver's clear view of the road, impair the performance of any of the vehicle's operating system or safety features including airbags, indicators (lights) and hazard lamp buttons, or impair the driver's ability to safely operate the vehicle.

Pioneer





ABOUT ALEXA BUILT-IN

- This unit is currently compatible only with English (US) speech recognition and Amazon Music, Kindle, Audible and Pandora® services operating with Alexa Built-in for automotive devices. Additional language support and services will be available in the future.
- Downloading Pioneer's CarAVAssist app will enable automatic notifications to stay up-to-date on the newest features and product updates, including additional language support and compatible services. Download the CarAVAssist app on the App Store® for iOS devices and Google Play™ for Android™ devices, or visit our website at www.PioneerElectronics.com for information on updates.

Amazon, Alexa, Amazon Music, Kindle and Audible are trademarks of Amazon.com, Inc. or its affiliates.

Pandora is a registered trademark of Pandora Media, LLC.

App Store is a registered trademark of Apple Inc.

Google Play and Android are trademarks of Google LLC.

DMH Alexa - 4/2020



PIONEER ELECTRONICS (USA) INC.
LIMITED WARRANTY

WARRANTY VALID ONLY IN COUNTRY OF PRODUCT PURCHASE

WARRANTY

Pioneer Electronics (USA) Inc. (Pioneer) warrants that Pioneer® Car Electronics, Speaker, and Accessory Products distributed by Pioneer in the U.S.A. and Canada that fail to function properly under normal use due to a manufacturing defect when installed and operated according to the owner's manual enclosed with the unit will be repaired or replaced with a unit of comparable value, at Pioneer's option, without charge to you for parts or actual repair work. Replacement units and/or parts supplied under this warranty may be new or rebuilt at Pioneer's option.

This Limited Warranty applies to the original or any subsequent owner of this Pioneer product during the warranty period provided the product was purchased from an authorized Pioneer dealer in the U.S.A. or Canada. You will be required to provide a sales receipt or other valid proof of purchase showing the date of original purchase. In the event service is required, the product must be delivered within the warranty period, transportation prepaid, only from within the country of purchase as explained in this document. You will be responsible for removal and installation of the product. Pioneer will pay to return the repaired or replacement product to you within the country of purchase.

PRODUCT WARRANTY PERIOD (Runs from the date of first retail sale)

	<u>Parts</u>	<u>Labor</u>
Car Electronics, Speakers, and Accessories	1 Year	1 Year

WHAT IS NOT COVERED

This Limited Warranty applies to Pioneer products that are purchased from an authorized Pioneer dealer. IF THIS PRODUCT WAS PURCHASED FROM ANY OTHER SOURCE, THERE ARE NO WARRANTIES, EXPRESS OR IMPLIED, INCLUDING THE IMPLIED WARRANTY OF MERCHANTABILITY AND THE IMPLIED WARRANTY OF FITNESS FOR A PARTICULAR PURPOSE AND THIS PRODUCT IS SOLD STRICTLY "AS IS" AND "WITH ALL FAULTS". PIONEER SHALL NOT BE LIABLE FOR ANY CONSEQUENTIAL AND/OR INCIDENTAL DAMAGES. Some states and provinces do not allow the exclusion or limitation of incidental or consequential damages, so the above limitation or exclusion may not apply to you.

Pioneer does not warrant any product listed above when it is used in a trade or business or in any industrial or commercial application. This warranty does not apply if the product has been subjected to power in excess of its published power rating. This warranty does not cover cosmetic scratches or any other appearance item; damage or defects resulting from alterations or modifications not authorized in writing by Pioneer; accident, collisions, misuse or abuse; the use of unauthorized parts or labor; improper installation or maintenance; lightning or power surges; subsequent damage from leaking; damage from inoperative batteries; or the use of batteries not conforming to those specified in the owner's manual. This warranty does not cover the cost of parts or labor that would otherwise be provided without charge under this warranty obtained from any source other than Pioneer. Altered, defaced, or removed serial numbers void this warranty.

NO OTHER WARRANTIES

TO THE FULLEST EXTENT PERMITTED BY LAW, PIONEER MAKES NO REPRESENTATIONS OR WARRANTIES OR ACCEPTS ANY CONDITIONS WITH RESPECT TO THIS PRODUCT EXCEPT AS STATED IN THIS DOCUMENT. PIONEER LIMITS ITS OBLIGATIONS UNDER ANY IMPLIED WARRANTIES AND CONDITIONS INCLUDING, BUT NOT LIMITED TO, WARRANTIES AND CONDITIONS, WHETHER EXPRESS OR IMPLIED, OF MERCHANTABILITY AND FITNESS FOR A PARTICULAR PURPOSE, TO A PERIOD NOT TO EXCEED THE WARRANTY PERIOD. NO WARRANTIES OR CONDITIONS SHALL APPLY AFTER THE WARRANTY PERIOD. Some states and provinces do not allow limitations on how long an implied warranty lasts, so the above limitations or exclusions may not apply to you.

This warranty gives you specific legal rights, and you may also have other rights which vary from state to state or province to province. To the extent any provision of this limited warranty is deemed invalid or unenforceable under applicable law, such determination will have no effect on the remaining provisions, which will continue in full force and effect.

TO OBTAIN SERVICE

In the U.S.A. or Canada, to receive warranty service, you need to present your sales receipt showing place and date of original owner's transaction.

Please contact one of the following to obtain service:

Your Authorized Pioneer Dealer - Your Pioneer Dealer may repair or replace your unit or refer you to an Authorized Pioneer Service Company. Your sales receipt should list the contact information (phone number, fax, email, etc.) for your Dealer.

Pioneer Customer Support - Can advise the optimal service option for your model and geographic location. Please call us at **1-800-421-1404** or visit www.pioneerelectronics.com (for USA) or <http://www.pioneerelectronics.ca> (for Canada), click on "Support," then select "Contact Us."

Your Authorized Pioneer Service Company - Can perform repairs for most Car Electronics, Speaker and Accessory products and advise other options as applicable. Please visit Pioneer's website, click on "Support," and select "Find a Service Center."

Shipping Your Unit for Service - YOU MUST FIRST CONTACT PIONEER TO GET RETURN AUTHORIZATION. PLEASE DO NOT SEND IN YOUR PRODUCT WITHOUT CONTACTING CUSTOMER SUPPORT. If you have a return authorization number, please package the product carefully and send it transportation prepaid by a traceable, insured method to an Authorized Pioneer Service Company or Pioneer. Use adequate padding material to prevent damage in transit. Include your name, address and a telephone number where you can be reached during business hours.

For questions about your product, please contact Pioneer Customer Support as described above or write to us at:

Customer Support
Pioneer Electronics (USA) Inc.
P.O. Box 1720
Long Beach, California 90801 U.S.A.

DISPUTE RESOLUTION

Following our response to any initial request to Customer Support, should a dispute arise between you and Pioneer, Pioneer makes available its Complaint Resolution Program to resolve the dispute. The Complaint Resolution Program is available to you without charge. In the U.S.A., you are required to use the Complaint Resolution Program before you exercise any rights under, or seek any remedies, created by the Magnuson-Moss Warranty Act but may be entitled to file suit under state law without using the Complaint Resolution Program. To use the Complaint Resolution Program, call 1-800-421-1404 and explain to the customer service representative the problem you are experiencing, steps you have taken to have the product repaired during the warranty period, and the name of the authorized Pioneer Dealer from which the Pioneer product was purchased. After the complaint has been explained to the representative, a resolution number will be issued. Within forty (40) days of receiving your complaint, Pioneer will investigate the dispute and will either: (1) respond to your complaint in writing informing you what action Pioneer will take, and in what time period, to resolve the dispute; or (2) respond to your complaint in writing informing you why Pioneer will not take any action.

RECORD THE PLACE AND DATE OF PURCHASE. KEEP THIS INFORMATION AND YOUR SALES RECEIPT IN A SAFE PLACE

Model No. _____ Serial No. _____ Purchase Date _____

Purchased From _____