

Pioneer

Owner's Manual
Mode d'emploi

BRIDGEABLE FOUR-CHANNEL POWER AMPLIFIER
AMPLIFICATEUR DE PUISSANCE PONTABLE À QUATRE CANAUX

GM-A6704
GM-A4704

English
Français

Before you start

Thank you for purchasing this PIONEER product

To ensure proper use, please read through this manual before using this product. It is especially important that you read and observe **WARNINGs** and **CAUTIONs** in this manual. *Please keep the manual in a safe and accessible place for future reference.*



This device complies with Part 15 of the FCC Rules. Operation is subject to the following two conditions:
(1) This device may not cause harmful interference, and (2) this device must accept any interference received, including interference that may cause undesired operation.

Information to User

Alteration or modifications carried out without appropriate authorization may invalidate the user's right to operate the equipment.

Note

This equipment has been tested and found to comply with the limits for a Class B digital device, pursuant to Part 15 of the FCC Rules. These limits are designed to provide reasonable protection against harmful interference in a residential installation. This equipment generates, uses and can radiate radio frequency energy and, if not installed and used in accordance with the instructions, may cause harmful interference to radio communications. However, there is no guarantee that interference will not occur in a particular installation. If this equipment does cause harmful interference to radio or television reception, which can be determined by turning the equipment off and on, the user is encouraged to try to correct the interference by one or more of the fol-

lowing measures:

- Reorient or relocate the receiving antenna.
- Increase the separation between the equipment and receiver.
- Connect the equipment into an outlet on a circuit different from that to which the receiver is connected.
- Consult the dealer or an experienced radio/TV technician for help. 

Before you start

After-sales service for Pioneer products

Please contact the dealer or distributor from where you purchased this unit for after-sales service (including warranty conditions) or any other information. In case the necessary information is not available, please contact the companies listed below:

Please do not ship your unit to the companies at the addresses listed below for repair without advance contact.

USA&CANADA

Pioneer Electronics (USA) Inc.
CUSTOMER SUPPORT DIVISION
P.O. Box 1760
Long Beach, CA 90801-1760
800-421-1404

For warranty information please see the Limited Warranty sheet included with this unit.

If you experience problems

Should this product fail to operate properly, please contact your dealer or nearest authorized Pioneer Service Station.

Visit our website

<http://www.pioneerelectronics.com>

in Canada

<http://www.pioneerelectronics.ca>

- Learn about product updates (such as firmware updates) for your product.
- Register your product to receive notices about product updates and to safeguard purchase details in our files in the event of loss or theft.
- Access owner's manuals, spare parts information, service information, and much more.

The Safety of Your Ears is in Your Hands

Get the most out of your equipment by playing it at a safe level—a level that lets the sound come through clearly without annoying blaring or distortion and, most importantly, without affecting your sensitive hearing. Sound can be deceiving. Over time, your hearing “comfort level” adapts to higher volumes of sound, so what sounds “normal” can actually be loud and harmful to your hearing. Guard against this by setting your equipment at a safe level BEFORE your hearing adapts.

ESTABLISH A SAFE LEVEL:

- Set your volume control at a low setting.
- Slowly increase the sound until you can hear it comfortably and clearly, without distortion.
- Once you have established a comfortable sound level, set the dial and leave it there.

BE SURE TO OBSERVE THE FOLLOWING GUIDELINES:

- Do not turn up the volume so high that you can't hear what's around you.
- Use caution or temporarily discontinue use in potentially hazardous situations.
- Do not use headphones while operating a motorized vehicle; the use of headphones may create a traffic hazard and is illegal in many areas.

Before connecting/ installing the amplifier

WARNING

- The use of a special red battery and ground wire RD-223, available separately, is recommended. Connect the battery wire directly to the car battery positive terminal ⊕ and the ground wire to the car body.
- This unit is for vehicles with a 12V battery and negative grounding. Before installing in recreational vehicles, trucks or buses, check the battery voltage.
- When installing this unit, make sure to connect the ground wire first. Ensure that the ground wire is properly connected to metal parts of the car's body. The ground wire of the one of this unit must be connected to the car separately with different screws. If the screw for the ground wire loosens or falls out, it could result in fire, generation of smoke or malfunction.
- Always use a fuse of the rating prescribed. The use of an improper fuse could result in overheating and smoke, damage to the product and injury, including burns.
- Check the connections of the power supply and speakers if the fuse of the separately sold battery wire or the amplifier fuse blows. Determine and resolve the cause, then replace the fuse with an identical equivalent.
- Always install the amplifier on a flat surface. Do not install the amplifier on a surface that is not flat or on a surface with a protrusion. Doing so could result in malfunction.
- When installing the amplifier, do not allow parts such as extra screws to get caught between the amplifier and the automobile. Doing so could cause malfunction.
- Do not allow this unit to come into contact with liquids. Electrical shock could result. Also, damage to this unit, smoke, and overheating could result from contact with liquids. The surfaces of the amplifier and any attached

speakers may also heat up and cause minor burns.

- In the event of any abnormality, the power supply to the amplifier is cut off to prevent equipment malfunction. If this occurs, switch the system power off and check the power supply and speaker connections. If you are unable to determine the cause, please contact your dealer.
- Always disconnect the negative ⊖ terminal of the battery beforehand to avoid the risk of electric shock or short circuit during installation.
- Do not attempt to disassemble or modify this unit. Doing so may result in fire, electric shock or other malfunction.

CAUTION

- Always keep the volume low enough to hear outside sounds.
- Extended use of the car stereo while the engine is at rest or idling may exhaust the battery.
- This product is evaluated in moderate and tropical climate condition under the Audio, video and similar electronic apparatus - Safety requirements, IEC 60065.
- The graphical symbol  placed on the product means direct current.

About the protection function

This product has protection function. When this product detects something abnormal, the following functions will operate to protect the product and speaker output.

- The power indicator will turn off and the amplifier will shut down in the situations outlined below.
 - If the speaker output terminal and speaker wire are short-circuited.
 - If a DC voltage is applied to the speaker output terminal.

Before you start

- The amplifier will reduce the power output if the temperature inside the amplifier gets high. If the temperature gets too high, the power indicator will turn off, and the amplifier will shut down.

🔑 Important (Serial number)

The serial number is located on the bottom of this unit. For your own security and convenience, be sure to record this number on the enclosed warranty card. ■

Setting the unit

What's what

GM-A6704

Front side

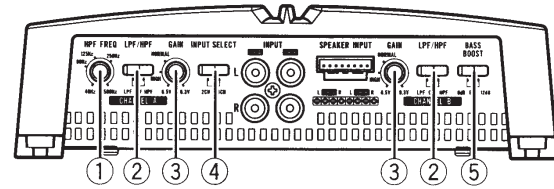

Rear side

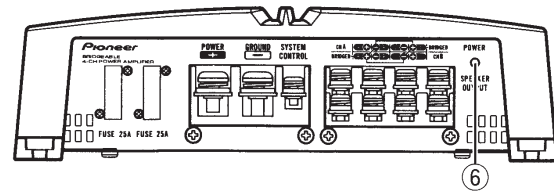

GM-A4704

Front side

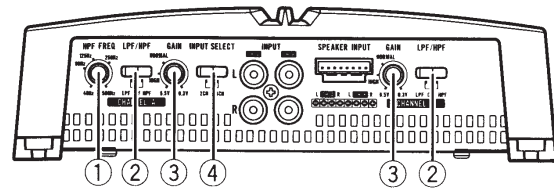

Rear side

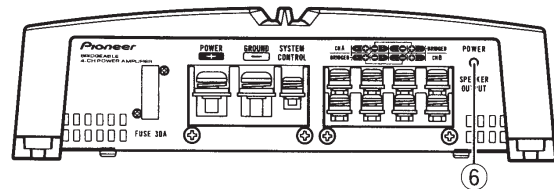

To adjust the switch, use a flathead screwdriver if needed.

- ① HPF FREQ (cut off frequency) control**
Cut off frequency selectable from 40 Hz to 500 Hz if the **HPF** select switch is set to **HPF**.
 - You can select cut off frequency only for **CHANNEL A**.
- ② LPF (low-pass filter)/HPF (high-pass filter) select switch**
Switch the settings based on the connected speaker.
 - When the Subwoofer is connected:

Setting the unit

Select **LPF**. This eliminates high range frequency and outputs low range frequency.

- When the full range speaker is connected:
Select **HPF** or **OFF**. **HPF** eliminates low range frequency and output high range frequency. **OFF** outputs the entire frequency range.

③ GAIN (gain) control

Adjusting gain controls **CHANNEL A** (channel A) and **CHANNEL B** (channel B) helps align the car stereo output to the Pioneer amplifier. Default setting is the **NORMAL** position.

If the output remains low, even when the car stereo volume is turned up, turn the controls to a lower level. If distortion occurs when the car stereo volume is turned up, turn these controls to a higher level.

- If using only one input plug, set the gain controls for speaker outputs A and B to the same position.
- For use with an RCA equipped car stereo (standard output of 500 mV), set to the **NORMAL** position. For use with an RCA equipped Pioneer car stereo, with maximum output of 4 V or more, adjust level to match that of the car stereo output.
- For use with an RCA equipped car stereo with output of 4 V, set to the **HIGH** position.

④ INPUT SELECT (input select) switch

Select **2CH** for two-channel input and **4CH** for four-channel input.

- You can select input select only for connections when using the RCA input jack. For connections when using the speaker input wire, **4CH** will be used automatically no matter which switch setting is selected.

⑤ BASS BOOST (bass boost level control) switch

You can select a bass boost level from 0 dB, 6 dB and 12 dB.

- Bass boost level setting applies only to **CHANNEL B** (channel B) output.

⑥ Power indicator

The power indicator lights up to indicate power ON. 

Setting gain properly

- Protective function included to prevent malfunction of the unit and/or speakers due to excessive output, improper use or improper connection.
- When outputting high volume sound etc., this function cuts off the output for a few seconds as a normal function, but output is restored when the volume of the head unit is turned down.
- A cut in sound output may indicate improper setting of the gain control. To ensure continuous sound output with the head unit at a high volume, set amplifier gain control to a level appropriate for the preout maximum output level of the head unit, so that volume can remain unchanged and to control excess output.
- Despite correct volume and gain settings, the unit sound still cuts out periodically. In such cases, please contact the nearest authorized Pioneer Service Station.

Gain control of this unit

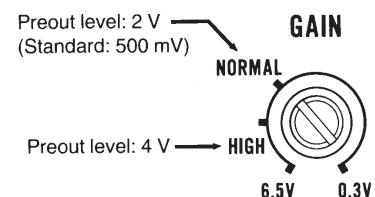

Above illustration shows **NORMAL** gain setting.

Setting the unit

Relationship between amplifier gain and head unit output power

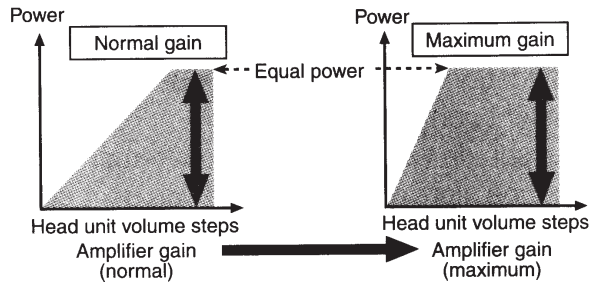

If amplifier gain is raised improperly, this will simply increase distortion, with little increase in power.

Signal waveform when outputting at high volume using amplifier gain control

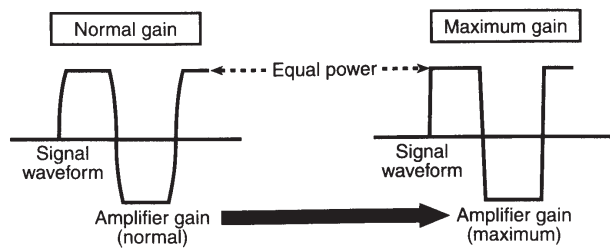

If the signal waveform is distorted due to high output, even if the amplifier gain is raised, the output power will change only slightly. ■

Connecting the units

Connection diagram

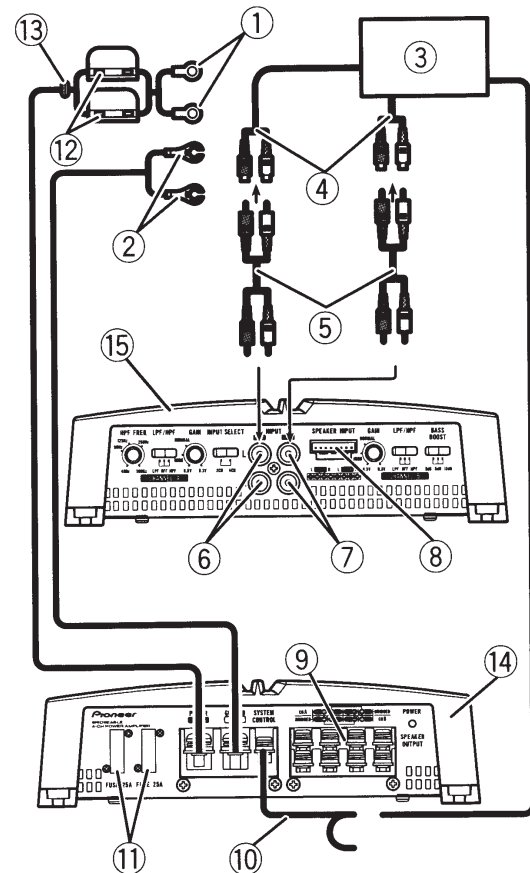

- ① Special red battery wire RD-223 (sold separately)
After completing all other amplifier connections, finally connect the battery wire terminal of the amplifier to the positive ⊕ battery terminal.
- ② Ground wire (Black) RD-223 (sold separately)
Connect to metal body or chassis.
- ③ Car stereo with RCA output jacks (sold separately)
- ④ External output
If only one input plug is used, do not connect anything to RCA input jack B.
- ⑤ Connecting wire with RCA pin plugs (sold separately)
- ⑥ RCA input jack A
- ⑦ RCA input jack B
- ⑧ Speaker input terminal (use a connector included)

Connecting the units

Please see the following section for speaker connection instructions. Refer to *Connections when using the speaker input wire*.

9. Speaker output terminals
Please see the following section for speaker connection instructions. Refer to *Connecting the speakers*.
10. System remote control wire (sold separately)
Connect male terminal of this wire to the system remote control terminal of the car stereo. The female terminal can be connected to the auto-antenna relay control terminal. If the car stereo lacks a system remote control terminal, connect the male terminal to the power terminal via the ignition switch.
11. Fuse 25 A × 2 (GM-A6704) / 30 A × 1 (GM-A4704)
12. Fuse (30 A) × 2
13. Grommet
14. Rear side
15. Front side

Note

INPUT SELECT (input select) switch must be set. For details, see *Setting the unit*. 

Before connecting the amplifier

WARNING

- Secure the wiring with cable clamps or adhesive tape. To protect the wiring, wrap sections in contact with metal parts in adhesive tape.
- Never cut the insulation of the power supply to feed power to other equipment. Current capacity of the wire is limited.

CAUTION

- Never shorten any wires, the protection circuit may malfunction.
- Never wire the speaker negative cable directly to ground.
- Never band together multiple speaker's negative cables.

- If the system remote control wire of the amplifier is connected to the power terminal via the ignition switch (12V DC), the amplifier will remain on with the ignition whether the car stereo is on or off, which may exhaust battery if the engine is at rest or idling.
- Install and route the separately sold battery wire as far as possible from the speaker wires. Install and route the separately sold battery wire, ground wire, speaker wires and the amplifier as far away as possible from the antenna, antenna cable and tuner. 

About bridged mode

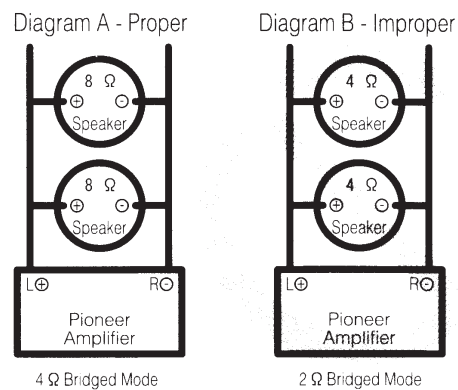

- Do not install or use this amplifier by wiring speakers rated at 4 Ω (or lower) in parallel to achieve a 2 Ω (or lower) bridged mode (Diagram B). Amplifier damage, smoke, and overheating could result from improper bridging. The amplifier surface could also become hot to the touch and minor burns could result. To properly install or use a bridged mode and achieve a 4 Ω load, wire two 8 Ω speakers in parallel with Left ⊕ and Right ⊖ (Diagram A) or use a single 4 Ω speaker. In addition, refer to the speaker instruction manual for information on the correct connection procedure.
- For any further enquiries, contact your local authorized Pioneer dealer or customer service. 

Connecting the units

About suitable specification of speaker

Ensure speakers conform to the following standards, otherwise there is a risk of fire, smoke or damage. Speaker impedance is $2\ \Omega$ to $8\ \Omega$, or $4\ \Omega$ to $8\ \Omega$ for two-channel and other bridge connections.

Subwoofer

Speaker channel	Power
Four-channel output	Nominal input: Min. 60 W (GM-A6704) Min. 40 W (GM-A4704)
Two-channel output	Nominal input: Min. 190 W (GM-A6704) Min. 130 W (GM-A4704)
Three-channel Speaker output A	Nominal input: Min. 60 W (GM-A6704) Min. 40 W (GM-A4704)
Three-channel Speaker output B	Nominal input: Min. 190 W (GM-A6704) Min. 130 W (GM-A4704)

Other than subwoofer

Speaker channel	Power
Four-channel output	Max. input: Min. 170 W (GM-A6704) Min. 80 W (GM-A4704)
Two-channel output	Max. input: Min. 500 W (GM-A6704) Min. 260 W (GM-A4704)
Three-channel Speaker output A	Max. input: Min. 170 W (GM-A6704) Min. 80 W (GM-A4704)
Three-channel Speaker output B	Max. input: Min. 500 W (GM-A6704) Min. 260 W (GM-A4704)



Connecting the speakers

The speaker output mode can be four-channel, three-channel (stereo and mono) or two-channel (stereo or mono). Connect the speaker leads based on the mode and the figures shown below.

Four-channel output

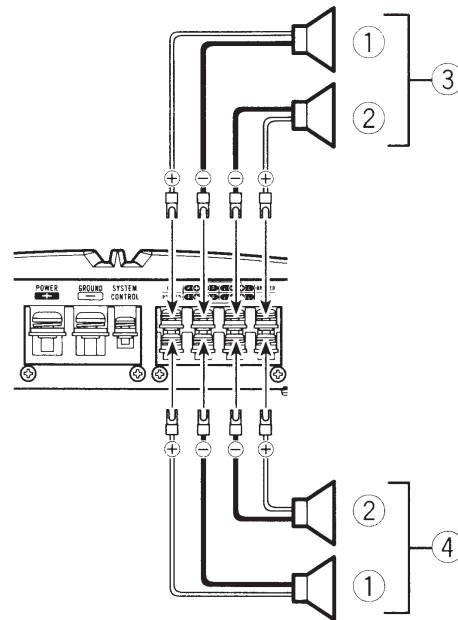

- ① Right
- ② Left
- ③ Speaker out A
- ④ Speaker out B

Connecting the units

Three-channel output

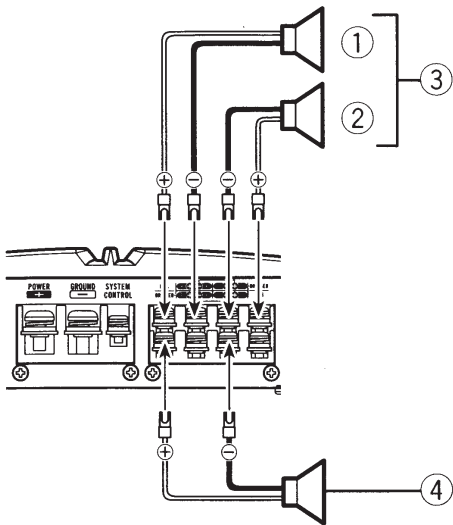

- ① Right
- ② Left
- ③ Speaker out A
- ④ Speaker out B (Mono)

Two-channel output (Stereo)

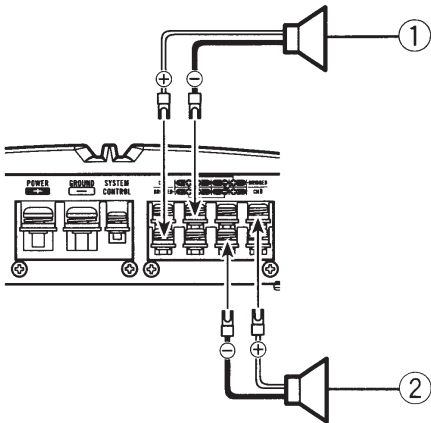

- ① Speaker (Right)
- ② Speaker (Left)

Two-channel output (Mono)

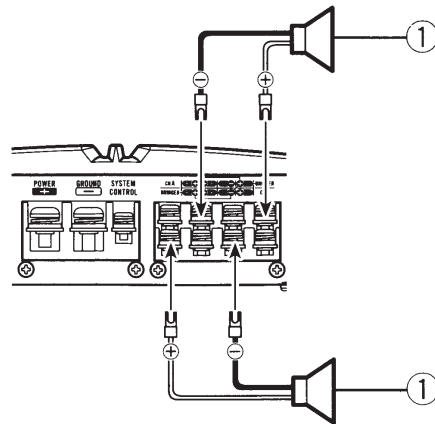

- ① Speaker (Mono)

Connections when using the RCA input jack

Connect the car stereo RCA output jack and the RCA input jack of the amplifier.

Four-channel / Three-channel output

- Slide **INPUT SELECT** (input select) switch to **4CH** position.

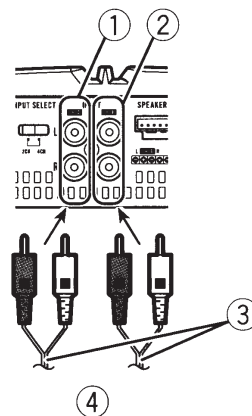

- ① RCA input jack A
- ② RCA input jack B
- ③ Connecting wires with RCA plugs (sold separately)
- ④ From car stereo (RCA output)

Connecting the units

If only one input plug is used, e.g. when the car stereo has only one output (RCA output), connect the plug to RCA input jack A rather than B.

Two-channel output (Stereo) / (Mono)

- Slide **INPUT SELECT** (input select) switch to **2CH** position.

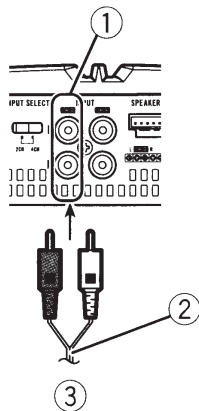

- RCA input jack A
For two-channel output, connect the RCA plugs to the RCA input jack A.
- Connecting wire with RCA pin plugs (sold separately)
- From car stereo (RCA output)

Connections when using the speaker input wire

Connect the car stereo speaker output wires to the amplifier using the supplied speaker input wire.

- Do not connect both the RCA input and the speaker input at the same time.

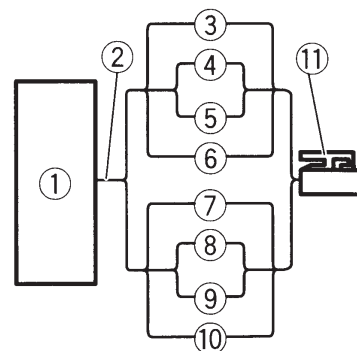

- Car Stereo
- Speaker output
- White/black: CH A, Left \ominus
- White: CH A, Left \oplus
- Gray/black: CH A, Right \ominus
- Gray: CH A, Right \oplus
- Green/black: CH B, Left \ominus
- Green: CH B, Left \oplus
- Violet/black: CH B, Right \ominus
- Violet: CH B, Right \oplus
- Speaker input connector
To speaker input terminal of this unit.

Note

If speaker input wires from a headunit are connected to this amplifier, the amplifier will automatically turn on when the headunit is turned on. When the headunit is turned off, the amplifier turns off automatically. This function may not work with some headunits. In such cases, make sure that the CH A Left channel is connected correctly. If the function still does not work, please use a system remote control wire (sold separately). If multiple amplifiers are to be connected together synchronously, connect the head unit and all amplifiers via the system remote control wire.

Connecting the units

Connecting the power terminal

The use of a special red battery and ground wire RD-223 (sold separately) is recommended. Connect the battery wire directly to the car battery positive terminal \oplus and the ground wire to the car body.

! WARNING

If the battery wire is not securely fixed to the terminal using the terminal screws, there is a risk of overheating, malfunction and injury, including minor burns.

1 Route battery wire from engine compartment to the vehicle interior.

- When drilling a cable pass-hole into the vehicle body and routing a battery wire thorough it, take care not to short-circuit the wire damaging it by the cut edges or burrs of the hole.

After completing all other amplifier connections, finally connect the battery wire terminal of the amplifier to the positive \oplus battery terminal.

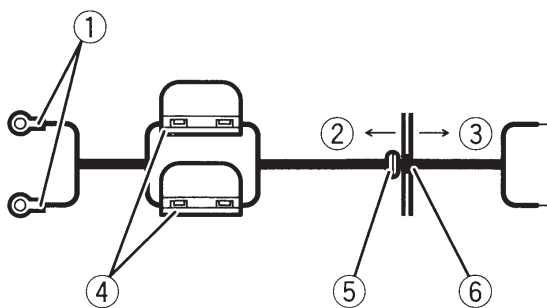

- ① Positive \oplus terminal
- ② Engine compartment
- ③ Vehicle interior
- ④ Fuse (30 A) \times 2
- ⑤ Insert the O-ring rubber grommet into the vehicle body.
- ⑥ Drill a 14 mm (1/2 in.) hole into the vehicle body.

2 Twist the battery wire, ground wire and system remote control wire.



3 Attach lugs to wire ends.

Use pliers, etc., to crimp lugs to wires.

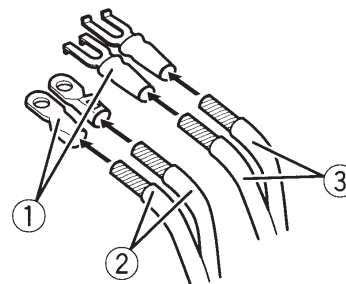

- ① Lug (sold separately)
- ② Battery wire
- ③ Ground wire

4 Connect the wires to the terminal.

Fix the wires securely with the terminal screws.

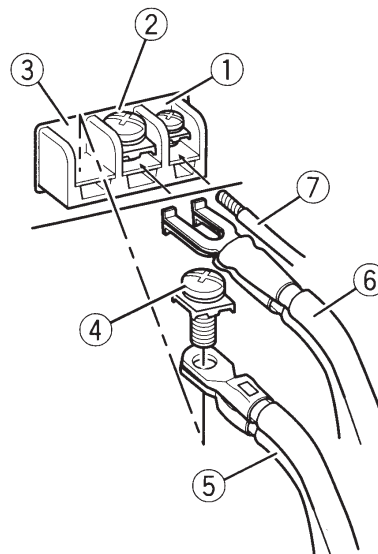

- ① System remote control terminal
- ② Ground terminal
- ③ Power terminal
- ④ Terminal screws
- ⑤ Battery wire
- ⑥ Ground wire
- ⑦ System remote control wire \blacksquare

Connecting the speaker output terminals

1 Use wire cutters or a utility knife to strip the end of the speaker wires to expose about 10 mm (3/8 in.) of wire and then twist the wire.

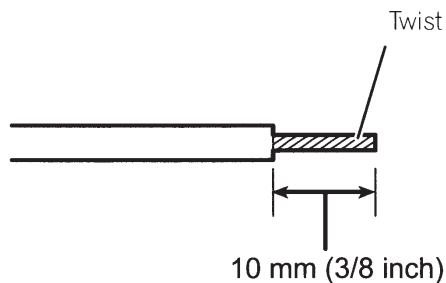

2 Attach lugs to wire ends.

Use pliers, etc., to crimp lugs to wires.

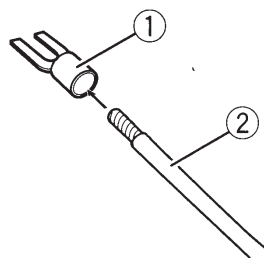

- ① Lug (sold separately)
- ② Speaker wire

3 Connect the speaker wires to the speaker output terminals.

Fix the speaker wires securely with the terminal screws.

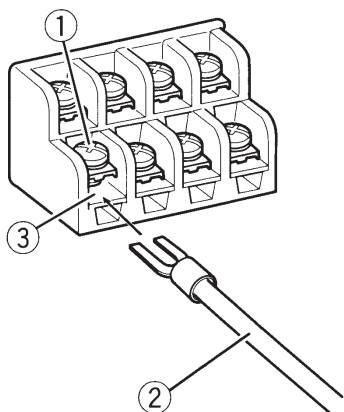

- ① Terminal screws
- ② Speaker wires
- ③ Speaker output terminals

Before installing the amplifier

! WARNING

- To ensure proper installation, use the supplied parts in the manner specified. If any parts other than those supplied are used, they may damage internal parts of the amplifier, or become loose causing the amplifier to shut down.
- Do not install in:
 - Places where it could injure the driver or passengers if the vehicle stops suddenly.
 - Places where it may interfere with the driver, such as on the floor in front of the driver's seat.
- Install tapping screws in such a way that the screw tip does not touch any wire. This is important to prevent wires from being cut by vibration of the car, which can result in fire.
- Make sure that wires do not get caught in the sliding mechanism of the seats or touch the legs of a person in the vehicle as short-circuit may result.
- When drilling to install the amplifier, always confirm no parts are behind the panel and protect all cables and important equipment (e.g. fuel/brake lines, wiring) from damage.

! CAUTION

- To ensure proper heat dissipation of the amplifier, ensure the following during installation:
 - Allow adequate space above the amplifier for proper ventilation.
 - Do not cover the amplifier with a floor mat or carpet.
- Protection function may activate to protect the amplifier against overheating due to installation in locations where sufficient heat cannot be dissipated, continuous use under high-volume conditions, etc. In such cases, the amplifier reduces the power output or shuts down until it has cooled to a certain designated temperature.
- Place all cables away from hot places, such as near the heater outlet.
- The optimal installation location differs depending on the car model. Secure the amplifier at a sufficiently rigid location.

Installation

- Check all connections and systems before final installation.
- After installing the amplifier, confirm that the spare tire, jack and tools can be easily removed.

Example of installation on the floor mat or chassis

1 Place the amplifier in the desired installation location.

Insert the supplied tapping screws (4 mm × 18 mm (1/8 in. × 3/4 in.)) into the screw holes and push on the screws with a screwdriver so they make an imprint where the installation holes are to be located.

2 Drill 2.5 mm (1/8 in.) diameter holes at the imprints either on the carpet or directly on the chassis.

3 Install the amplifier with the use of supplied tapping screws (4 mm × 18 mm (1/8 in. × 3/4 in.)).

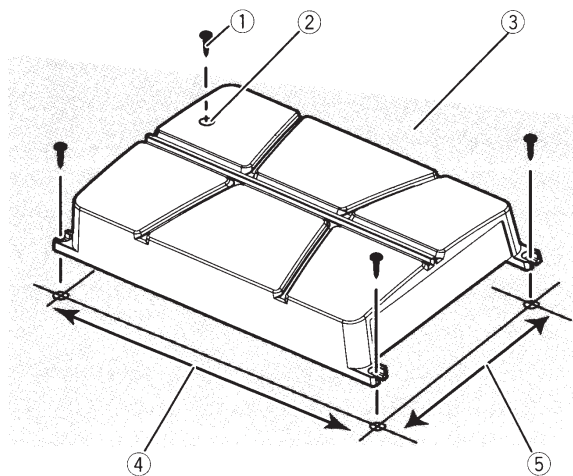

- ① Tapping-screws (4 mm × 18 mm (1/8 in. × 3/4 in.))
- ② Drill a 2.5 mm (1/8 in.) diameter hole.
- ③ Floor mat or chassis
- ④ Hole-to-hole distance: 343 mm (13-1/2 in.) (GM-A6704) / 313 mm (12-3/8 in.) (GM-A4704)
- ⑤ Hole-to-hole distance: 195 mm (7-5/8 in.)

Additional information

Specifications

GM-A6704

Power source	14.4 V DC (10.8 V to 15.1 V allowable)
Grounding system	Negative type
Current consumption	31 A (at continuous power, 4 Ω)
Average current consumption	8.5 A (4 Ω for four channels) 14 A (4 Ω for two channels)
Fuse	25 A × 2
Dimensions (W × H × D) ...	356 mm × 60 mm × 215 mm (14 in. × 2-3/8 in. × 8-1/2 in.)
Weight	2.2 kg (4.9 lbs) (Leads for wiring not included)
Maximum power output	170 W × 4 (4 Ω) / 250 W × 4 (2 Ω) / 1000 W TOTAL (BRIDGE)
Continuous power output ...	60 W × 4 (at 14.4 V, 4 Ω, 20 Hz to 20 kHz ≤ 1% THD +N) 190 W × 2 (at 14.4 V, 4 Ω BRIDGE 1 kHz, ≤ 1% THD +N) 95 W × 4 (at 14.4 V, 2 Ω, 1 kHz, ≤ 1% THD+N)
Load impedance	4 Ω (2 Ω to 8 Ω allowable)
Frequency response	10 Hz to 70 kHz (+0 dB, -3 dB)
Signal-to-noise ratio	95 dB (IHF-A network)
Distortion	0.05 % (10 W, 1 kHz)
Low pass filter:	
(A ch)	Cut off frequency 80 Hz Cut off slope -12 dB/oct
(B ch)	Cut off frequency 80 Hz Cut off slope -12 dB/oct
High pass filter:	
(A ch)	Cut off frequency 40 Hz to 500 Hz Cut off slope -12 dB/oct
(B ch)	Cut off frequency 80 Hz Cut off slope -12 dB/oct
Bass boost:	Frequency 50 Hz Level 0 dB/6 dB/12 dB
Gain control:	RCA 0.3 V to 6.5 V Speaker 3.0 V to 26 V
Maximum input level / impedance:	RCA 6.5 V / 22 kΩ Speaker 26 V / 16 kΩ

Additional information

CEA2006 Specifications



Power output	60 W RMS × 4 Channels (at 14.4 V, 4Ω and ≤ 1% THD +N)
S/N ratio	78 dBA (reference: 1 W into 4Ω)

GM-A4704

Power source	14.4 V DC (10.8 V to 15.1 V allowable)
Grounding system	Negative type
Current consumption	20.5 A (at continuous power, 4Ω)
Average current consumption	5.5 A (4Ω for four channels) 8.5 A (4Ω for two channels)
Fuse	30 A × 1
Dimensions (W × H × D) ...	326 mm × 60 mm × 215 mm (12-7/8 in. × 2-3/8 in. × 8-1/2 in.)
Weight	2.0 kg (4.4 lbs) (Leads for wiring not included)
Maximum power output	80 W × 4 (4Ω) / 130 W × 4 (2Ω) / 520 W TOTAL (BRIDGE)
Continuous power output ...	40 W × 4 (at 14.4 V, 4Ω, 20 Hz to 20 kHz ≤ 1% THD +N) 130 W × 2 (at 14.4 V, 4Ω BRIDGE 1 kHz, ≤ 1% THD +N) 65 W × 4 (at 14.4 V, 2Ω, 1 kHz, ≤ 1% THD +N)
Load impedance	4Ω (2Ω to 8Ω allowable)
Frequency response	10 Hz to 70 Hz (+0 dB, -3 dB)
Signal-to-noise ratio	94 dB (IHF-A network)
Distortion	0.05 % (10 W, 1 kHz)
Low pass filter:	
(A ch)	Cut off frequency 80 Hz Cut off slope -12 dB/oct
(B ch)	Cut off frequency 80 Hz Cut off slope -12 dB/oct
High pass filter:	
(A ch)	Cut off frequency 40 Hz to 500 Hz Cut off slope -12 dB/oct

(B ch)

Cut off frequency 80 Hz
Cut off slope -12 dB/oct

Gain control:

RCA 0.3 V to 6.5 V
Speaker 3.0 V to 26 V

Maximum input level / impedance:

RCA 6.5 V / 22 kΩ
Speaker 26 V / 16 kΩ

CEA2006 Specifications



Power output	40 W RMS × 4 Channels (at 14.4 V, 4Ω and ≤ 1% THD +N)
S/N ratio	78 dBA (reference: 1 W into 4Ω)

Notes

- Specifications and the design are subject to modifications without notice.
- The average current consumption is nearly the maximum current consumption by this unit when an audio signal is input. Use this value when working out total current consumption by multiple power amplifiers. ■

*Register your product at
Enregistrez votre produit au
Registre su producto en*

<http://www.pioneerelectronics.com>

*in Canada
au Canada
en Canadá* **<http://www.pioneerelectronics.ca>**

PIONEER CORPORATION

28-8, Honkomagome 2-chome, Bunkyo-ku,
Tokyo 113-0021, JAPAN

PIONEER ELECTRONICS (USA) INC.

P.O. Box 1540, Long Beach, California 90801-1540, U.S.A.
TEL: (800) 421-1404

PIONEER EUROPE NV

Haven 1087, Keetberglaan 1, B-9120 Melsele, Belgium/Belgique
TEL: (0) 3/570.05.11

PIONEER ELECTRONICS ASIACENTRE PTE. LTD.

2 Jalan Kilang Barat, #07-01, Singapore 159346
TEL: 65-6378-7888

PIONEER ELECTRONICS AUSTRALIA PTY. LTD.

5 Arco Lane, Heatherton, Victoria, 3202 Australia
TEL: (03) 9586-6300

PIONEER ELECTRONICS OF CANADA, INC.

340 Ferrier Street, Unit 2, Markham, Ontario L3R 2Z5, Canada
TEL: 1-877-283-5901
TEL: 905-479-4411

PIONEER ELECTRONICS DE MÉXICO S.A. de C.V.

Blvd.Manuel Ávila Camacho 138, 10 piso
Col.Lomas de Chapultepec, México, D.F. 11000
TEL: 52-55-9178-4270
FAX: 52-55-5202-3714

先鋒股份有限公司

台北市內湖區瑞光路407號8樓
電話：886-(0)2-2657-3588

先鋒電子(香港)有限公司

香港九龍長沙灣道909號5樓
電話：852-2848-6488

© 2016 PIONEER CORPORATION.
All rights reserved.

© 2016 PIONEER CORPORATION.
Tous droits de reproduction et de
traduction réservés.



PIONEER ELECTRONICS (USA) INC.

PIONEER ELECTRONIQUE DU CANADA, INC.

GARANTIE LIMITÉE
GARANTIE VALIDE SEULEMENT DANS LE PAYS OU LE PRODUIT A ÉTÉ ACHETÉ

GARANTIE

Pioneer Electronics (USA) Inc. (PUSA) et Pioneer Électronique du Canada, Inc. (POC) garantissent que les produits distribués par PUSA aux États-Unis et par POC au Canada qui, après avoir été installés et utilisés conformément au manuel de l'utilisateur inclus avec l'unité, ne fonctionnent pas de façon appropriée dans des conditions d'utilisation normales en raison d'un vice de fabrication, seront réparés ou remplacés par une unité de valeur comparable, au choix de PUSA ou de POC, sans que vous deviez payer pour les pièces ou les travaux de réparation. Les unités ou pièces de rechange fournies en vertu de la présente garantie peuvent être neuves ou remises à neuf, au choix de PUSA ou de POC.

LA PRÉSENTE GARANTIE LIMITÉE S'APPLIQUE AU PROPRIÉTAIRE INITIAL AINSI QU'À TOUT PROPRIÉTAIRE SUBSÉQUENT DU PRÉSENT PRODUIT PIONEER PENDANT LA PÉRIODE DE GARANTIE, À CONDITION QUE LE PRODUIT AIT ÉTÉ ACHETÉ CHEZ UN DISTRIBUTEUR OU MARCHAND PIONEER AUTORISÉ AUX ÉTATS-UNIS OU AU CANADA. VOUS DEVREZ FOURNIR UN RELEVÉ DE CAISSE OU UNE AUTRE PREUV E D'ACHAT VALIDE INDIQUANT LA DATE DE L'ACHAT INITIAL OU, SI VOUS LOUEZ LE PRODUIT, VOTRE CONTRAT DE LOCATION INDIQUANT L'ENDROIT ET LA DATE DE LA PREMIÈRE LOCATION. SI JAMAIS UN SERVICE DE RÉPARATION EST REQUIS, LE PRODUIT DOIT ÊTRE EXPÉDIÉ PENDANT LA PÉRIODE DE GARANTIE, EN PORT PRÉPAYÉ, À L'INTÉRIEUR DU PAYS OU L'ACHAT A ÉTÉ EFFECTUÉ SEULEMENT, TEL QU'IL EST EXPLIQUÉ DANS LE PRÉSENT DOCUMENT. VOUS ÊTES RESPONSABLE DU DÉMONTAGE ET DE L'INSTALLATION DU PRODUIT. PUSA OU POC, LE CAS ÉCHÉANT, PAIERA POUR VOUS RETOURNER LE PRODUIT RÉPARÉ OU REMPLACÉ, À L'INTÉRIEUR DU PAYS OU L'ACHAT A ÉTÉ EFFECTUÉ.

PÉRIODE DE GARANTIE DES PRODUITS

	Pièces	Main-d'œuvre
Produits stéréo pour l'auto	1 an	1 an

La période de garantie pour les clients qui louent le produit commence le jour où le produit est utilisé pour la première fois (a) pendant la période de location ou (b) après la vente au détail, selon ce qui se produit en premier.

ÉLÉMENTS NON COUVERTS PAR LA GARANTIE

UN PRODUIT ACHETÉ CHEZ UN DISTRIBUTEUR NON AUTORISÉ N'EST COUVERT PAR AUCUNE GARANTIE EXPRESSE OU IMPLICITE, Y COMPRIS QUELQUE GARANTIE IMPLICITE DE QUALITÉ MARCHANDE OU D'ADAPTATION À UN USAGE PARTICULIER QUE CE SOIT. DE PLUS, CE PRODUIT EST STRICTEMENT VENDU " TEL QUEL " ET " AVEC TOUS SES DÉFAUTS ÉVENTUELS ".

PIONEER N'EST PAS RESPONSABLE DE QUELQUE DOMMAGE CONSÉCUTIF ET(OU) INDIRECT QUE CE SOIT.

PIONEER NE GARANTIT PAS LES PRODUITS ÉNUMÉRÉS CI-DESSUS LORSQU'ILS SONT UTILISÉS À DES FINS COMMERCIALES OU PROFESSIONNELLES, OU AU SEIN DE TOUTE APPLICATION INDUSTRIELLE OU COMMERCIALE QUE CE SOIT.

LA PRÉSENTE GARANTIE NE S'APPLIQUE PAS SI LE PRODUIT A ÉTÉ SOUMIS À UNE PUISSANCE NOMINALE EXCÉDANT CELLE QUI A ÉTÉ ÉTABLIE DANS LES DOCUMENTS S'Y APPLIQUANT.

LA PRÉSENTE GARANTIE NE COUVRE PAS LES TÉLÉVISEURS OU LES ÉCRANS ENDOMMAGÉS EN RAISON DE L'APPLICATION D'IMAGES STATIQUES ET IMMOBILES PENDANT DE LONGUES PÉRIODES (IMAGES RÉMANENTES).

LA PRÉSENTE GARANTIE NE COUVRE PAS LE COFFRAGE OU LES ÉLÉMENTS ESTHÉTIQUES, LES ANTENNES INSTALLÉES PAR L'UTILISATEUR, LES DOMMAGES AUX DISQUES OU AUX RUBANS OU DISQUES D'ENREGISTREMENT, LES DOMMAGES AU PRODUIT DÉCOULANT D'UNE RETOUCHE, D'UNE MODIFICATION NON AUTORISÉE PAR ÉCRIT PAR PIONEER, D'UN ACCIDENT, D'UN USAGE INAPPROPRIÉ OU D'UN USAGE ABUSIF, LES DOMMAGES PRODUITS PAR LA Foudre OU LA SURTENSION, LES DOMMAGES SUBSÉQUENTS DÉCOULANT DE FUITES, LES DOMMAGES DÉCOULANT DE PILES DÉFECTUEUSES OU DE L'UTILISATION DE PILES NON CONFORMES À CELLES QUI SONT SPÉCIFIÉES DANS LE MANUEL DE L'UTILISATEUR.

LA PRÉSENTE GARANTIE NE COUVRE PAS LE COÛT DES PIÈCES OU DE LA MAIN-D'ŒUVRE QUI SERAIENT AUTREMENT OFFERTES SANS FRAIS EN VERTU DE LA PRÉSENTE GARANTIE, SI ELLES SONT OBTENUES AUPRÈS D'UNE SOURCE AUTRE QU'UNE SOCIÉTÉ DE SERVICE OU AUTRE AUTORISÉE OU DÉSIGNÉE PAR PIONEER. LA PRÉSENTE GARANTIE NE COUVRE PAS LES DÉFECTUOSITÉS OU LES DOMMAGES CAUSÉS PAR L'UTILISATION D'UNE MAIN-D'ŒUVRE OU DE PIÈCES NON AUTORISÉES, NI D'UN ENTRETIEN INADÉQUAT.

LES NUMÉROS DE SÉRIE MODIFIÉS, OBLITÉRÉS OU ENLEVÉS ANNULENT LA PRÉSENTE GARANTIE DANS SA TOTALITÉ.

INVALIDITÉ DE TOUTE AUTRE GARANTIE

AUX ÉTATS-UNIS - PIONEER LIMITE SES OBLIGATIONS EN VERTU DE TOUTE GARANTIE IMPLICITE QUE CE SOIT, Y COMPRIS ENTRE AUTRES LES GARANTIES IMPLICITES DE QUALITÉ MARCHANDE OU D'ADAPTATION À UN USAGE PARTICULIER, À UNE PÉRIODE N'EXCÉDANT PAS LA PÉRIODE DE GARANTIE. AUCUNE GARANTIE NE S'APPLIQUE APRÈS LA PÉRIODE DE GARANTIE. CERTAINS ÉTATS NE PERMETTENT PAS LA LIMITATION DE LA DURÉE D'UNE GARANTIE IMPLICITE, ET CERTAINS NE PERMETTENT PAS L'EXCLUSION OU LA LIMITATION DES DOMMAGES CONSÉCUTIFS OU INDIRECTS. LES LIMITATIONS ET EXCLUSIONS ÉTABLIES CI-DESSUS PEUVENT DONC NE PAS S'APPLIQUER À VOUS. LA PRÉSENTE GARANTIE VOUS DONNE DES DROITS LÉGAUX SPÉCIFIQUES. VOUS POUVEZ JOUIR D'AUTRES DROITS, QUI PEUVENT VARIER D'UN ÉTAT À L'AUTRE.

AU CANADA - SOUS RÉSERVE DE CE QUI EST EXPRESSÉMENT STIPULÉ DANS LES PRÉSENTES, AUCUNE REPRÉSENTATION, GARANTIE, OBLIGATION OU CONDITION, QU'ELLE SOIT IMPLICITE, OBLIGATOIRE OU AUTRE, NE S'APPLIQUE À CE PRODUIT.

SERVICE

Pour profiter du service en vertu de la garantie aux États-Unis et au Canada, vous devez présenter votre relevé de caisse ou, si vous louez le produit, votre contrat de location indiquant l'endroit et la date de la transaction par le premier propriétaire.

AUX ÉTATS-UNIS - Communiquez avec un des partenaires Pioneer suivants pour le service :

Votre marchand Pioneer autorisé - Votre marchand Pioneer peut réparer ou remplacer votre unité, ou bien vous diriger vers une société de service Pioneer autorisée. Votre reçu de caisse devrait énumérer ses coordonnées (numéros de téléphone et de télécopieur, courriel, etc.).

Votre société de service autorisée - Celle-ci peut réparer la plupart des produits électroniques pour l'auto et vous aviser des options supplémentaires qui pourraient s'appliquer. Veuillez accéder au site Web de Pioneer à www.pioneerelectronics.com, cliquer sur l'onglet " Support " et choisir " Find a Service Center " pour trouver la société de service Pioneer la plus proche.

Pioneer Customer Support - Ce service peut vous aviser des options de service optimales pour votre modèle et votre emplacement géographique. Veuillez consulter les coordonnées ci-dessous pour communiquer avec Pioneer par téléphone, par courrier ou par le biais de son site Web.

AU CANADA - POC a désigné un certain nombre de sociétés de service autorisées partout au Canada si jamais vous avez besoin de services de réparation pour votre produit. Communiquez avec Pioneer Électronique du Canada (les coordonnées se trouvent ci-dessous) pour trouver une société de service autorisée.

Expédition de votre unité aux fins de service - Si vous expédiez l'unité, vous devez l'emballer soigneusement et l'envoyer à une société de service autorisée ou à Pioneer, en port prépayé et selon une méthode de transport pouvant être suivie et assurée. Emballez le produit au moyen de matériaux coussinés adéquats pour éviter les dommages pendant le transport. Incluez votre nom, votre adresse et un numéro de téléphone où nous pouvons vous joindre pendant les heures de bureau.

Pour toutes les plaintes et problèmes aux États-Unis, communiquez avec le service de Soutien à la clientèle au 1-800-421-1404. Au Canada, communiquez avec le groupe de Soutien à la clientèle au 1-877-283-5901.

Pour le raccordement ou le fonctionnement de votre unité, ou pour trouver une société de service autorisée, appelez ou écrivez à :

AUX ÉTATS-UNIS
 CUSTOMER SUPPORT
 PIONEER ELECTRONICS (USA) INC.
 P.O. BOX 1720
 LONG BEACH, CALIFORNIA 90801
 1-800-421-1404
<http://www.pioneerelectronics.com>

AU CANADA
 GROUPE DE SATISFACTION DE LA CLIENTÈLE
 PIONEER ÉLECTRONIQUE DU CANADA, INC.
 340 FERRIER STREET, UNIT 2
 MARKHAM, ON L3R 2Z5
 (905) 479-4411
 1-877-283-5901
<http://www.pioneerelectronics.ca>

RÈGLEMENT DES CONFLITS

AUX ÉTATS-UNIS - Si un conflit se produit entre vous et Pioneer après la réponse à une demande initiale faite au service de Soutien à la clientèle, vous pouvez avoir recours au Programme de résolution des plaintes de Pioneer pour résoudre le conflit. Ce programme vous est offert sans frais. Vous devez avoir recours au Programme de résolution des plaintes avant de vous prévaloir de vos droits ou de chercher réparation en vertu du Titre I de la loi Magnuson-Moss Warranty-Federal Trade Commission Improvement Act, 15 U.S.C. 2301 et s.s.

Pour avoir recours au Programme de résolution des plaintes, appelez au 1 800 421-1404 et expliquez au représentant du service à la clientèle qui vous répondra le problème auquel vous faites face et les démarches que vous avez entreprises pour faire réparer le produit pendant la période de garantie, puis donnez-lui le nom du distributeur / marchand autorisé auprès duquel vous vous êtes procuré le produit Pioneer. Une fois que votre plainte a été expliquée au représentant, un numéro de résolution vous sera communiqué. Pioneer étudiera le conflit et, dans un délai de quarante (40) jours après la réception de votre plainte, (1) répondra à votre plainte par écrit pour vous aviser des démarches qu'elle entreprendra pour résoudre le conflit, et indiquera combien de temps ces démarches prendront ; ou (2) répondra à votre plainte par écrit pour vous indiquer les raisons pour lesquelles elle n'entreprendra aucune démarche.

AU CANADA - Communiquez avec le directeur de la Soutien à la clientèle au (905) 946-7412 pour discuter de votre plainte et résoudre rapidement le problème.

ENREGISTREZ LE LIEU ET LA DATE D'ACHAT POUR RÉFÉRENCE ULTÉRIEURE

No. du modèle : _____ No. de série : _____
 Date d'achat : _____ Acheté de : _____

PRENEZ SOIN DE GARDER CETTE INFORMATION ET VOTRE REÇU D'ACHAT DANS UN ENDROIT SÛR

< QRY3001-B/S >

Imprimé en Chine



PIONEER ELECTRONICS (USA) INC.

PIONEER ELECTRONICS OF CANADA, INC.

LIMITED WARRANTY

WARRANTY VALID ONLY IN COUNTRY OF PRODUCT PURCHASE

WARRANTY

Pioneer Electronics (USA) Inc. (PUSA), and Pioneer Electronics Of Canada, Inc. (POC), warrant that products distributed by PUSA in the U.S.A., and by POC in Canada that fail to function properly under normal use due to a manufacturing defect when installed and operated according to the owner's manual enclosed with the unit will be repaired or replaced with a unit of comparable value, at the option of PUSA or POC, without charge to you for parts or actual repair work. Replacement units and/or parts supplied under this warranty may be new or rebuilt at the option of PUSA or POC.

THIS LIMITED WARRANTY APPLIES TO THE ORIGINAL OR ANY SUBSEQUENT OWNER OF THIS PIONEER PRODUCT DURING THE WARRANTY PERIOD PROVIDED THE PRODUCT WAS PURCHASED FROM AN AUTHORIZED PIONEER DISTRIBUTOR/DEALER IN THE U.S.A. OR CANADA. YOU WILL BE REQUIRED TO PROVIDE A SALES RECEIPT OR OTHER VALID PROOF OF PURCHASE SHOWING THE DATE OF ORIGINAL PURCHASE OR, IF RENTED, YOUR RENTAL CONTRACT SHOWING THE PLACE AND DATE OF FIRST RENTAL. IN THE EVENT SERVICE IS REQUIRED, THE PRODUCT MUST BE DELIVERED WITHIN THE WARRANTY PERIOD, TRANSPORTATION PREPAID, ONLY FROM WITHIN THE COUNTRY OF PURCHASE AS EXPLAINED IN THIS DOCUMENT. YOU WILL BE RESPONSIBLE FOR REMOVAL AND INSTALLATION OF THE PRODUCT. PUSA OR POC, AS APPROPRIATE, WILL PAY TO RETURN THE REPAIRED OR REPLACEMENT PRODUCT TO YOU WITHIN THE COUNTRY OF PURCHASE.

PRODUCT WARRANTY PERIOD

	<u>Parts</u>	<u>Labor</u>
Car Stereo Products	1 Year	1 Year

The warranty period for retail customers who rent the product commences upon the date product is first put into use (a) during the rental period or (b) retail sale, whichever occurs first.

WHAT IS NOT COVERED

IF THIS PRODUCT WAS PURCHASED FROM AN UNAUTHORIZED DISTRIBUTOR, THERE ARE NO WARRANTIES, EXPRESS OR IMPLIED, INCLUDING THE IMPLIED WARRANTY OF MERCHANTABILITY AND THE IMPLIED WARRANTY OF FITNESS FOR A PARTICULAR PURPOSE AND THIS PRODUCT IS SOLD STRICTLY "AS IS" AND "WITH ALL FAULTS".

PIONEER SHALL NOT BE LIABLE FOR ANY CONSEQUENTIAL AND/OR INCIDENTAL DAMAGES.

PIONEER DOES NOT WARRANT ANY PRODUCT LISTED ABOVE WHEN IT IS USED IN A TRADE OR BUSINESS OR IN ANY INDUSTRIAL OR COMMERCIAL APPLICATION.

THIS WARRANTY DOES NOT APPLY IF THE PRODUCT HAS BEEN SUBJECTED TO POWER IN EXCESS OF ITS PUBLISHED POWER RATING.

THIS WARRANTY DOES NOT COVER DISPLAY SCREENS DAMAGED BY STATIC, NON-MOVING, IMAGES APPLIED FOR LENGTHY PERIODS (BURN-IN).

THIS WARRANTY DOES NOT COVER THE CABINET OR ANY APPEARANCE ITEM, USER ATTACHED ANTENNA, ANY DAMAGE TO RECORDS OR RECORDING TAPES OR DISCS, ANY DAMAGE TO THE PRODUCT RESULTING FROM ALTERATIONS, MODIFICATIONS NOT AUTHORIZED IN WRITING BY PIONEER, ACCIDENT, MISUSE OR ABUSE, DAMAGE DUE TO LIGHTNING OR TO POWER SURGES, SUBSEQUENT DAMAGE FROM LEAKING, DAMAGE FROM INOPERATIVE BATTERIES, OR THE USE OF BATTERIES NOT CONFORMING TO THOSE SPECIFIED IN THE OWNER'S MANUAL.

THIS WARRANTY DOES NOT COVER THE COST OF PARTS OR LABOR WHICH WOULD BE OTHERWISE PROVIDED WITHOUT CHARGE UNDER THIS WARRANTY OBTAINED FROM ANY SOURCE OTHER THAN A PIONEER AUTHORIZED SERVICE COMPANY OR OTHER DESIGNATED LOCATION. THIS WARRANTY DOES NOT COVER DEFECTS OR DAMAGE CAUSED BY THE USE OF UNAUTHORIZED PARTS OR LABOR OR FROM IMPROPER MAINTENANCE.

ALTERED, DEFACED, OR REMOVED SERIAL NUMBERS VOID THIS ENTIRE WARRANTY

NO OTHER WARRANTIES

IN THE U.S.A. - PIONEER LIMITS ITS OBLIGATIONS UNDER ANY IMPLIED WARRANTIES INCLUDING, BUT NOT LIMITED TO, THE IMPLIED WARRANTIES OF MERCHANTABILITY AND FITNESS FOR A PARTICULAR PURPOSE, TO A PERIOD NOT TO EXCEED THE WARRANTY PERIOD. NO WARRANTIES SHALL APPLY AFTER THE WARRANTY PERIOD. SOME STATES DO NOT ALLOW LIMITATIONS ON HOW LONG AN IMPLIED WARRANTY LASTS AND SOME STATES DO NOT ALLOW THE EXCLUSIONS OR LIMITATIONS OF INCIDENTAL OR CONSEQUENTIAL DAMAGES, SO THE ABOVE LIMITATIONS OR EXCLUSIONS MAY NOT APPLY TO YOU. THIS WARRANTY GIVES YOU SPECIFIC LEGAL RIGHTS AND YOU MAY HAVE OTHER RIGHTS WHICH MAY VARY FROM STATE TO STATE.

IN CANADA - EXCEPT AS EXPRESSLY PROVIDED HEREIN, THERE ARE NO REPRESENTATIONS, WARRANTIES, OBLIGATIONS OR CONDITIONS, IMPLIED, STATUTORY OR OTHERWISE, APPLICABLE TO THIS PRODUCT.

TO OBTAIN SERVICE

In the U.S.A. or Canada to receive warranty service you need to present your sales receipt or your rental contract showing place and date of original owner's transaction.

USA - Please contact one of the following Pioneer partners to obtain service:

Your Authorized Pioneer Dealer - Your Dealer may repair or replace your unit, or refer you to an Authorized Pioneer Service Company. Your sales receipt should list the contact information (phone number, fax, email, etc.) for your Dealer.

Your Authorized Pioneer Service Company - Can perform repairs for most Car Electronics products and can advise other options as applicable. Please access the Pioneer website at www.pioneerelectronics.com and click on "Support" and select "Find a Service Center" to find the nearest Pioneer servicer.

Pioneer Customer Support - Can advise the optimal service option for your model and geographic location. Please reference the information listed below and phone, email or access the Pioneer website to contact Pioneer.

CANADA - POC has a number of Authorized Service Companies should your product require service. Contact Pioneer of Canada as listed below to obtain a local service location.

Shipping Your Unit for Service - Please package it carefully and send it, transportation prepaid by a traceable, insured method, to an Authorized Service Company or Pioneer. Use adequate padding material to prevent damage in transit. Include your name, address and telephone number where you can be reached during business hours.

On all complaints and concerns in the U.S.A. call Customer Support at 1-800-421-1404, or, in Canada, call Customer Satisfaction at (905) 479-4411.

IN THE U.S.A.

For hook-up and operation of your unit or to locate an Authorized Service Company, please call or write:
CUSTOMER SUPPORT / PIONEER ELECTRONICS (USA) INC.

P.O. BOX 1720
LONG BEACH, CALIFORNIA 90801
1-800-421-1404

<http://www.pioneerelectronics.com>

IN CANADA

For additional information on this warranty, please call or write:

CUSTOMER SATISFACTION GROUP
PIONEER ELECTRONICS OF CANADA, INC.
340 FERRIER STREET, UNIT 2
MARKHAM, ON L3R 2Z5

(905) 479-4411 1-877-283-5901

<http://www.pioneerelectronics.ca>

DISPUTE RESOLUTION

IN THE U.S.A. - Following our response to any initial request to Customer Support, should a dispute arise between you and Pioneer, Pioneer makes available its Complaint Resolution Program to resolve the dispute. The Complaint Resolution Program is available to you without charge. You are required to use the Complaint Resolution Program before you exercise any rights under, or seek any remedies, created by Title I of the Magnuson-Moss Warranty-Federal Trade Commission Improvement Act, 15 U.S.C. 2301 et seq.

To use the Complaint Resolution Program call 1-800-421-1404 and explain to the customer service representative the problem you are experiencing, steps you have taken to have the product repaired during the warranty period and the name of the authorized Distributor/Dealer from whom the Pioneer product was purchased. After the complaint has been explained to the representative, a resolution number will be issued. Within 40 days of receiving your complaint, Pioneer will investigate the dispute and will either: (1) respond to your complaint in writing informing you what action Pioneer will take, and in what time period, to resolve the dispute; or (2) respond to your complaint in writing informing you why it will not take any action.

IN CANADA - Call the Customer Satisfaction Manager at (905) 946-7412 to discuss your complaint and to obtain a prompt resolution.

RECORD THE PLACE AND DATE OF PURCHASE FOR FUTURE REFERENCE

Model No. _____ Serial No. _____ Purchase Date _____

Purchased From _____

KEEP THIS INFORMATION AND YOUR SALES RECEIPT IN A SAFE PLACE

< QRY3001-B/S >