

Pioneer

Owner's Manual
Mode d'emploi

CLASS D MONO AMPLIFIER
AMPLIFICATEUR MONO DE CLASSE D

GM-D8701

GM-DX871

GM-D9701

GM-DX971

English
Français

Before you start

Thank you for purchasing this PIONEER product

To ensure proper use, please read through this manual before using this product. It is especially important that you read and observe **WARNING**s and **CAUTION**s in this manual. *Please keep the manual in a safe and accessible place for future reference.*



Information to User

Alteration or modifications carried out without appropriate authorization may invalidate the user's right to operate the equipment.

Note

This equipment has been tested and found to comply with the limits for a Class B digital device, pursuant to Part 15 of the FCC Rules. These limits are designed to provide reasonable protection against harmful interference in a residential installation. This equipment generates, uses and can radiate radio frequency energy and, if not installed and used in accordance with the instructions, may cause harmful interference to radio communications. However, there is no guarantee that interference will not occur in a particular installation. If this equipment does cause harmful interference to radio or television reception, which can be determined by turning the equipment off and on, the user is encouraged to try to correct the interference by one or more of the following measures:

- Reorient or relocate the receiving antenna.
- Increase the separation between the equipment and receiver.
- Connect the equipment into an outlet on a circuit different from that to which the receiver is connected.
- Consult the dealer or an experienced radio/TV technician for help.

FEDERAL COMMUNICATIONS
COMMISSION SUPPLIER'S DECLARATION
OF CONFORMITY

Product Name: Class D Mono Amplifier

Model Number: GM-D8701/GM-DX871/
GM-D9701/GM-DX971

Responsible Party Name: PIONEER
ELECTRONICS (USA) INC.

SERVICE SUPPORT DIVISION

Address: 2050 W. 190TH STREET, SUITE 100,
TORRANCE, CA 90504, U.S.A.

Phone: 1-800-421-1404

URL: <https://www.pioneerelectronics.com/PUSA/>



After-sales service for Pioneer products

Please contact the dealer or distributor from where you purchased this unit for after-sales service (including warranty conditions) or any other information. In case the necessary information is not available, please contact the companies listed below:

Please do not ship your unit to the companies at the addresses listed below for repair without advance contact.

USA & CANADA

Pioneer Electronics (USA) Inc.
CUSTOMER SUPPORT DIVISION
P.O. Box 1760
Long Beach, CA 90801-1760
800-421-1404

For warranty information, please see the Limited Warranty sheet included with this unit.

If you experience problems

Should this product fail to operate properly, please contact your dealer or nearest authorized Pioneer Service Station.

Visit our website

<http://www.pioneerelectronics.com>

in Canada

<http://www.pioneerelectronics.ca>

Before you start

- Learn about product updates (such as firmware updates) for your product.
- Register your product to receive notices about product updates and to safeguard purchase details in our files in the event of loss or theft.
- Access owner's manuals, spare parts information, service information, and much more. 

The Safety of Your Ears is in Your Hands

Get the most out of your equipment by playing it at a safe level—a level that lets the sound come through clearly without annoying blaring or distortion and, most importantly, without affecting your sensitive hearing. Sound can be deceiving. Over time, your hearing “comfort level” adapts to higher volumes of sound, so what sounds “normal” can actually be loud and harmful to your hearing. Guard against this by setting your equipment at a safe level BEFORE your hearing adapts.

ESTABLISH A SAFE LEVEL:

- Set your volume control at a low setting.
- Slowly increase the sound until you can hear it comfortably and clearly, without distortion.
- Once you have established a comfortable sound level, set the dial and leave it there.

BE SURE TO OBSERVE THE FOLLOWING GUIDELINES:

- Do not turn up the volume so high that you can't hear what's around you.
- Use caution or temporarily discontinue use in potentially hazardous situations.
- Do not use headphones while operating a motorized vehicle; the use of headphones may create a traffic hazard and is illegal in many areas. 

About This Product

This product is a mono amplifier for subwoofer. If both L (left) and R (right) channels are connected

to the RCA input of this product, output is mixed because this product is a mono amplifier. 

Before connecting/ installing the amplifier

WARNING

- This product contains chemicals known to the State of California and other governmental entities to cause cancer and birth defects or other reproductive harm. **Wash hands after handling.**
- Slots and openings in the cabinet are provided for ventilation to ensure reliable operation of the product, and to protect it from overheating. To prevent fire hazard, the openings should never be blocked or covered with items (such as papers, floor mat, cloths).
- This unit is for vehicles with a 12 V battery and negative grounding. Before installing in recreational vehicles, trucks or buses, check the battery voltage.
- When installing this unit, make sure to connect the ground wire first. Ensure that the ground wire is properly connected to the metal parts of the car's body. The ground wire of the one of this unit must be connected to the car separately with different screws. If the screw for the ground wire loosens or falls out, it could result in fire, generation of smoke or malfunction.
- Be sure to install the fuse to the battery wire.
- Always use a fuse of the rating prescribed. The use of an improper fuse could result in overheating and smoke, damage to the product, and injury, including burns.
- Check the connections of the power supply and speakers if the fuse of the separately sold battery wire or the amplifier fuse blows. Determine and resolve the cause, then replace the fuse with an identical equivalent.
- Always install the amplifier on a flat surface. Do not install the amplifier on a surface that is not flat or on a surface with a protrusion. Doing so could result in malfunction.
- When installing the amplifier, do not allow parts such as extra screws to get caught between the amplifier and the automobile. Doing so could cause malfunction.

Before you start

- Do not allow this unit to come into contact with liquids. Electrical shock could result. Also, damage to this unit, smoke, and overheating could result from contact with liquids. The surfaces of the amplifier and any attached speakers may also heat up and cause minor burns.
- In the event of any abnormality, the power supply to the amplifier is cut off to prevent equipment malfunction. If this occurs, switch the system power off and check the power supply and speaker connections. If you are unable to determine the cause, please contact your dealer.
- Always disconnect the negative \ominus terminal of the battery beforehand to avoid the risk of electric shock or short circuit during installation.
- Do not attempt to disassemble or modify this unit. Doing so may result in fire, electric shock or other malfunction.

CAUTION

- Always keep the volume low enough to hear outside sounds.
- Extended use of the car stereo while the engine is at rest or idling may exhaust the battery.
- This product is evaluated in moderate and tropical climate condition under the Audio, video and similar electronic apparatus - Safety requirements, IEC 60065.
- The graphical symbol  placed on the product means direct current.
- Connect either of three subwoofers to the amplifier; 1: a subwoofer with a 300 W (GM-D8701 and GM-DX871) / 500 W (GM-D9701 and GM-DX971) or larger nominal input and an impedance 4 Ω , 2: a subwoofer with a 500 W (GM-D8701 and GM-DX871) / 800 W (GM-D9701 and GM-DX971) or larger nominal input and an impedance 2 Ω or 3: a subwoofer with a 800 W (GM-D8701 and GM-DX871) / 1 200 W (GM-D9701 and GM-DX971) or larger nominal input and an impedance 1 Ω .

If the nominal input and impedance are out of the above ranges, the subwoofer may catch fire, emit smoke or become damaged.

About the protection function

This product has protection function. When this product detects something abnormal, the following functions will operate to protect the product and speaker output.

- The **POWER/PROTECT** indicator will turn red and the amplifier will shut down in the situations outlined below.
 - If the temperature inside the amplifier gets too high.
 - If a DC voltage is applied to the speaker output terminal.
- The **POWER/PROTECT** indicator will turn red and the output will be muted in the situations outlined below.
 - If the speaker output terminal and speaker wire are short-circuited.



Important (Serial number)

The serial number is located on the bottom of this unit. For your own security and convenience, be sure to record this number on the enclosed warranty card. 

Setting the unit

What's what

GM-D8701 and GM-DX871

Front side

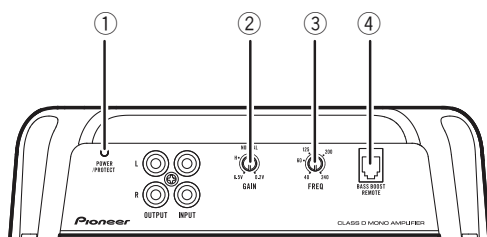

Rear side

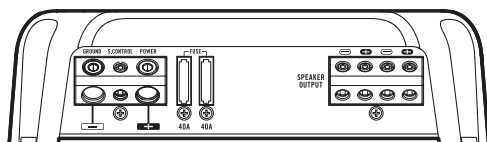

GM-D9701 and GM-DX971

Front side

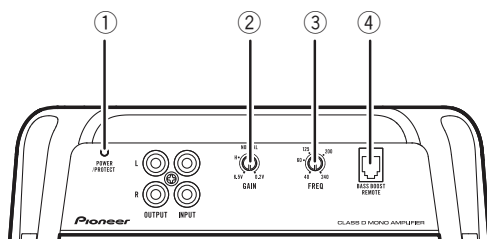

Rear side

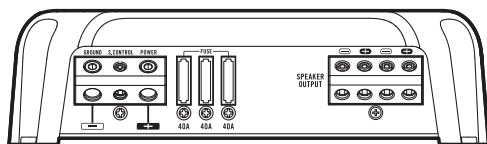

To adjust the switch, use a flathead screwdriver if needed.

① POWER/PROTECT indicator

The power indicator lights up to indicate power ON.

- If something is not normal, the indicator turns red.

② GAIN (gain) control

If the output remains low, even when the car stereo volume is turned up, turn the controls to a lower level. If distortion occurs

when the car stereo volume is turned up, turn these controls to a higher level.

- For use with an RCA equipped car stereo (standard output of 500 mV), set to the **NORMAL** position. For use with an RCA equipped Pioneer car stereo, with maximum output of 4 V or more, adjust level to match that of the car stereo output.
- For use with an RCA equipped car stereo with output of 4 V, set to the **H** position.
- If you hear too much noise when using the speaker input terminals, turn the gain control to higher level.

③ LPF (low-pass filter) cut off frequency control

You can select a cut off frequency from 40 Hz to 240 Hz.

④ BASS BOOST REMOTE (bass boost level remote control) jack

By connecting the Bass boost level remote control to the jack on the main unit, you will be able to select a bass boost level from 0 dB to 18 dB.

For instruction of connecting the bass boost remote control to the amplifier, see the *Connection diagram*. 

Setting gain properly

- Protective function included to prevent malfunction of the unit and/or speakers due to excessive output, improper use or improper connection.
- When outputting high volume sound etc., this function cuts off the output for a few seconds as a normal function, but output is restored when the volume of the head unit is turned down.

Setting the unit

- A cut in sound output may indicate improper setting of the gain control. To ensure continuous sound output with the head unit at a high volume, set amplifier gain control to a level appropriate for the preout maximum output level of the head unit, so that volume can remain unchanged and to control excess output.
- Despite correct volume and gain settings, the unit sound still cuts out periodically. In such cases, please contact the nearest authorized Pioneer Service Station.

Gain control of this unit

Preout level: 2 V (Standard: 500 mV)

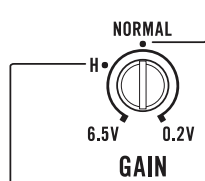

Preout level: 4 V

Above illustration shows **NORMAL** gain setting.

Relationship between amplifier gain and head unit output power

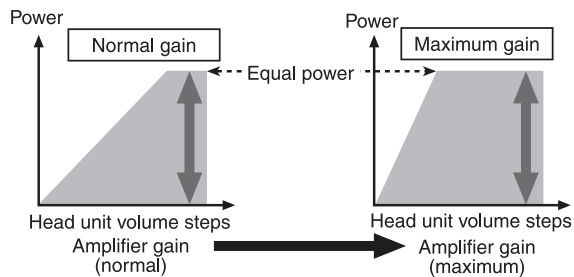

If amplifier gain is raised improperly, this will simply increase distortion, with little increase in power.

Signal waveform when outputting at high volume using amplifier gain control

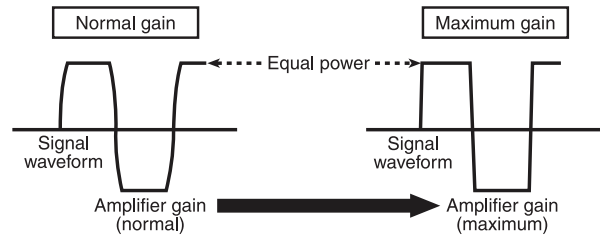

If the signal waveform is distorted due to high output, even if the amplifier gain is raised, the output power will change only slightly. ▣

Connecting the units

Connection diagram

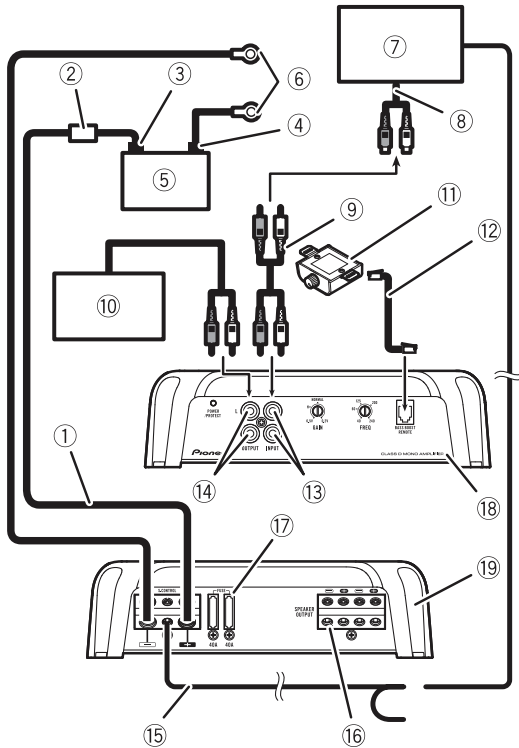

- ① Battery wire (sold separately)
 - The maximum length of the wire between the fuse and the positive \oplus terminal of the battery is 30 cm (12 in.).
 - For the wire size, refer to *Connecting the power terminal*. The battery wire, the ground wire and the optional direct ground wire must be same size. After making all other connections at the amplifier, connect the battery wire terminal of the amplifier to the positive \oplus terminal of the battery.
- ② Fuse 100 A (GM-D8701 and GM-DX871) / 150 A (GM-D9701 and GM-DX971) (sold separately)
Each amplifier must be separately fused at 100 A (GM-D8701 and GM-DX871) / 150 A (GM-D9701 and GM-DX971).
- ③ Positive \oplus terminal
- ④ Negative (\ominus) terminal
- ⑤ Battery (sold separately)
- ⑥ Ground wire, Terminal (sold separately)
The ground wires must be same size as the battery wire.

- ⑦ Connect to metal body or chassis.
- ⑦ Car stereo with RCA output jacks (sold separately)
- ⑧ External output
- ⑨ Connecting wire with RCA pin plugs (sold separately)
- ⑩ Amplifier with RCA input jacks (sold separately)
- ⑪ Bass boost level remote control
- ⑫ Bass boost level remote control wire (5 m (16 ft. 5 in.))
- ⑬ RCA input jack
- ⑭ RCA output jack
- ⑮ System remote control wire (sold separately)
Connect male terminal of this wire to the system remote control terminal of the car stereo. The female terminal can be connected to the auto-antenna relay control terminal. If the car stereo lacks a system remote control terminal, connect the male terminal to the power terminal via the ignition switch.
- ⑯ Speaker output terminals
Please see the following section for speaker connection instructions. Refer to *Connections when using the speaker input wire*.
- ⑰ Fuse 40 A \times 2 (GM-D8701 and GM-DX871) / 40 A \times 3 (GM-D9701 and GM-DX971)
- ⑱ Front side
- ⑲ Rear side

Before connecting the amplifier

! WARNING

- Secure the wiring with cable clamps or adhesive tape. To protect the wiring, wrap sections in contact with metal parts in adhesive tape.
- Never cut the insulation of the power supply to feed power to other equipment. Current capacity of the wire is limited.

! CAUTION

- Never shorten any wires, the protection circuit may malfunction.

Connecting the units

- Never wire the speaker negative cable directly to ground.
- Never band together multiple speaker's negative cables.
- If the system remote control wire of the amplifier is connected to the power terminal via the ignition switch (12V DC), the amplifier will remain on with the ignition whether the car stereo is on or off, which may exhaust battery if the engine is at rest or idling.
- Install and route the separately sold battery wire as far as possible from the speaker wires. Install and route the separately sold battery wire, ground wire, speaker wires and the amplifier as far away as possible from the antenna, antenna cable and tuner. ▣

Connecting the speakers

This amplifier can be connected to two speakers in parallel. Connect the speaker leads to suit the mode according to the figure shown below.

Precautions for parallel connection

- When wiring two speakers in parallel, make sure that the synthetic impedance is from $1\ \Omega$ to $8\ \Omega$ to prevent the amplifier from catching fire, generating smoke and/or being damaged.
- When connected in parallel with the synthetic impedance less than $1\ \Omega$, as a normal function, this amplifier may automatically be set on mute if outputting high volume sound. Turn down the volume until the mute function is canceled. ▣

When connecting to one speaker

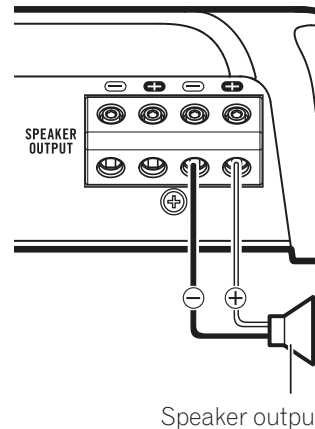

Speaker output

When connecting to two speakers

The output from two speakers is the same as that of one speaker.

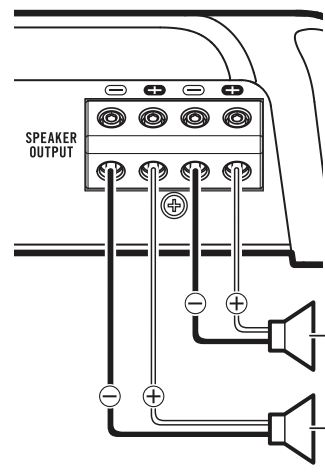

Speaker output



Connecting the units

Connections when using the speaker input wire

Connect the car stereo speaker output wires to the amplifier using the supplied speaker input wire with RCA pin cord.

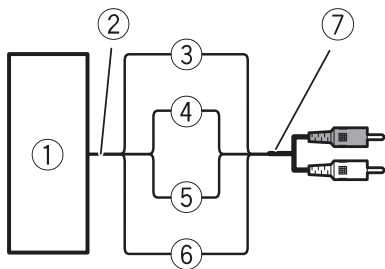

- ① Car Stereo
- ② Speaker output
- ③ Red: Right ⊕
- ④ Black: Right ⊖
- ⑤ Black: Left ⊖
- ⑥ White: Left ⊕
- ⑦ Speaker input wire with RCA pin cord
To the RCA input jack of this unit

Notes

- If speaker input wires from a headunit are connected to this amplifier, the amplifier will automatically turn on when the headunit is turned on. When the headunit is turned off, the amplifier turns off automatically. This function may not work with some headunits. In such cases, please use a system remote control wire (sold separately). If multiple amplifiers are to be connected together synchronously, connect the head unit and all amplifiers via the system remote control wire.
- Connect the system remote control wire when you wish to only turn on the car stereo, not the amplifier.
- This amplifier automatically selects an input signal mode between the RCA level and the speaker level by detecting an input signal.

Solderless terminal connections

- Since the wire will become loose over time, it must be periodically inspected and tightened as necessary.
- Do not solder or bind the ends of the twisted wires.
- Fasten while making sure to not to clamp the insulating sheath of the wire.
- Use the supplied hexagonal wrench to tighten and loosen the terminal screw of the amplifier and use it to securely fasten the wire. Be careful to avoid excessive tightening of this screw, which may damage the wire.

Connecting the power terminal

⚠ WARNING

If the battery wire is not securely fixed to the terminal using the terminal screws, there is a risk of overheating, malfunction and injury, including minor burns.

- Always use the recommended battery and ground wire, which is sold separately. Connect the battery wire directly to the car battery positive (⊕) terminal and the ground wire to the car body.
- Recommended wires size (AWG: American Wire Gauge) is as follows. The battery wire, the ground wire and the optional direct ground wire must be same size.
- Use a wire of 8 AWG to 16 AWG wire for the speaker wire.

Battery wire and ground wire size

Wire length	Wire size
less than 3.6 m (11 ft. 10 in.)	6 AWG
less than 6.4 m (20 ft. 12 in.)	4 AWG

Connecting the units



1 Route battery wire from engine compartment to the vehicle interior.

- When drilling a cable pass-hole into the vehicle body and routing a battery wire thorough it, take care not to short-circuit the wire damaging it by the cut edges or burrs of the hole.

After completing all other amplifier connections, finally connect the battery wire terminal of the amplifier to the positive ⊕ battery terminal.

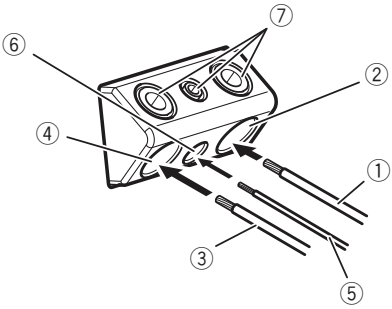

- ① Battery wire
- ② Power terminal
- ③ Ground wire
- ④ GND terminal
- ⑤ System remote control wire
- ⑥ System remote control terminal
- ⑦ Terminal screws

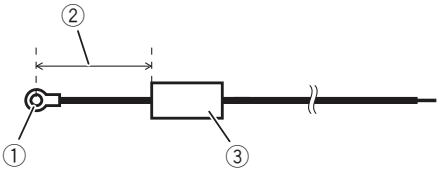

- ① Positive ⊕ terminal
- ② Battery wire (sold separately)
The maximum length of the wire between the fuse and the positive ⊕ terminal of the battery is 30 cm (12 in.).
- ③ Fuse 100 A (GM-D8701 and GM-DX871) / 150 A (GM-D9701 and GM-DX971) (sold separately)
Each amplifier must be separately fused at 100 A (GM-D8701 and GM-DX871) / 150 A (GM-D9701 and GM-DX971).

2 Use wire cutters or a utility knife to strip the end of the battery wire, ground wire and system remote control wire to expose about 10 mm (3/8 in.) of the end of each of the wires, and then twist the exposed ends of the wires.

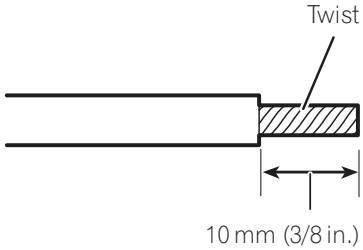

3 Connect the wires to the terminal.

Fix the wires securely with the terminal screws.

Connecting the units

Connecting the speaker output terminals

1 Use wire cutters or a utility knife to strip the end of the speaker wires to expose about 10 mm (3/8 in.) of wire and then twist the wire.

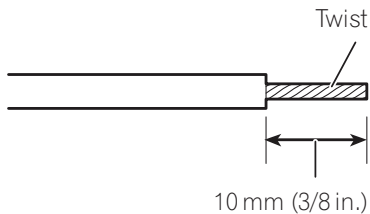

2 Connect the speaker wires to the speaker output terminals.

Fix the wires securely with the terminal screws.

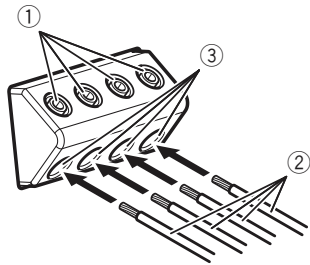

- ① Terminal screws
- ② Speaker wires
- ③ Speaker output terminals

Installation

Before installing the amplifier

! WARNING

- To ensure proper installation, use the supplied parts in the manner specified. If any parts other than those supplied are used, they may damage internal parts of the amplifier, or become loose causing the amplifier to shut down.
- Do not install in:
 - Places where it could injure the driver or passengers if the vehicle stops suddenly.
 - Places where it may interfere with the driver, such as on the floor in front of the driver's seat.
- Install tapping screws in such a way that the screw tip does not touch any wire. This is important to prevent wires from being cut by vibration of the car, which can result in fire.
- Make sure that wires do not get caught in the sliding mechanism of the seats or touch the legs of a person in the vehicle as short-circuit may result.
- When drilling to install the amplifier, always confirm no parts are behind the panel and protect all cables and important equipment (e.g. fuel/brake lines, wiring) from damage.

! CAUTION

- To ensure proper heat dissipation of the amplifier, ensure the following during installation:
 - Allow adequate space above the amplifier for proper ventilation.
 - Do not cover the amplifier with a floor mat or carpet.
- Place all cables away from hot places, such as near the heater outlet.
- The optimal installation location differs depending on the car model. Secure the amplifier at a sufficiently rigid location.
- Check all connections and systems before final installation.
- After installing the amplifier, confirm that the spare tire, jack and tools can be easily removed.

Installation

Attaching the Bass boost remote control

Attach with tapping screws (3 mm × 10 mm (1/8 in. × 3/8 in.)) at an easily accessible location such as under the dashboard.

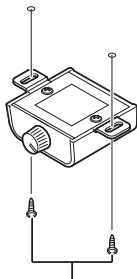

Tapping screws (3 mm × 10 mm (1/8 in. × 3/8 in.))



Example of installation on the floor mat or chassis

1 Place the amplifier in the desired installation location.

Insert the supplied tapping screws (4 mm × 18 mm (5/32 in. × 3/4 in.)) into the screw holes and push on the screws with a screwdriver so they make an imprint where the installation holes are to be located.

2 Drill 2.5 mm (3/32 in.) diameter holes at the imprints either on the carpet or directly on the chassis.

3 Install the amplifier with the use of supplied tapping screws (4 mm × 18 mm (5/32 in. × 3/4 in.)).

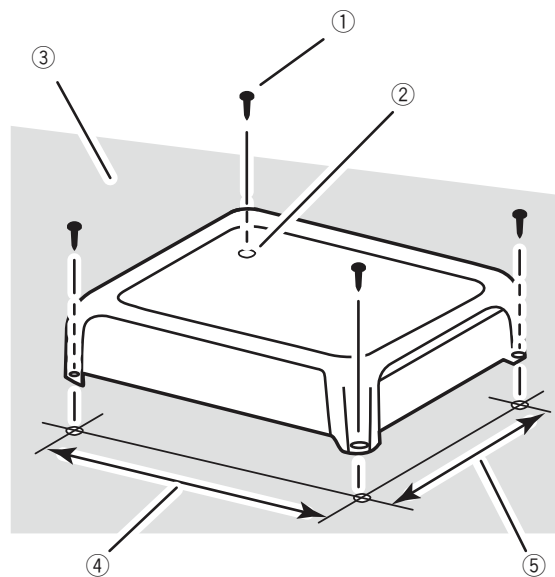

- ① Tapping-screws (4 mm × 18 mm (5/32 in. × 3/4 in.))
- ② Drill a 2.5 mm (3/32 in.) diameter hole.
- ③ Floor mat or chassis
- ④ Hole-to-hole distance: 229.5 mm (9-1/32 in.) (GM-D8701 and GM-DX871) / 279.5 mm (11 in.) (GM-D9701 and GM-DX971)
- ⑤ Hole-to-hole distance: 191.5 mm (7-17/32 in.) 

Additional information

Specifications

GM-D8701 and GM-DX871

Power source	14.4 V DC (10.8 V to 15.1 V allowable)
Grounding system	Negative type
Current consumption	22 A (at continuous power, 4 Ω)
Average current consumption	2.4 A (4 Ω for one channel) 3.6 A (2 Ω for one channel) 5.7 A (1 Ω for one channel)
Fuse	40 A \times 2
Dimensions (W \times H \times D) ...	252 mm \times 60 mm \times 215 mm (9-7/8 in. \times 2-3/8 in. \times 8-1/2 in.)
Weight	2.7 kg (6 lbs) (Leads for wiring not included)
Maximum power output	600 W \times 1 (4 Ω) / 1 600 W \times 1 (1 Ω)
Continuous power output ...	300 W \times 1 (at 14.4 V, 4 Ω , 20 Hz to 240 Hz, \leq 1% THD) 500 W \times 1 (at 14.4 V, 2 Ω , 100 Hz, \leq 1% THD) 800 W \times 1 (at 14.4 V, 1 Ω , 100 Hz, \leq 1% THD)
Load impedance	4 Ω (1 Ω to 8 Ω allowable)
Frequency response	10 Hz to 240 Hz (+0 dB, -3 dB)
Signal-to-noise ratio	100 dB (IHF-A network)
Low pass filter:	
Cut off frequency	40 Hz to 240 Hz
Cut off slope	-12 dB/oct
Bass boost:	
Frequency	50 Hz
Level	0 dB to 18 dB
Gain control:	
RCA	200 mV to 6.5 V
Speaker	0.8 V to 16 V
Maximum input level / impedance:	
RCA	6.5 V / 25 k Ω
Speaker	16 V / 12 k Ω

CEA2006 Specifications



Power output	300 W RMS \times 1 Channel (at 14.4 V, 4 Ω , 20 Hz to 240 Hz and \leq 1% THD+N) 500 W RMS \times 1 Channel (at 14.4 V, 2 Ω , 100 Hz and \leq 1% THD+N) 800 W RMS \times 1 Channel (at 14.4 V, 1 Ω , 100 Hz and \leq 1% THD+N)
S/N ratio	75 dBa (reference: 1 W into 4 Ω)

GM-D9701 and GM-DX971

Power source	14.4 V DC (10.8 V to 15.1 V allowable)
Grounding system	Negative type
Current consumption	38 A (at continuous power, 4 Ω)
Average current consumption	3.5 A (4 Ω for one channel) 5.1 A (2 Ω for one channel) 7.5 A (1 Ω for one channel)
Fuse	40 A \times 3
Dimensions (W \times H \times D) ...	302 mm \times 60 mm \times 215 mm (11-7/8 in. \times 2-3/8 in. \times 8-1/2 in.)
Weight	3.1 kg (6.8 lbs) (Leads for wiring not included)
Maximum power output	1 000 W \times 1 (4 Ω) / 2 400 W \times 1 (1 Ω)
Continuous power output ...	500 W \times 1 (at 14.4 V, 4 Ω , 20 Hz to 240 Hz, \leq 1% THD) 800 W \times 1 (at 14.4 V, 2 Ω , 100 Hz, \leq 1% THD) 1 200 W \times 1 (at 14.4 V, 1 Ω , 100 Hz, \leq 1% THD)
Load impedance	4 Ω (1 Ω to 8 Ω allowable)
Frequency response	10 Hz to 240 Hz (+0 dB, -3 dB)
Signal-to-noise ratio	100 dB (IHF-A network)
Low pass filter:	
Cut off frequency	40 Hz to 240 Hz
Cut off slope	-12 dB/oct
Bass boost:	
Frequency	50 Hz
Level	0 dB to 18 dB
Gain control:	
RCA	200 mV to 6.5 V
Speaker	0.8 V to 16 V
Maximum input level / impedance:	
RCA	6.5 V / 25 k Ω

Additional information

Speaker 16 V / 12 k Ω

CEA2006 Specifications



Power output 500 W RMS \times 1 Channel (at
14.4 V, 4 Ω , 20 Hz to 240 Hz
and \leq 1 % THD+N)
800 W RMS \times 1 Channel (at
14.4 V, 2 Ω , 100 Hz and \leq 1 %
THD+N)
1 200 W RMS \times 1 Channel
(at 14.4 V, 1 Ω , 100 Hz and \leq
1 % THD+N)
S/N ratio 75 dBA (reference: 1 W into
4 Ω)

Notes

- Specifications and the design are subject to modifications without notice.
- The average current consumption is nearly the maximum current consumption by this unit when an audio signal is input. Use this value when working out total current consumption by multiple power amplifiers.

*Register your product at
Enregistrez votre produit au
Registre su producto en*

<http://www.pioneerelectronics.com>

*in Canada
au Canada
en Canadá*

<http://www.pioneerelectronics.ca>

PIONEER CORPORATION

28-8, Honkomagome 2-chome, Bunkyo-ku,
Tokyo 113-0021, JAPAN

PIONEER ELECTRONICS (USA) INC.

P.O. Box 1540, Long Beach, California 90801-1540, U.S.A.
TEL: (800) 421-1404

PIONEER EUROPE NV

Haven 1087, Keetberglaan 1, B-9120 Melsele, Belgium/Belgique
TEL: (0) 3/570.05.11

PIONEER ELECTRONICS ASIACENTRE PTE. LTD.

2 Jalan Kilang Barat, #07-01, Singapore 159346
TEL: 65-6378-7888

PIONEER ELECTRONICS AUSTRALIA PTY. LTD.

5 Arco Lane, Heatherton, Victoria, 3202 Australia
TEL: (03) 9586-6300

PIONEER ELECTRONICS DE MÉXICO S.A. DE C.V.

Blvd.Manuel Ávila Camacho 138, 10 piso
Col.Lomas de Chapultepec, México, D.F. 11000
TEL: 52-55-9178-4270
FAX: 52-55-5202-3714

先鋒股份有限公司

台北市內湖區瑞光路407號8樓
電話：886-(0) 2-2657-3588

先鋒電子（香港）有限公司

香港九龍長沙灣道909號5樓
電話：852-2848-6488

© 2018-2020 PIONEER CORPORATION.
All rights reserved.

© 2018-2020 PIONEER CORPORATION.
Tous droits de reproduction et de traduction
réservés.