

Jockford Fosgate®

POWER™

4 CHANNEL

Amplifiers

T400-4

T600-4

Installation & Operation

Installation et fonctionnement
Instalación y funcionamiento
Einbau und Betrieb
Installazione e funzionamento

INTRODUCTION

Dear Customer,

Congratulations on your purchase of the world's finest brand of car audio amplifiers. At Rockford Fosgate we are fanatics about musical reproduction at its best, and we are pleased you chose our product. Through years of engineering expertise, hand craftsmanship and critical testing procedures, we have created a wide range of products that reproduce music with all the clarity and richness you deserve.

For maximum performance we recommend you have your new Rockford Fosgate product installed by an Authorized Rockford Fosgate Dealer, as we provide specialized training through Rockford Technical Training Institute (RTTI). Please read your warranty and retain your receipt and original carton for possible future use.

Great product and competent installations are only a piece of the puzzle when it comes to your system. Make sure that your installer is using 100% authentic installation accessories from Connecting Punch in your installation. Connecting Punch has everything from RCA cables and speaker wire to Power line and battery connectors. Insist on it! After all, your new system deserves nothing but the best.

To add the finishing touch to your new Rockford Fosgate image order your Rockford accessories, which include everything from T-shirts to jackets and hats.

To get a free brochure on Rockford Fosgate products and Rockford accessories, visit our web site at: **www.rockfordfosgate.com** or, in the U.S. call 1-800-669-9899 or FAX 1-800-398-3985. For all other countries, call +001-480-967-3565 or FAX +001-480-967-8132.

PRACTICE SAFE SOUND™

Continuous exposure to sound pressure levels over 100dB may cause permanent hearing loss. High powered auto sound systems may produce sound pressure levels well over 130dB. Use common sense and practice safe sound.

If, after reading your manual, you still have questions regarding this product, we recommend that you see your Rockford Fosgate dealer. If you need further assistance, you can call us direct at 1-800-669-9899. Be sure to have your serial number, model number and date of purchase available when you call.

The serial number can be found on the outside of the box. Please record it in the space provided below as your permanent record. This will serve as verification of your factory warranty and may become useful in recovering your unit if it is ever stolen.

Serial Number: _____

Model Number: _____

TABLE OF CONTENTS

Introduction	2	Operation	10-11
Safety Instructions	3	Remote Punch EQ (Option)	10
Design Features	4	Punch EQ	10
Installation	5-9	Adjusting Crossover Frequency	10
Installation Considerations	5	2/4 Channel Switch	10
Mounting Locations	5	Adjusting Gain	11
Battery and Charging	6	Troubleshooting	11-12
Wiring the System	6	Specifications	12
		Limited Warranty Information	13

NOTE: Review each section for more detailed information.

©2006 Rockford Corporation. All rights reserved.
Rockford Fosgate, the Rockford Fosgate logo, the POWER logo and the PUNCH logo are either registered trademarks or trademarks of Rockford Corporation.

GETTING STARTED

Welcome to Rockford Fosgate! This manual is designed to provide information for the owner, salesperson and installer. For those of you who want quick information on how to install this product, please turn to the **Installation Section** of this manual. Other information can be located by using the Table of Contents. We, at Rockford Fosgate, have worked very hard to make sure all the information in this manual is current. But, as we are constantly finding new ways to improve our product, this information is subject to change without notice.

SAFETY INSTRUCTIONS

WARNING

This symbol with “**WARNING**” is intended to alert the user to the presence of important instructions. Failure to heed the instructions will result in severe injury or death.

CAUTION

This symbol with “**CAUTION**” is intended to alert the user to the presence of important instructions. Failure to heed the instructions can result in injury or unit damage.

 **CAUTION:** To prevent injury and damage to the unit, please read and follow the instructions in this manual. We want you to enjoy this system, not get a headache.

 **CAUTION** If you feel unsure about installing this system yourself, have it installed by a qualified Rockford Fosgate technician.

 **CAUTION** Before installation, disconnect the battery negative (-) terminal to prevent damage to the unit, fire and/or possible injury.

CONTENTS OF CARTON

Either a Power T400-4, or T600-4, 4-Channel
Amplifier
Installation & Operation Manual

Mounting Hardware Kit

The hardware kit included with each amplifier contains the mounting hardware necessary to secure the amplifier to the vehicle.

Visit our web site for the latest information on all Rockford products.

www.rockfordfosgate.com

DESIGN FEATURES

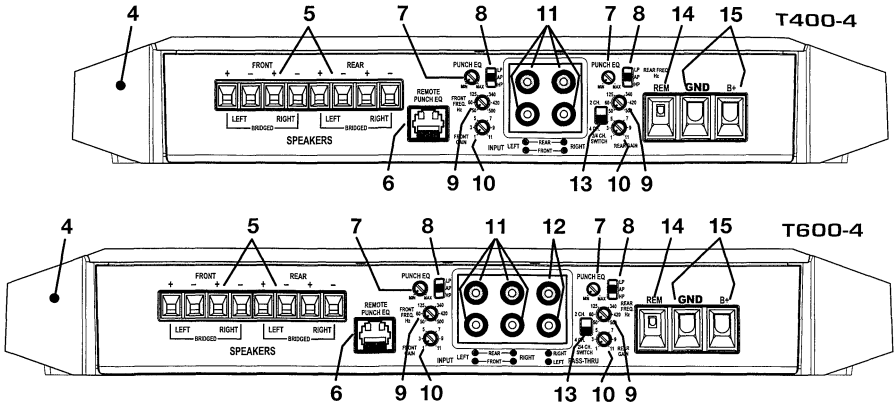

1. **Power LED (Top of unit - Not Shown)** – This Blue LED illuminates when the unit is turned on.
2. **Thermal LED (Top of unit - Not Shown)** – This Red LED illuminates if the amplifier internal components become too hot and engage the thermal protection. The amplifier will shut down to cool if this occurs.
3. **Protect LED (Top of unit - Not Shown)** – This Yellow LED illuminates if a short circuit or too low of an impedance is detected at the speaker connections. The amplifier will automatically shut down if this occurs.
4. **Cast Aluminum Heatsink** – The cast aluminum heatsink of the Power amplifier dissipates heat generated by the amplifier's circuitry.
5. **Speaker Terminals** – The heavy duty, nickel-plated clamp wire connectors (+ and -) will accept wire sizes from 8 AWG to 18 AWG.
6. **Remote Punch EQ (Optional Controller)** – The Remote Punch EQ connection is made with a RJ-45 cable and can be installed in a variety of ways for easy control access. The control is used to boost low and/or high frequency information to overcome road noise. The remote overrides the Punch EQ rear channel control on the amplifier when connected.
7. **Punch EQ** – A Gyrator based Punch EQ that eliminates frequency shift with boost. This works along with the crossover switch on the amplifier. When set to Low-Pass (LP) operation, this is a variable Bass Boost. When set to High-Pass (HP) operation, this is a variable Mid-Bass and Treble Boost. When set to All Pass (AP) operation, both the Bass and Treble frequencies are boosted.
8. **Crossover Switch** – Selectable switch for High-Pass (HP), All Pass (AP), or Low-Pass (LP) operation.
9. **Variable Crossover** – Is a built-in 24dB/octave Butterworth filter with a crossover point variable from 50Hz to 500Hz.
10. **Gain Control** – The input gain control is preset to match the output of most source units. It can be adjusted to match output levels from a variety of source units.
11. **RCA Input Jacks** – The industry standard RCA jacks provide an easy connection for signal level input. They are nickel-plated to resist the signal degradation caused by corrosion.
12. **RCA Pass-Thru Jacks (T600-4 Only)** – This Pass-Thru provides a convenient source for daisy-chaining an additional amplifier without running an extra set of RCA cables from the front of the vehicle to the rear amplifier location.
13. **2/4 Channel Switch** – Setting this switch to the 2CH. position, switches the inputs to a 2-channel mode, allowing connection to only the front inputs with a 4-channel output.
14. **REM Terminal** – The heavy duty, nickel-plated captive c-clamp wire connector will accept wire sizes from 12 AWG to 24 AWG. This terminal is used to remotely turn-on and turn-off the amplifier when +12V DC is applied.
15. **Power Terminals** – The power and ground are nickel-plated captive c-clamp wire connectors and will accommodate up to 4 AWG wire.

INSTALLATION CONSIDERATIONS

The following is a list of tools needed for installation:

Fuse-holder and fuse. (See specifications for fuse rating)	Battery post wrench
Volt/Ohm Meter	Hand held drill w/assorted bits
Wire strippers	1/8" diameter heatshrink tubing
Wire crimpers	Assorted connectors
Wire cutters	Adequate Length—Red Power Wire
#2 Phillips screwdriver	Adequate Length—Remote Turn-on Wire
	Adequate Length—Black Grounding Wire

NOTE: We recommend a 4 AWG wire for use on the power (B+) and ground (GND) connections.

This section focuses on some of the vehicle considerations for installing your new amplifier. Pre-planning your system layout and best wiring routes will save installation time. When deciding on the layout of your new system, be sure that each component will be easily accessible for making adjustments.

 **CAUTION:** If you feel unsure about installing this system yourself, have it installed by a qualified technician.

 **CAUTION:** Before installation, disconnect the battery negative (-) terminal to prevent damage to the unit, fire and/or possible injury.

Before beginning any installation, follow these simple rules:

1. Be sure to carefully read and understand the instructions before attempting to install the unit.
2. For safety, disconnect the negative lead from the battery prior to beginning the installation.
3. For easier assembly, we suggest you run all wires prior to mounting your unit in place.
4. Route all of the RCA cables close together and away from any high current wires.
5. Use high quality connectors for a reliable installation and to minimize signal or power loss.
6. Think before you drill! Be careful not to cut or drill into gas tanks, fuel lines, brake or hydraulic lines, vacuum lines or electrical wiring when working on any vehicle.
7. Never run wires underneath the vehicle. Running the wires inside the vehicle provides the best protection.
8. Avoid running wires over or through sharp edges. Use rubber or plastic grommets to protect any wires routed through metal, especially the firewall.
9. ALWAYS protect the battery and electrical system from damage with proper fusing. Install the appropriate fuse holder and fuse on the +12V power wire within 18" (45.7 cm) of the battery terminal.
10. When grounding to the chassis of the vehicle, scrape all paint from the metal to ensure a good, clean ground connection. Grounding connections should be as short as possible and always be connected to metal that is welded to the main body, or chassis, of the vehicle.

MOUNTING LOCATIONS***Engine Compartment***

Never mount this unit in the engine compartment. Mounting the unit in the engine compartment will void your warranty.

Trunk Mounting

Mounting the amplifier vertically or inverted will provide adequate cooling of the amplifier.

Mounting the amplifier on the floor of the trunk will provide the best cooling of the amplifier.

INSTALLATION

Passenger Compartment Mounting

Mounting the amplifier in the passenger compartment will work as long as you provide a sufficient amount of air for the amplifier to cool itself. If you are going to mount the amplifier under the seat of the vehicle, you must have at least 1" (2.54cm) of air gap around the amplifier's heatsink.

Mounting the amplifier with less than 1" (2.54cm) of air gap around the amplifier's heatsink in the passenger compartment will not provide proper cooling and will severely affect the performance of the amplifier and is strongly not recommended.

BATTERY AND CHARGING

Amplifiers will put an increased load on the vehicle's battery and charging system. We recommend checking your alternator and battery condition to ensure that the electrical system has enough capacity to handle the increased load of your stereo system. Stock electrical systems which are in good condition should be able to handle the extra load of any Power Series amplifier without problems, although battery and alternator life can be reduced slightly. To maximize the performance of your amplifier, we suggest the use of a heavy duty battery and an energy storage capacitor.

WIRING THE SYSTEM

⚠ CAUTION: If you do not feel comfortable with wiring your new unit, please see your local Authorized Rockford Fosgate Dealer for installation.

⚠ CAUTION: Before installation, disconnect the battery negative (-) terminal to prevent damage to the unit, fire and/or possible injury.

⚠ CAUTION: Avoid running power wires near the low level input cables, antenna, power leads, sensitive equipment or harnesses. The power wires carry substantial current and could induce noise into the audio system.

1. Plan the wire routing. Keep RCA cables close together but isolated from the amplifier's power cables and any high power auto accessories, especially electric motors. This is done to prevent coupling the noise from radiated electrical fields into the audio signal. When feeding the wires through the firewall or any metal barrier, protect them with plastic or rubber grommets to prevent short circuits. Leave the wires long at this point to adjust for a precise fit at a later time.

NOTE: We recommend a 4 AWG wire for use on the power (B+) and ground (GND) connections.

2. Prepare the RED wire (power cable) for attachment to the amplifier by stripping 5/8" of insulation from the end of the wire. Insert the bared wire into the B+ terminal and tighten the set screw to secure the cable in place.

NOTE: The B+ cable MUST be fused 18" or less from the vehicle's battery. Install the fuseholder under the hood and ensure connections are water tight.

3. Trim the RED wire (power cable) within 18" of the battery and splice in a inline fuse holder (not supplied). See Specifications for the rating of the fuse to be used. **DO NOT install the fuse at this time.**

4. Strip 1/2" from the battery end of the power cable and crimp a large ring terminal to the cable. Use the ring terminal to connect to the battery positive terminal.

5. Prepare the BLACK wire (Ground cable) for attachment to the amplifier by stripping 5/8" of insulation from the end of the wire. Insert the bare wire into the GROUND terminal and tighten the set screw to secure the cable in place. Prepare the chassis ground by scraping any paint from the metal surface and thoroughly clean the area of all dirt and grease. Strip the other end of the wire and attach a ring connector. Fasten the cable to the chassis using a non-anodized screw and a star washer.

NOTE: Keep the length of the BLACK wire (Ground) as short as possible. Always less than 30" (76.2cm).

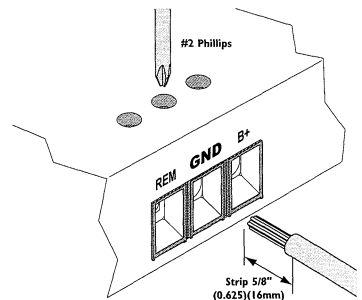

6. Prepare the Remote turn-on wire for for attachment to the amplifier by stripping 5/8" of insulation from the end of the wire. Insert the bared wire into the REMOTE terminal and tighten the set screw to secure the wire in place. Connect the other end of the Remote wire to a switched 12 volt positive source. The switched voltage is usually taken from the source unit's remote amp on lead. If the source unit does not have this output available, the recommended solution is to wire a mechanical switch in line with a 12 volt source to activate the amplifier.
7. Securely mount the amplifier to the vehicle or amp rack. Be careful not to mount the amplifier on cardboard or plastic panels. Doing so may enable the screws to pull out from the panel due to road vibration or sudden vehicle stops.
8. Connect from source signal by plugging the RCA cables into the input jacks at the amplifier.

NOTE: All "ACTIVE" inputs must have RCA jacks connected. Switch in 2CH. position, "ACTIVE" - Front channel inputs only. Switch in 4CH. position, "ACTIVE" - All Front and Rear channel inputs. When connecting to the 4-Channel inputs, be sure to route both front and rear RCA cables tightly together.

CAUTION: Always ensure power is off or disconnected at the amplifier before connecting RCA cables. Failure to do so may cause injury, damage to the amplifier and/or connected components.

9. Connect the speakers. Strip the speaker wires 1/2" and insert into the speaker terminal and tighten the set screw to secure into place. Be sure to maintain proper speaker polarity. DO NOT chassis ground any of the speaker leads as unstable operation may result.
10. Perform a final check of the completed system wiring to ensure that all connections are accurate. Check all power and ground connections for frayed wires and loose connections which could cause problems. Install inline fuse near battery connection.

NOTE: Follow the diagrams for proper signal polarity.

Power Connection

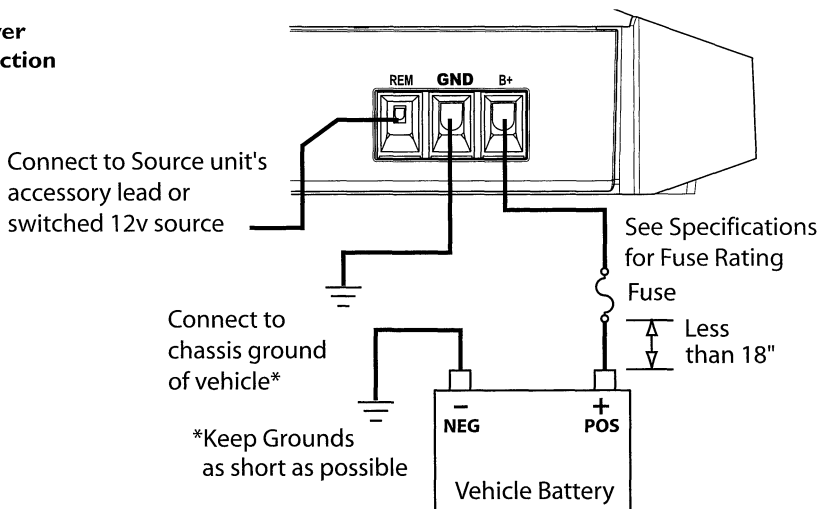

2-Channel Wiring

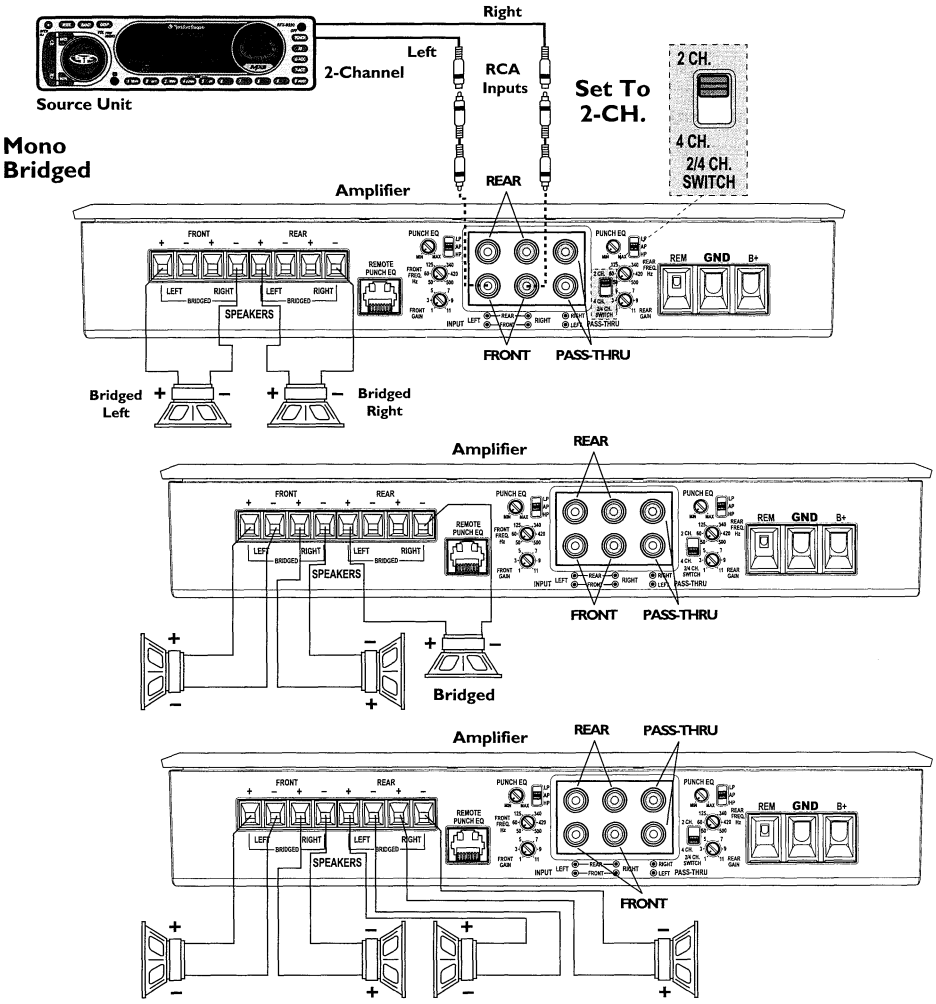

- **RCA Inputs** connect to FRONT inputs only.
- **2/4 CH. SWITCH** up position to set to 2 CH.
- **Gain (Front & Rear)** - is set independently to suit application.
- **Crossover (Front & Rear)** - is set independently to suit application.

4-Channel Wiring

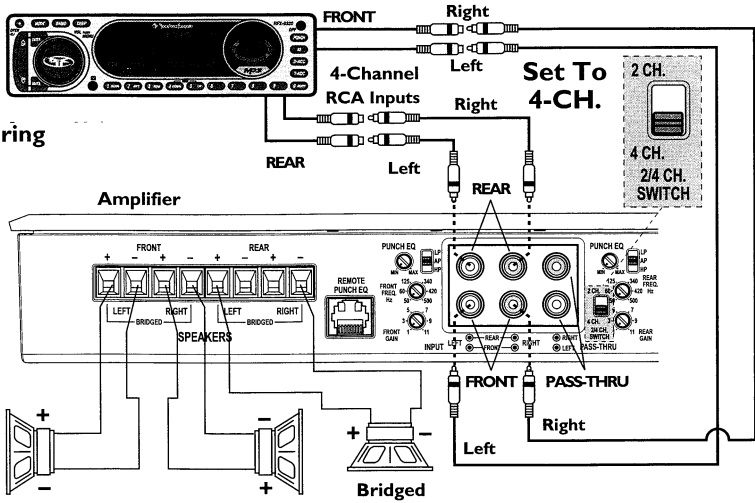

- **2/4 CH. SWITCH** down position to set to 4 CH.
- **Gain (Front & Rear)** - is set independently to suit application.
- **Crossover (Front & Rear)** - is set independently to suit application.

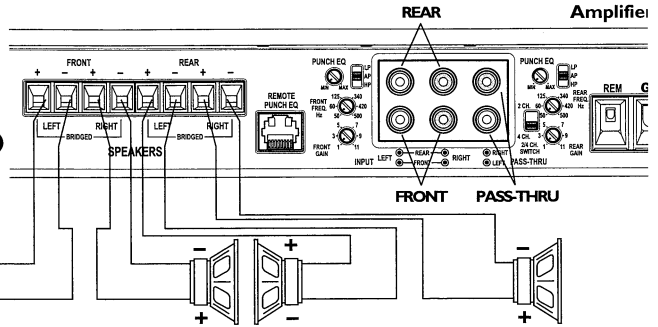

Stereo Bridged

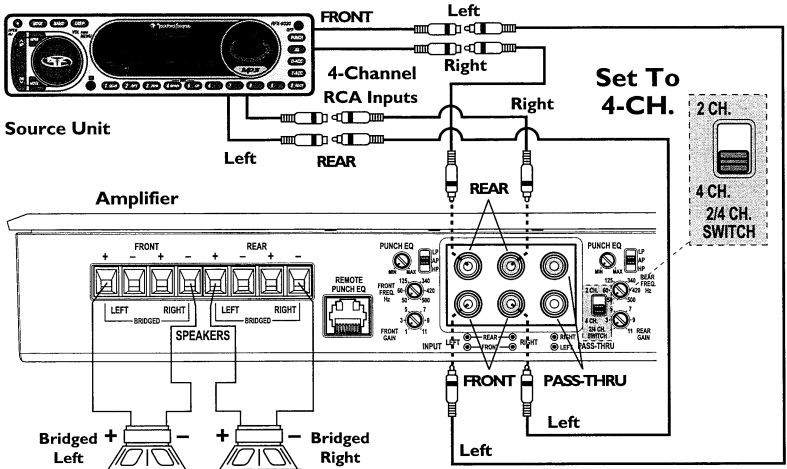

OPERATION

REMOTE PUNCH EQ (Optional)

NOTE: Use the instructions that came with the remote for a variety of mountings that fit your preference.

Quick Install

1. Using the screws supplied, install the mounting clip.
2. Slip the remote onto the mounting clip until it snaps into place.
3. Route and connect the cable to the remote and amplifier.

Operation

4. Operation works the same as Punch EQ, see below.

NOTE: Connecting the optional remote overrides the Punch EQ rear channel control on the amplifier.

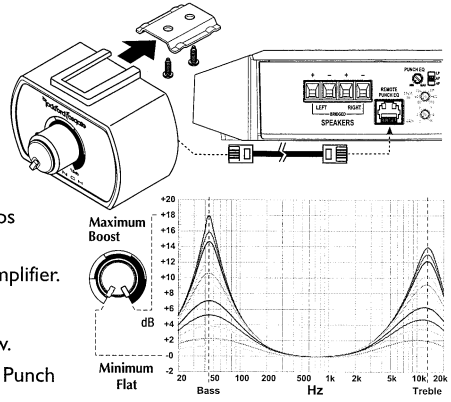

CAUTION: Overexcursion and subsequent damage may occur at high levels of boost.

PUNCH EQ

This works along with the crossover switch on the amplifier.

When set to Low-Pass (LP) operation, this is a variable Bass Boost.

When set to High-Pass (HP) operation, this is a variable Mid-Bass and Treble Boost.

When set to All Pass (AP) operation, both the Bass and Treble frequencies are boosted.

Set this to your personal preference while listening to the system.

NOTE: Connecting the optional remote overrides the Punch EQ rear channel control on the amplifier.

ADJUSTING CROSSOVER FREQUENCY

Do the following individually for each channel.

Placing the crossover switch in the HP position sets the amplifier to the High Pass mode, enabling frequencies above the cut-off point to pass, adjustable between 50-500Hz.

Placing the crossover switch in the AP position sets the amplifier to the All Pass mode, preventing any crossover adjustment, allowing all frequencies to pass.

Placing the crossover switch in the LP position sets the amplifier to the Low Pass mode, enabling frequencies below the cut-off point to pass, adjustable between 50-500Hz.

Turn the crossover adjustment knob all the way down. With the system playing, turn the crossover adjustment knob up slowly until the desired crossover point is achieved.

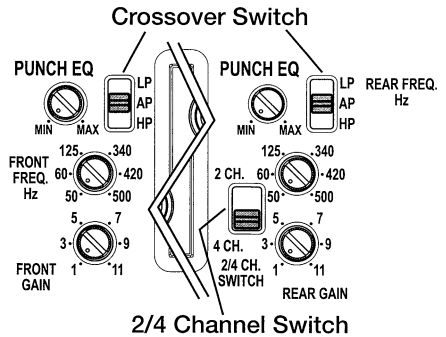

2/4 CHANNEL SWITCH

Setting this switch to the 2CH. position, switches the inputs to a 2-channel mode, allowing connection to only the front inputs with a 4-channel output.

Output controls function the same as if the amplifier was in 4-channel mode.

All "ACTIVE" inputs must have RCA jacks connected.

Switch in 2CH. position, "ACTIVE" - Front channel inputs only.

Switch in 4CH. position, "ACTIVE" - All Front and Rear channel inputs.

NOTE: When connecting to the 4-Channel inputs, be sure to route both front and rear RCA cables tightly together.

ADJUSTING GAIN

Do the following individually for each channel.

To adjust the gain setting, turn the amplifier gains all the way down (counter-clockwise). Turn the source unit volume up until distortion is audible and then turn it down a bit until the distortion is inaudible. This will be about all the way up on most source units. Next, increase the amplifier gain setting until adequate volume is achieved.

NOTE: Best signal to noise and dynamic range are realized with the gain at minimum. Most users find adequate gain and volume is achieved at about halfway in the adjustment range.

 **CAUTION:** Avoid setting the amplifier gain very high as noise and distortion will increase significantly.

NOTE: For a more in depth setting procedure, contact Rockford Technical Support.

TROUBLESHOOTING

NOTE: If you are having problems after installation follow the Troubleshooting procedures below.

Procedure 1: Check Amplifier for proper connections.

Verify that **POWER light is on**. If **POWER light is on skip to Step 3, if not continue**.

1. Check in-line fuse on battery positive cable. Replace if necessary.
2. Check fuse(s) on amplifier. Replace if necessary.
3. Verify that Ground connection is connected to clean metal on the vehicle's chassis. Repair/replace if necessary.
4. Verify there is 9 to 16 Volts present at the positive battery and remote turn-on cable. Verify quality connections for both cables at amplifier, stereo, and battery/fuseholder. Repair/replace if necessary.

Procedure 2: Protect or Thermal light is on.

1. If the Protect light is on, this is a sign of a possible short in the speaker connections. Check for proper speaker connections and use an ohm meter to check for possible shorts in the speaker wiring. Too low of a speaker impedance may also cause Protect to light.
2. If the Thermal light is on, check for proper speaker impedance, rewire if needed. This can also be a sign of driving the amplifier at very high power levels without adequate airflow around the amplifier. Shut off the system and allow amplifier to cool. Check that the vehicle charging system is maintaining proper voltage. If the previous items do not solve the problem, a fault may be in the amplifier, call customer service for support.

Procedure 3: Check Amplifier for audio output.

1. Verify good RCA input connections at stereo and amplifier. Check entire length of cables for kinks, splices, etc. Test RCA inputs for AC volts with stereo on. Repair/replace if necessary.
2. Disconnect RCA input from amplifier. Connect RCA input from test stereo directly to amplifier input.

Procedure 4: Check Amplifier if you experience Turn-on Pop.

1. Disconnect input signal to amplifier and turn amplifier on and off.
2. If the noise is eliminated, connect the REMOTE lead of amplifier to source unit with a delay turn-on module.

OR

1. Use a different 12 Volt source for REMOTE lead of amplifier (i.e. battery direct).
2. If the noise is eliminated, use a relay to isolate the amplifier from noisy turn-on output.

Procedure 5: Check Amplifier if you experience excess Engine Noise.

1. Route all signal carrying wires (RCA, Speaker cables) away from power and ground wires.

OR

TROUBLESHOOTING

2. Bypass any and all electrical components between the stereo and the amplifier(s). Connect stereo directly to input of amplifier. If noise goes away the unit being bypassed is the cause of the noise.

OR

3. Remove existing ground wires for all electrical components. Reground wires to different locations. Verify that grounding location is clean, shiny metal free of paint, rust etc.

OR

4. Add secondary ground cable from negative battery terminal to the chassis metal or engine block of vehicle.

OR

5. Have alternator and battery load tested by your mechanic. Verify good working order of vehicle electrical system including distributor, spark plugs, spark plug wires, voltage regulator etc.

SPECIFICATIONS

MODEL- POWER	T400-4	T600-4
Continuous Power Rating (RMS) - Measured at 14.4 Battery Volts		
4Ω Load Per Channel	60 Watts x 4	100 Watts x 4
2Ω Load Per Channel	100 Watts x 4	150 Watts x 4
4Ω Load Bridged	200 Watts x 2	300 Watts x 2
2Ω Load Bridged	STABLE	STABLE
Dimensions: Height	2.14" (5.42cm)	2.14" (5.42cm)
Width	8.14" (20.68cm)	8.14" (20.68cm)
Length	13.66" (34.69cm)	14.91" (37.86cm)
Battery Fuse Rating (Amp) External (Not Supplied)	100A	150A
"A" Weighted Signal to Noise Ratio Referenced to 1 Watt into 4 ohms	≥85 dB	
"A" Weighted Signal to Noise Ratio Referenced to rated output into 4 ohms	≥105 dB	
Crossover Slope	24dB/octave Butterworth	
Crossover Frequency	variable from 50Hz to 500Hz	
Frequency Response	20Hz to 20KHz ±1dB	
Signal Voltage Adjustment Range	Variable from 150mV to 5V (RCA Input)	
Protection	NOMAD - Internal analog-computer output protection circuitry limits power in case of overload, plus short protection. Thermal switch shuts down the amplifier in case of overheating.	
Equalization PEQ (Punch Equalization)	Variable from 0dB to +18dB @ 45Hz and/or 0dB to +12dB @ 12KHz	
Input Impedance	20K ohms	
Operating Voltage	9 to 16 Volts DC	
Balanced Inputs	Yes	
CMRR (Common Mode Rejection Ratio)	>55dB @ 1KHz	
Damping Factor	>200	
THD+N (Total Harmonic Distortion + Noise)	< 0.1 @ 2 ohm and < 0.05 @ 4 ohm	

These specifications are Amplifier Power Standard CEA-2006 Compliant

Specifications subject to change without notice

Rockford Corporation offers a limited warranty on Rockford Fosgate products on the following terms:

Length of Warranty

Source Units, Speakers, Signal Processors and PUNCH Amplifiers – 1 Year

POWER Amplifiers – 2 Years

Any Factory Refurbished Product – 90 days (receipt required)

What is Covered

This warranty applies only to Rockford Fosgate products sold to consumers by Authorized Rockford Fosgate Dealers in the United States of America or its possessions. Product purchased by consumers from an Authorized Rockford Fosgate Dealer in another country are covered only by that country's Distributor and not by Rockford Corporation.

Who is Covered

This warranty covers only the original purchaser of Rockford product purchased from an Authorized Rockford Fosgate Dealer in the United States. In order to receive service, the purchaser must provide Rockford with a copy of the receipt stating the customer name, dealer name, product purchased and date of purchase.

Products found to be defective during the warranty period will be repaired or replaced (with a product deemed to be equivalent) at Rockford's discretion.

What is Not Covered

1. Damage caused by accident, abuse, improper operations, water, theft, shipping
2. Any cost or expense related to the removal or reinstallation of product
3. Service performed by anyone other than Rockford or an Authorized Rockford Fosgate Service Center
4. Any product which has had the serial number defaced, altered, or removed
5. Subsequent damage to other components
6. Any product purchased outside the U.S.
7. Any product not purchased from an Authorized Rockford Fosgate Dealer

Limit on Implied Warranties

Any implied warranties including warranties of fitness for use and merchantability are limited in duration to the period of the express warranty set forth above. Some states do not allow limitations on the length of an implied warranty, so this limitation may not apply. No person is authorized to assume for Rockford Fosgate any other liability in connection with the sale of the product.

How to Obtain Service

Contact the Authorized Rockford Fosgate Dealer you purchased this product from.

If you need further assistance, call 1-800-669-9899 for Rockford Customer Service. You **must** obtain an **RA# (Return Authorization number)** to return any product to Rockford Fosgate. You are responsible for shipment of product to Rockford.

EU Warranty

This product meets the current EU warranty requirements, see your Authorized dealer for details.

Rockford Fosgate®

Installation assistance available at:

RFTECH

www.rockfordfosgate.com/rftech



Rockford Fosgate

Rockford Corporation

546 South Rockford Drive

Tempe, Arizona 85281 U.S.A.

In U.S.A., (480) 967-3565 - Customer Service 1-800-669-9899

In Europe, Fax (49) 8503-934014

In Japan, Fax (81) 559-79-1265

www.rockfordfosgate.com

A M P L I F I E R

R O V E R



Performance Verification Certificate

Model :	T400-4	Rated Power :	400 Watts
Serial # :	6417625200-01	Tested By :	ARMANDO NEVAREZ
Birth Date :	01/09/07		

Engineering Inspection Data

CEA Test Voltage:	14.4V
Channel Separation:	-64.86dB
THD+N @ Rated Power:	.03%
Frequency Response:	PASS
Speaker Short Protection:	PASS
Thermal Management:	PASS
Punch® EQ Circuit:	PASS
Final Inspection:	PASS

Actual Power

84.37 X 4 @ 4 Ohms
140.85 X 4 @ 2 Ohms
281.70 X 2 @ 4 Ohms

Specifications

actual power measured into 2 Ohm loads

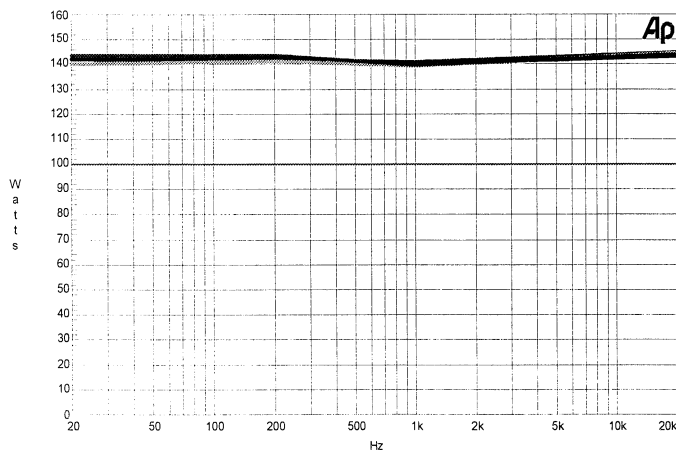

Total RMS Power
560.20

Power measured in accordance with CEA-2006 Specifications.

This Rockford Fosgate amplifier has been tested using state of the art equipment to ensure that it meets or exceeds its' rated specifications.

Are You Engineered to Rock, Or Wired for Stock?

Get a One Year Extended Warranty when you use matching Rockford Fosgate or Lightning Audio Amplifier Installation kit with this Amplifier!

We want you to get the performance and reliability that made Rockford Fosgate Amplifiers Famous. Using poor-quality under-spec wiring is a guaranteed way to get less than you paid for from your system.

We are so certain that getting your system wired to rock with the right wire and cables will make a difference, that we will give you an additional 1 year warranty on your amp when you use the matching amplifier installation kit. See your dealer to determine the matching kit for this amplifier.

To extend your warranty under this program attach the amplifier installation kit serial number sticker or the UPC code removed from the original amplifier installation kit package in the box below. Keep this form along with your original purchase receipt.

One warranty extension per amplifier regardless of the number of amplifier kits purchased.

What is covered:

This warranty applies only to Rockford Fosgate products sold to customers by Authorized Rockford Fosgate Dealers in the United States of America or its possessions. Product purchased by consumers from an Authorized Rockford Fosgate Dealer in another country is covered only by the country's Distributor and not by Rockford Corporation.

Who is covered:

This warranty covers only the original purchaser of Rockford product purchased from an Authorized Rockford Fosgate Dealer in the United States. In order to receive service, the purchaser must provide Rockford with a copy of the receipt stating the customer name, dealer name, product purchased and date of purchase. Products found to be defective during the warranty period will be repaired or replaced (with a product deemed to be equivalent) at Rockford's discretion.

What is not covered:

1. Damage caused by accident, abuse, improper operations, water, theft, shipping
2. Any cost or expense related to the removal or reinstallation of product
3. Service performed by anyone other than Rockford or an Authorized Rockford Fosgate Service Center
4. Any product which has had the serial number defaced, altered, or removed
5. Subsequent damage to other components
6. Any product purchased outside the U.S.
7. Any product not purchased from an Authorized Rockford Fosgate Dealer

Limit on Implied Warranties

Any implied warranties including warranties of fitness for use and merchantability are limited in duration to the period of the express warranty set forth above. Some states do not allow limitations in the length of an implied warranty, so this limitation may not apply. No person is authorized to assume for Rockford Fosgate any other liability in connection with the sale of the product.

How to Obtain Service Under the Extended Warranty Program:

The amplifier must be returned by the customer (you) or an authorized Rockford Fosgate retailer with a copy of the original receipt and the ORIGINAL Performance Verification Certificate with the amplifier installation kit serial number sticker, or the UPC code from the original amplifier installation kit package, attached.

Contact the Authorized Rockford Fosgate Dealer you purchased this product from. If you need further assistance, call 1-800-669-9899 for Rockford Customer Service. You must obtain an RA# (Return Authorization number) to return any product to Rockford Fosgate. You are responsible for shipment of product to Rockford.

EU Warranty

This product meets the current EU warranty requirements; see your Authorized dealer for details. "This Additional One-Year Warranty" is only available where allowed under local laws.

Attach Amplifier Installation Kit
Serial Number or UPC Code
from original packaging here.

PEQ

Patent Pending

Works with all 2007 Power® Amplifiers

NOTE: Previous Punch Bass and Para-Punch remotes will not work with these amplifiers.

With today's varying styles of music and multiple input sources, (i.e. MP3 players) the musical material can be lacking in bass and/or treble from song to song.

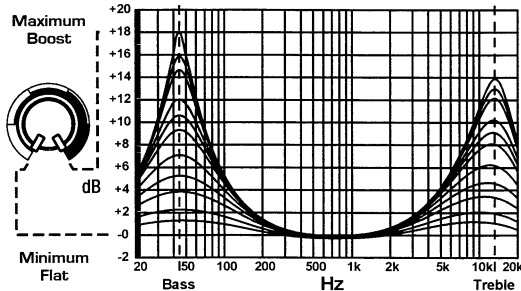
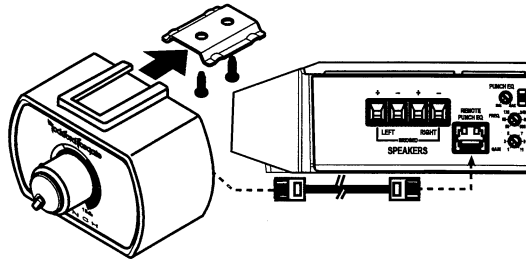

The remote Punch EQ is an equalizer for bass and treble that can be mounted anywhere in a vehicle. This remote control will automatically over-ride the amplifiers on-board EQ settings and deliver up to 3x the bass and/or treble at the touch of your fingertips.

Don't Forget...

- 1 **Capacitors** - Keep your amps stable and your speakers from distorting. Delivers more BASS!
- 2 **Distribution Blocks** - Use on main power wires to distribute power to multiple components.
- 3 **Power/Ground Wires** - High temperature, high strand count copper power and ground wires ensure maximum current transfer.
- 4 **Signal Cable** - Twisted construction eliminates noise for increased clarity and superior sound.
- 5 **Speaker Wire** - High strand count copper wires ensure maximum output.
- 6 **Crimp Rings & Spades** - Use on power and speaker wires for secure connections.

...Find Out More About These Products

www.rockfordfosgate.com/products

Rockford Fosgate